

SDG6000X

Series

Pulse/Arbitrary
Waveform Generator

Date Sheet- 2018.04

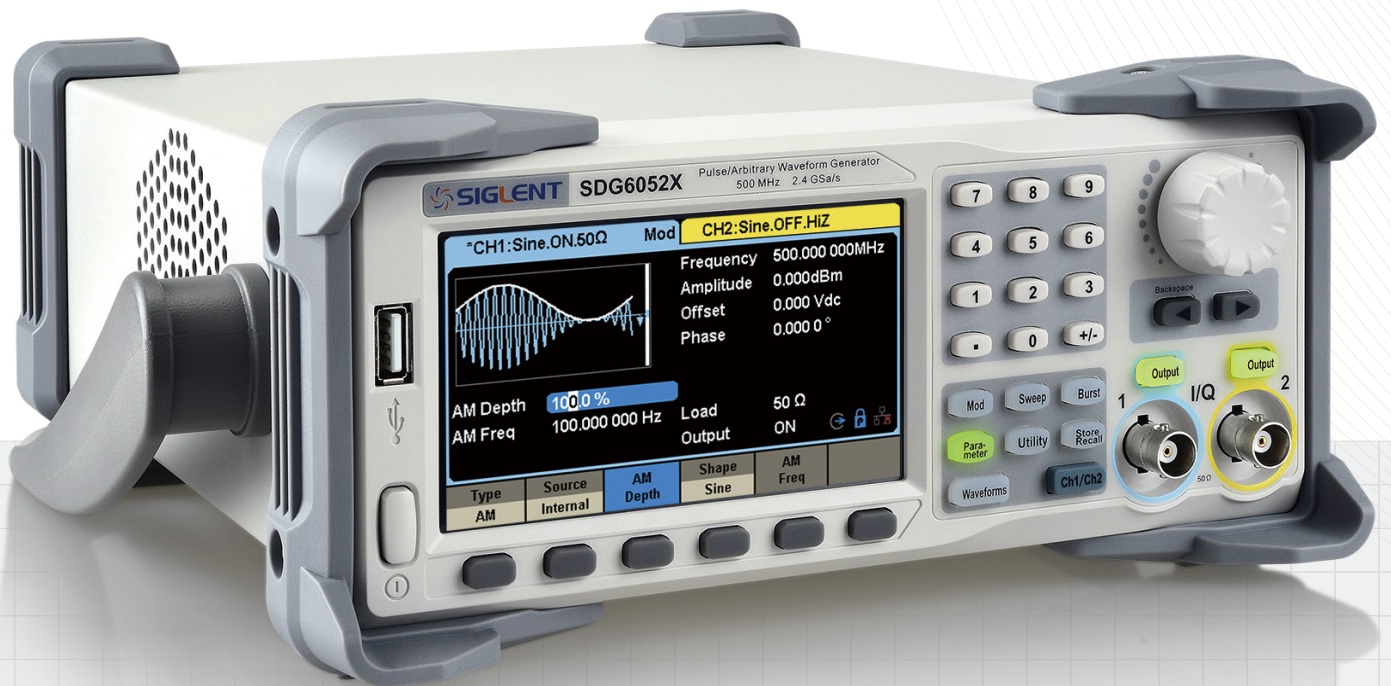

SDG6052X

SDG6032X

SDG6022X







Overview

SIGLENT's SDG6000X is a series of dual-channel Pulse/Arbitrary Waveform Generators that feature up to 500 MHz bandwidth, a maximum sample rate of 2.4 GSa/s and 16-bit vertical resolution. They also include proprietary TrueArb & EasyPulse technology that help to solve the weaknesses inherent in traditional DDS generators when generating arbitrary, square and pulse waveforms. In addition, the SDG6000X is a multi-function device which can generate Noise, IQ signals and PRBS patterns. These features enable the SDG6000X to provide a variety of high fidelity and low jitter signals, meeting the growing requirements of complex and intensive applications.



Key Features

- Dual-Channel, 500 MHz maximum bandwidth, 20 Vpp maximum output amplitude, high fidelity output with 80 dB dynamic range
- High-performance sampling system with 2.4 GSa/s sampling rate and 16-bit vertical resolution
- Multi-function signal generator, meeting requirements in wide range

	Sine Wave Generator	Continuous Wave Generator Up to 500 MHz sine wave, supporting sweep and user-defined harmonics. Low cost replacement of RF signal generators below 500 MHz
	Pulse Generator	Up to 150 MHz Pulse, with finely adjustable width, rising edge and falling edge; 3.3 ns minimum width and 1 ns minimum edge at full frequency range
	Function Arbitrary Waveform Generator	Basic Function/Arbitrary Waveform Generator and complex signals generating capability including modulation, sweep, burst and waveform combination.
	IQ Signal Generator (optional)	Base Band and IF IQ signals supporting basic modulation and an arbitrary symbol rate between 250 Symb/s ~ 37.5 MSymb/s
	Noise Generator	Up to 500 MHz bandwidth White Gaussian Noise with adjustable bandwidth
	PRBS Generator	Up to 300 Mbps PRBS3 ~ PRBS32 with fine bit rate and edge adjustments

- Sweep and Burst function
- Harmonics function
- Waveform Combining function
- Channel Coupling, Copy and Tracking function
- 196 built-in arbitrary waveforms
- High precision Frequency Counter
- Standard interfaces include: USB Host, USB Device (USBTMC), LAN (VXI-11, Socket, Telnet). Optional Interface: GPIB
- 4.3" touch screen display for easier operation

Model	SDG6022X	SDG6032X	SDG6052X
Bandwidth	200 MHz	350 MHz	500 MHz
Number of channels	2		
Sampling rate	2.4 GSa/s (2X Interpolation)		
Vertical resolution	16 bit		
Arbitrary waveform length	2 ~ 20 Mpts		
Display	4.3" touch screen display, 480 x 272 x RGB		
Interface	Standard: USB Host, USB Device, LAN Optional: GPIB (USB-GPIB adaptor)		

Characteristics

Continuous Wave

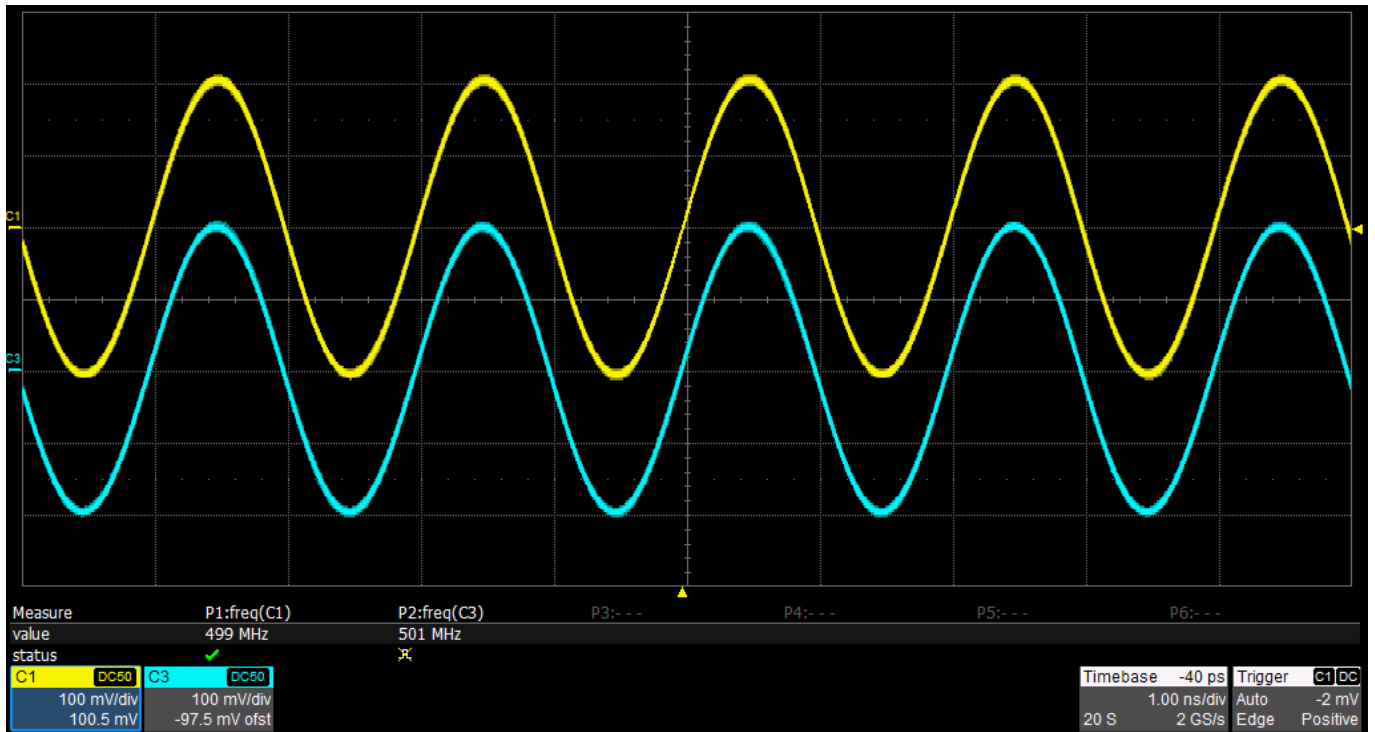

Up to 500MHz continuous sine wave.

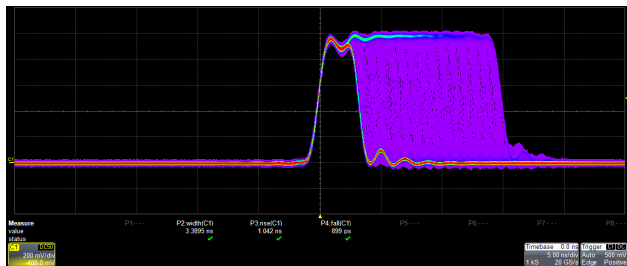

Pulse

Adjustable Pulse Width

The pulse width can be fine-tuned to the minimum of 3.3ns with an adjustment step as small as 100 ps, at any frequency.

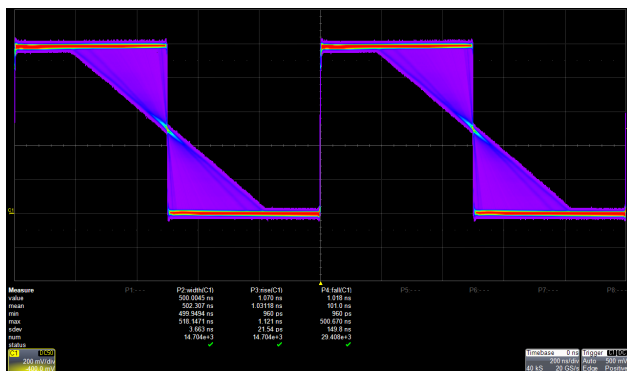

Adjustable Edge

The rise/fall times can be set independently to the minimum of 1ns at any frequency with a minimum adjustment step as small as 100 ps.



Low Jitter

When a Square/Pulse waveform is generated by traditional DDS, there can be additional jitter if the sampling rate is not an integer-related multiple of the output frequency. EasyPulse technology successfully overcomes this weakness in DDS designs and helps to produce low jitter Square/Pulse waveforms.

Arbitrary Waveform

Traditional DDS designs can lead to additional jitter and distortion when sourcing arbitrary waveforms. The SIGLENT TrueArb design minimizes jitter and distortion to help deliver high fidelity arbitrary waveforms.

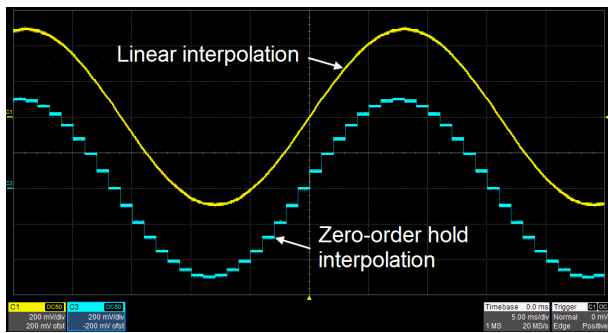

Point by Point Output

TrueArb generates arbitrary waveforms point-by-point. It never skips any point so that it can reconstruct all the details of the waveform, as defined. Two interpolation modes are available: linear and zero-order hold.

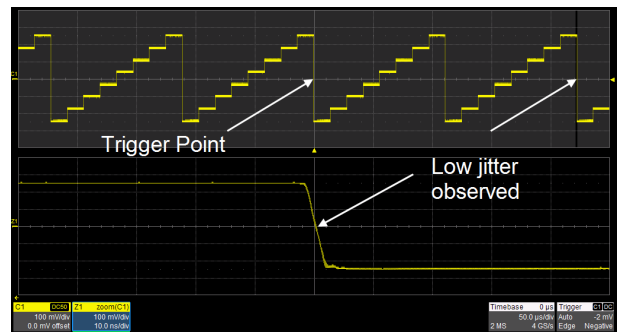

Low Jitter

As with EasyPulse, TrueArb effectively overcomes the clock jitter that can effect traditional DDS generators.

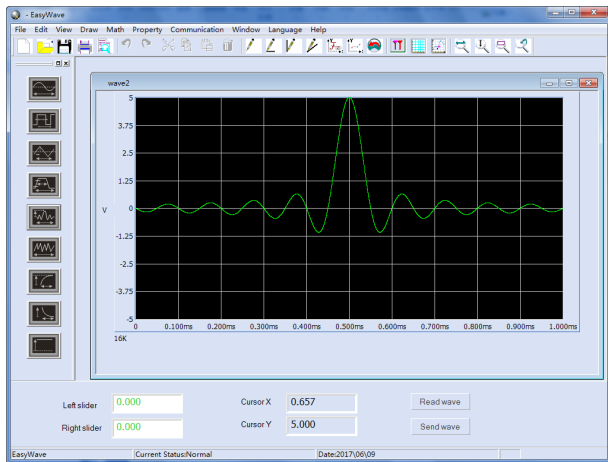

Arbitrary Waveform Software EasyWave

EasyWave is an arbitrary waveform software platform that supports waveform creation and editing. It features manual drawing, as-well-as line, equation, and coordinate editing modes. It is also a convenient way for users to edit their own arbitrary waveforms.

Noise

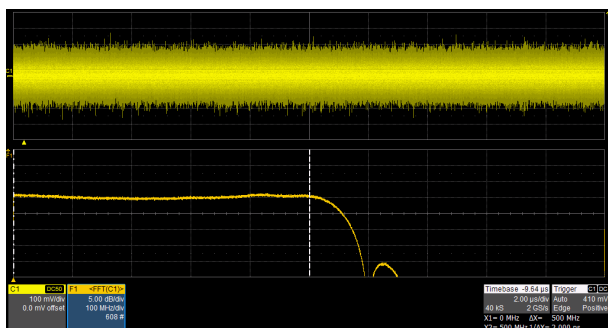

Gaussian noise with bandwidth up to 500 MHz. The repetition period is more than 100 years, and the bandwidth is adjustable.

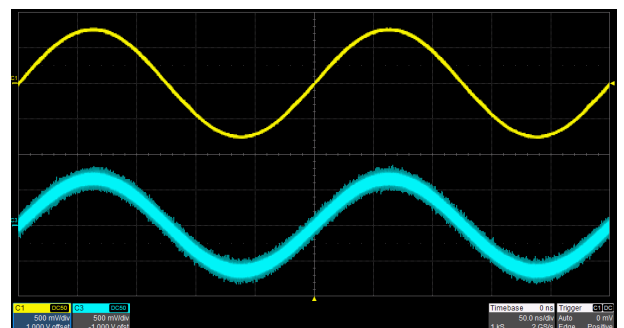

Wideband Gaussian noise can be easily added to other waveforms to simulate real-world scenarios in which the signal contains a large degree of noise.

IQ (optional)

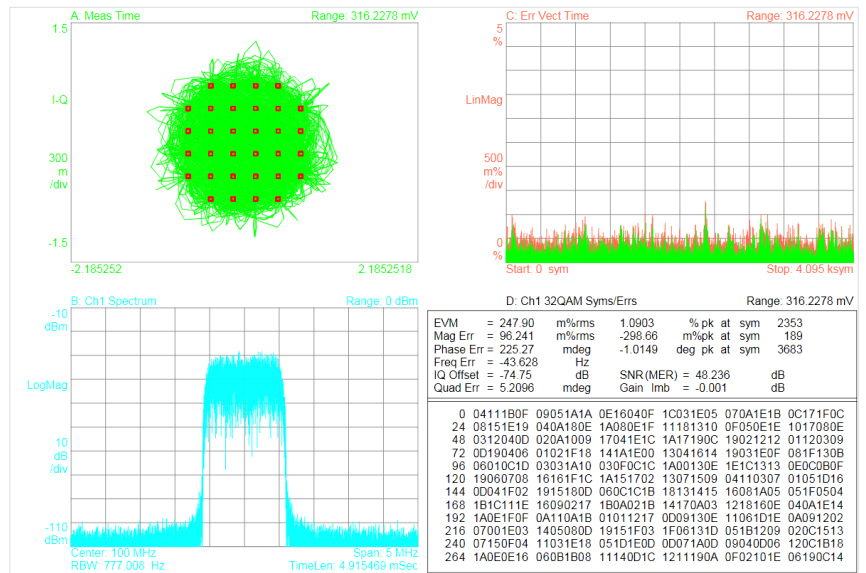
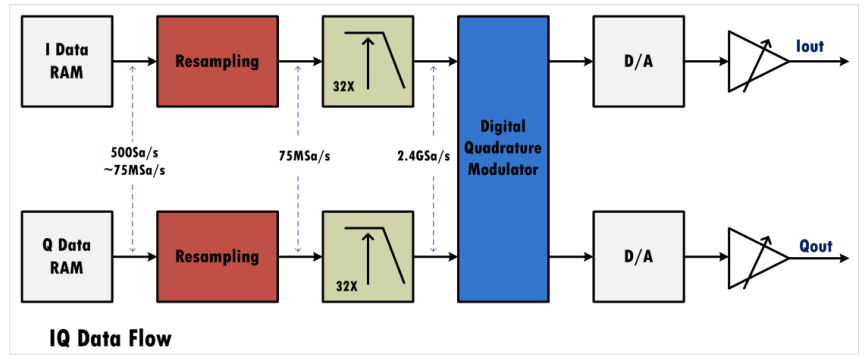

The SDG6000X supports popular modulation types such as ASK, FSK, PSK, and QAM. Proprietary resampling technology provides excellent EVM performance at arbitrary symbol rates between 250 Symb/s ~ 37.5 MSymb/s. Built-in digital quadrature modulator provides the possibility to generate IQ signals from baseband to 500 MHz intermediate frequency.

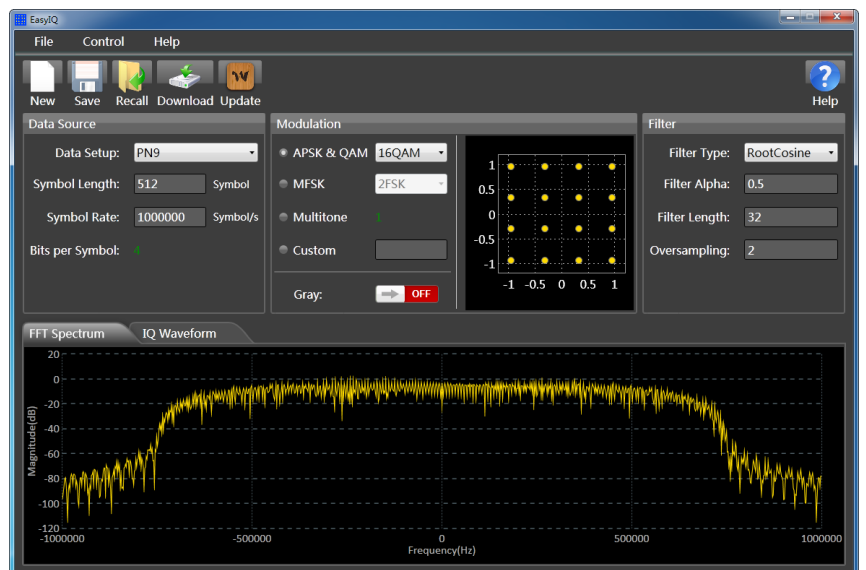

IQ waveforms can be generated by the PC software EasyIQ.

PRBS

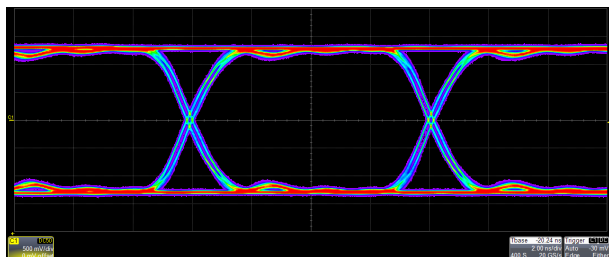

PRBS3 ~ PRBS32 with finely adjustable 10^6 bps ~ 300 Mbps bit rate and 1 ns ~ 1us edge.

***CH1:PRBS.ON.50Ω** **CH2:PRBS.ON.50Ω**

Bit Rate 122.880 000Mbps
 Amplitude 800.0mVpp
 Offset 850.0mVdc
 Length **PRBS-30**
 Rise/Fall 2.0ns

Load 50 Ω
 Output ON

TTL/CMOS LVTTTL/LVCOMS ECL LVPECL LVDS **Differential ON**

Preset common logic levels such as TTL, LVCMOS, LVPECL and LVDS. An added differential mode provides an easy way to generate differential signals using the both channels.

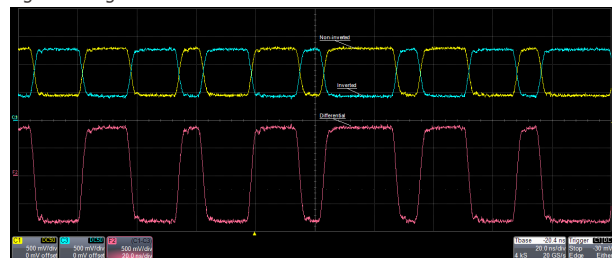

High Fidelity Output with 80dB Dynamic Range

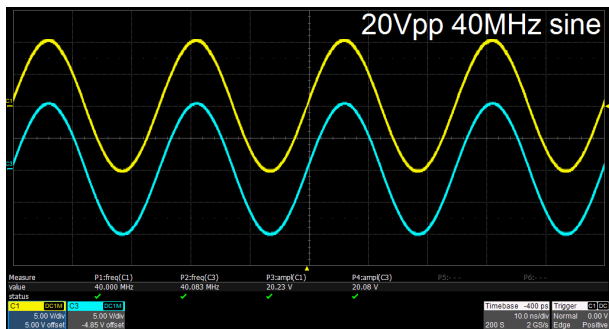

Large Signals at High Frequencies

Dual-channel, 20 Vpp amplitude sine wave guaranteed at up to 40 MHz.

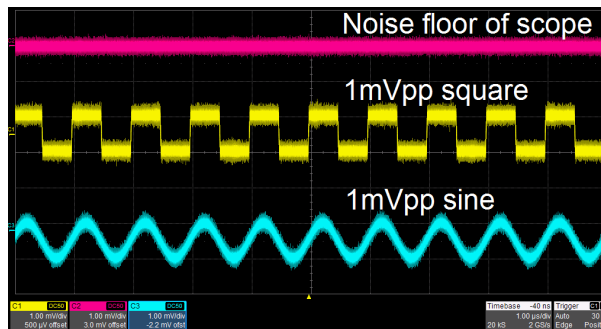

Small Signals

Low noise floor, improves signal-to-noise ratio.

Complex Signals Generation

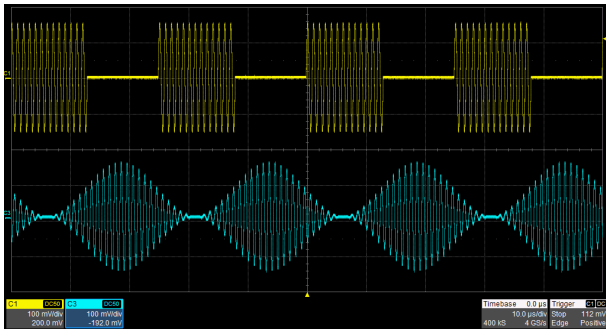

Modulation

Plenty of modulation types, such as AM, FM, PM, FSK, ASK, PSK, DSB-AM, PWM are supported. The modulation source can be configured as "Internal" or "External".

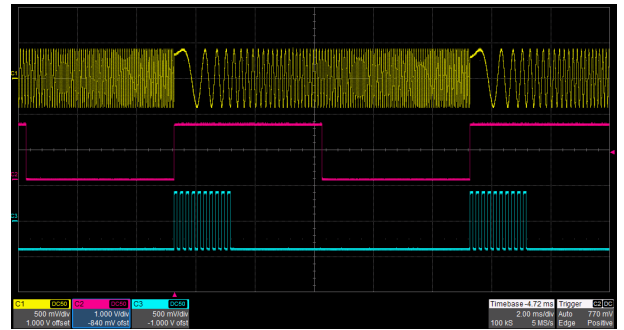

Sweep and Burst

Sweep modes include "Linear" and "Log". Burst modes includes "N cycle" and "Gated". Both Sweep and Burst can be triggered by "Internal", "External" or "Manual" source.

Waveform Combining

The waveform combining function superimposes CH1 and CH2 waveforms internally and provides the combined waveform to a user-selected output. Easily combine basic waveforms, random noise, modulation signals, sweep signals, burst signals, EasyPulse waveforms and TrueArb waveforms

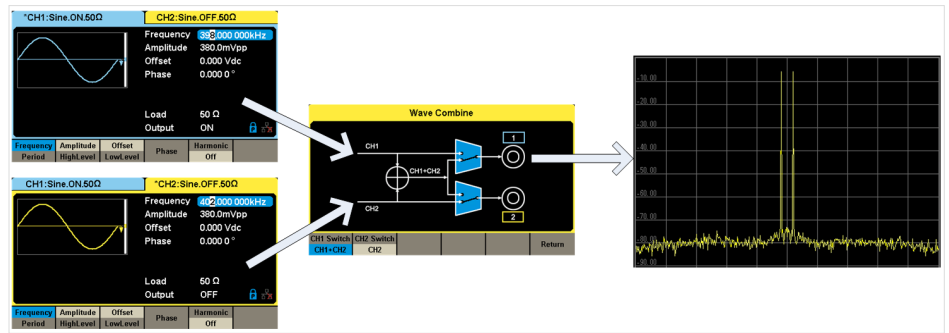

Harmonics Function

Harmonics function gives you the ability to add higher-order elements to your signal.

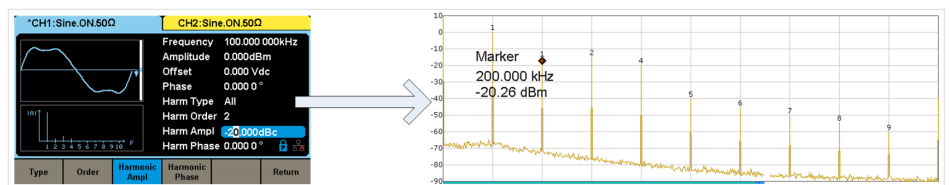

Two Dual-channel Operation Mode

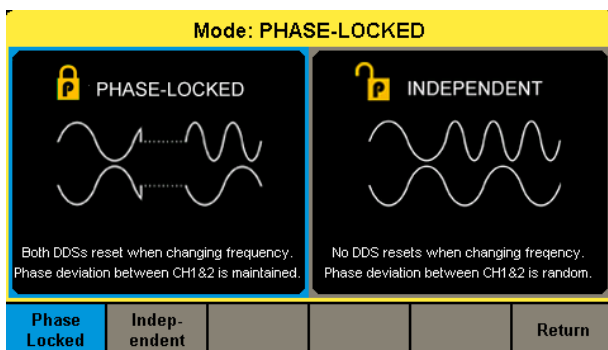

"Phase-Locked" mode automatically aligns the phases of each output. While "Independent" mode permit the two channels to be used as two independent generators. Independent mode also smoothes parameter (frequency, amplitude) changes made to an active channel.

Frequency Counter

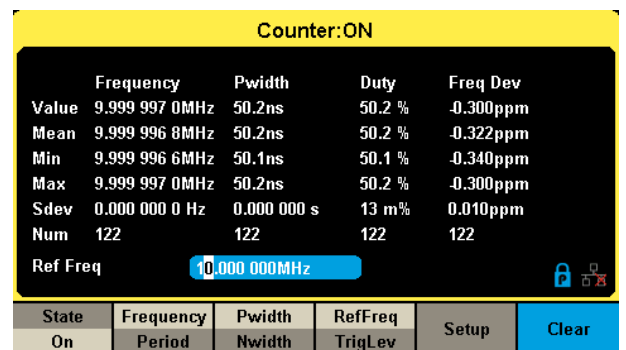

8-digit hardware frequency counter with statistics function and input range of 0.1 Hz ~ 400 MHz.

Specifications

All specifications apply to both channels. Unless otherwise stated, all specifications are not guaranteed unless the following conditions are met:

- The generator is within the valid calibration period
- The generator has been working continuously for at least 30 minutes at a specified temperature (18 °C ~ 28 °C)

Frequency					
Parameter	Min.	Typ.	Max.	Unit	Condition & Note
Resolution	1μ			Hz	
Initial accuracy	-1		+1	ppm	25°C
	-2		+2	ppm	0~40°C
1 st -year aging	-1		+1	ppm	25°C
10-year aging	-3.5		+3.5	ppm	25°C

Sine					
Parameter	Min.	Typ.	Max.	Unit	Condition & Note
Frequency	1μ		500M	Hz	SDG6052X
	1μ		350M	Hz	SDG6032X
	1μ		200M	Hz	SDG6022X
Harmonic distortion			-65	dBc	0 dBm, 0~1 MHz (included)
			-60	dBc	0 dBm, 1~60 MHz (included)
			-50	dBc	0 dBm, 60~100 MHz (included)
			-40	dBc	0 dBm, 100~200 MHz (included)
			-30	dBc	0 dBm, 200~300 MHz (included)
			-28	dBc	0 dBm, above 300 MHz
Total Harmonic Distortion			0.075	%	0 dBm, 10 Hz ~ 20 kHz
Non-harmonic spurious			-60	dBc	0 dBm, ≤350 MHz
			-55	dBc	0 dBm, >350 MHz
Output Range (Note)	2m		20	Vpp	≤ 40 MHz, HiZ load
	2m		10	Vpp	40 MHz ~ 120 MHz (included), HiZ load
	2m		5	Vpp	120 MHz ~ 160 MHz (included), HiZ load
	2m		3	Vpp	160 MHz ~ 350 MHz (included), HiZ load
	2m		1.28	Vpp	above 350MHz, HiZ load
Harmonics Order			10		
Type	Even, Odd, All				

Note : The specification will be divided by 2 while applied to a 50Ω load.

Pulse					
Parameter	Min.	Typ.	Max.	Unit	Condition & Note
Frequency	1 μ		150 M	Hz	SDG6052X, SDG6032X
	1 μ		80 M	Hz	SDG6022X
Pulse Width	3.3			ns	SDG6052X, SDG6032X
	3.4			ns	SDG6022X
Pulse width resolution	100			ps	
Pulse width accuracy			$\pm(0.01\%+0.3\text{ns})$		
Rise time (setting range)	1n			s	SDG6052X, SDG6032X 10% ~ 90%
	2n			s	SDG6022X 10% ~ 90%
Fall time (setting range)	1n			s	SDG6052X, SDG6032X 90% ~ 10%
	2n			s	SDG6022X 90% ~ 10%
Rise time (specified range)	2n			s	10% ~ 90%. Overshoot, jitter, output range and pulse width accuracy specifications are only guaranteed in specified rise/fall times range
Fall time (specified range)	2n			s	
Rise/fall times resolution	100			ps	
Overshoot			3	%	100 kHz, 1 Vpp, 50 Ω load , 2 ns edge
Duty cycle	0.001		99.999	%	Limited by frequency setting
Duty cycle resolution	0.001			%	
Jitter (rms) cycle to cycle			100	ps	1 Vpp, 50 Ω load
Output Range (Note)	2m		20	Vpp	\leq 20 MHz, HiZ load , 2ns edge , \geq 10 ns width
	2m		10	Vpp	20 MHz ~ 120 MHz (included) , HiZ load , 2ns edge , \geq 10 ns width
	2m		5	Vpp	Above 120 MHz , HiZ load , 2ns edge , \geq 10 ns width

Note : The specification will be divided by 2 while applied to a 50 Ω load.

Square					
Parameter	Min.	Typ.	Max.	Unit	Condition & Note
Frequency	1 μ		120M	Hz	SDG6052X, SDG6032X
	1 μ		80M	Hz	SDG6022X
Rise /fall times		2	2.4	ns	10% ~ 90%, 1 Vpp, 50 Ω load
Overshoot			3	%	100 kHz, 1 Vpp, 50 Ω load
Duty cycle	10		90	%	Limited by frequency setting
Jitter (rms) cycle to cycle			100	ps	1 Vpp, 50 Ω load
Output Range (Note)	2m		20	Vpp	\leq 20 MHz, HiZ load
	2m		10	Vpp	Above 20 MHz , HiZ load

Note : The specification will be divided by 2 while applied to a 50 Ω load.

Ramp					
Parameter	Min.	Typ.	Max.	Unit	Condition & Note
Frequency	1 μ		5M	Hz	
Symmetry	0		100	%	
Linearity			1	%	Percentage of peak output, 1 kHz, 1 Vpp, 50% symmetry
Output Range (Note)	2m		20	Vpp	

Note : The specification will be divided by 2 while applied to a 50 Ω load.

Noise

Parameter	Min.	Typ.	Max.	Unit	Condition & Note
Bandwidth (-3dB)		500		MHz	SDG6052X
		350		MHz	SDG6032X
		200		MHz	SDG6022X
Bandwidth setting range	1m		BW	Hz	BW is the max. frequency
Output Range (Note)	2m		1.084	Vrms	Mean = 0 Bandwidth limit = OFF

Note : The specification will be divided by 2 while applied to a 50Ω load.

Arbitrary Wave

Parameter	Min.	Typ.	Max.	Unit	Condition & Note
Frequency setting range	1μ		50M	Hz	
Waveform length	2		20M	pts	
Sampling rate	1u		300M	Sa/s	TrueArb mode
		1.2G		Sa/s	DDS mode
Vertical resolution		16		bit	
Rise/fall times		2.6		ns	10% ~ 90%, 1Vpp step signal , DDS mode
Jitter (rms) cycle to cycle			100	ps	1 Vpp, 50Ω load , TrueArb mode
Output Range (Note)	2m		20	Vpp	≤ 20 MHz, HiZ load
	2m		10	Vpp	Above 20 MHz , HiZ load

Note : The specification will be divided by 2 while applied to a 50Ω load.

DC

Parameter	Min.	Typ.	Max.	Unit	Condition & Note
Output Range	-10		10	V	HiZ load
	-5		5	V	50Ω load
Accuracy			±(1%+2mV)		HiZ load

IQ (optional)

Parameter	Min.	Typ.	Max.	Unit	Condition & Note
Symbol rate	250		37.5M	Symb/s	Limited by the oversampling factor
Vertical resolution		16		bit	
Modulation type	2ASK, 4ASK, 8ASK, BPSK, QPSK, 8PSK, DBPSK, DQPSK, D8PSK, 8QAM, 16QAM, 32QAM, 64QAM, 128QAM, 256QAM, 2FSK, 4FSK, 8FSK, 16FSK, MSK, MultiTone, custom				Supported by EasyIQ software
Pattern	PN7, PN9, PN15, PN23, User file, Custom				Supported by EasyIQ software
Output Range	1m		0.5	Vrms	$\sqrt{I^2 + Q^2}$, 50Ω load
Carrier frequency			500M	Hz	SDG6052X
			350M	Hz	SDG6032X
			200M	Hz	SDG6022X

PRBS					
Parameter	Min.	Typ.	Max.	Unit	Condition & Note
Bit rate	1u		300M	bps	SDG6052X, SDG6032X
	1u		160M	bps	SDG6022X
Sequence length	2^{m-1} , m = 3, 4, ... , 32				
Rise/fall times	1n		1u	s	SDG6052X, SDG6032X. 10% ~ 90%, 1 Vpp, 50Ω load
	2n		1u	s	SDG6022X. 10% ~ 90%, 1 Vpp, 50Ω load
Output Range (Note)	2m		20	Vpp	≤ 40 Mbps, HiZ load ,
	2m		10	Vpp	40 ~ 240 Mbps (included), HiZ load
	2m		5	Vpp	Above 240 Mbps , HiZ load

Note : The specification will be divided by 2 while applied to a 50Ω load.

Output					
Parameter	Min.	Typ.	Max.	Unit	Condition & Note
Accuracy	±(1%+1mVpp)				10 kHz sine, 0 V offset
Amplitude flatness	-0.3		+0.3	dB	50Ω load, 0.5 Vpp, compare to 1MHz Sine
Output impedance	49.5	50	50.5	Ω	100 kHz sine
Output current	-200		200	mA	
Crosstalk			-60	dBc	CH1=CH2=0 dBm, Sine, 50 Ω load
Protection	Current limiting, Over voltage protection				
Current-limit threshold		±200		mA	
Over voltage protection threshold	±3.5	±4	±4.5	V	The amplitude of the generator <3.2Vpp and the DC offset < 2VDC
	±10.5	±11	±11.5	V	The amplitude of the generator ≥3.2Vpp or the DC offset ≥ 2VDC

Modulation					
AM					
Parameter	Min.	Typ.	Max.	Unit	Condition & Note
Carrier	Sine, Square, Ramp, Arb				
Modulation source	Internal/External				
Modulation wave	Sine, Square, Ramp, Noise, Arb				
Modulation depth	0		120	%	
Modulation frequency	1m		1M	Hz	While modulation source is "Internal"
FM					
Parameter	Min.	Typ.	Max.	Unit	Condition & Note
Carrier	Sine, Square, Ramp, Arb				
Modulation source	Internal/External				
Modulation wave	Sine, Square, Ramp, Noise, Arb				
Frequency deviation	0		0.5*BW		BW is the max. frequency. Limited by frequency setting
Modulation frequency	1m		1M	Hz	While modulation source is "Internal"
PM					
Parameter	Min.	Typ.	Max.	Unit	Condition & Note
Carrier	Sine, Square, Ramp, Arb				
Modulation source	Internal/External				
Modulation wave	Sine, Square, Ramp, Noise, Arb				
Phase deviation	0		360	°	
Modulation frequency	1m		1M	Hz	While modulation source is "Internal"

ASK					
Parameter	Min.	Typ.	Max.	Unit	Condition & Note
Carrier	Sine, Square, Ramp, Arb				
Modulation source	Internal/External				
Modulation wave	Square with 50% duty cycle				
Keying frequency	1m		1M	Hz	While modulation source is "Internal"
FSK					
Parameter	Min.	Typ.	Max.	Unit	Condition & Note
Carrier	Sine, Square, Ramp, Arb				
Modulation source	Internal/External				
Modulation wave	Square with 50% duty cycle				
Keying frequency	1m		1M	Hz	While modulation source is "Internal"
PSK					
Parameter	Min.	Typ.	Max.	Unit	Condition & Note
Carrier	Sine, Square, Ramp, Arb				
Modulation source	Internal/External				
Modulation wave	Square with 50% duty cycle				
Keying frequency	1m		1M	Hz	While modulation source is "Internal"
PWM					
Parameter	Min.	Typ.	Max.	Unit	Condition & Note
Carrier	Pulse				
Modulation source	Internal/External				
Modulation wave	Sine, Square, Ramp, Noise, Arb				
Modulation frequency	1m		1M	Hz	While modulation source is "Internal"

Burst					
Parameter	Min.	Typ.	Max.	Unit	Condition & Note
Carrier	Sine, Square, Ramp, Pulse, Noise, Arb				
Type	Count (1-1000000 periods), Infinite, Gated				
Carrier frequency	2m		BW	Hz	BW is the max. output frequency
Start/Stop phase	0		360	°	
Internal period	1μ		1000	s	
Trigger source	Internal, External, Manual				
Gated source	Internal/External				
Trigger delay			100	s	

Sweep					
Parameter	Min.	Typ.	Max.	Unit	Condition & Note
Carrier	Sine, Square, Ramp, Arb				
Type	Linear, Logarithmic				
Direction	Linear: Up, Down, Up & Down Logarithmic: Up, Down				
Carrier frequency	1μ		BW	Hz	BW is the max. output frequency
Sweep time	1m		500	s	
Trigger source	Internal, External, Manual				

Frequency Counter					
Parameter	Min.	Typ.	Max.	Unit	Condition & Note
Function	Frequency, Period, Positive/Negative Pulse Width, Duty Cycle				
Coupling mode	AC, DC, HF REJ				
Frequency range	100m		400M	Hz	DC coupling
Input amplitude	1		400M	Hz	AC coupling
	100mVrms		±2.5V		DC coupling , < 100 MHz
	200mVrms		±2.5V		DC coupling , 100 MHz ~ 200MHz
	500mVrms		±2.5V		DC coupling , Above 200 MHz
	100mVrms		5 Vpp		AC coupling , < 100 MHz
	200mVrms		5 Vpp		AC coupling , 100 MHz ~ 200MHz
	500mVrms		5 Vpp		AC coupling , Above 200 MHz
Input impedance		1M		Ω	

Reference Clock					
10MHz Input					
Parameter	Min.	Typ.	Max.	Unit	Condition & Note
Frequency	9.999M	10M	10.001M	Hz	
Amplitude	1.4			Vpp	
Input impedance	5			kΩ	AC coupling
10MHz Output					
Parameter	Min.	Typ.	Max.	Unit	Condition & Note
Frequency		10M		Hz	Synchronized to internal reference clock
Amplitude	2	3.3		Vpp	HiZ load
Output impedance		50		Ω	

Auxiliary In/Out					
Trigger Input					
Parameter	Min.	Typ.	Max.	Unit	Condition & Note
V _{IH}	2		5.5	V	
V _{IL}	-0.5		0.8	V	
Input impedance	100			kΩ	
Pulse width	100			ns	
Response time			100	ns	Sweep
			600	ns	Burst
Trigger Output					
Parameter	Min.	Typ.	Max.	Unit	Condition & Note
V _{OH}	3.8			V	I _{OH} = -8 mA
V _{OL}			0.44	V	I _{OL} = 8 mA
Output impedance		100		Ω	
Frequency			1	MHz	

Sync Out					
Parameter	Min.	Typ.	Max.	Unit	Condition & Note
V _{OH}	3.8			V	I _{OH} = -8 mA
V _{OL}			0.44	V	I _{OL} = 8 mA
Output impedance		100		Ω	
Pulse width		26.7		ns	
Jitter		3.3		ns	Peak to peak
Frequency			10	MHz	
Modulation Input					
Parameter	Min.	Typ.	Max.	Unit	Condition & Note
Frequency	0		50	kHz	
Input impedance	10			kΩ	
Amplitude @100% modulation depth	11	12	13	V _{pp}	

General					
Power					
Parameter	Min	Typ	Max	Unit	Condition
Voltage	100 - 240 Vrms (± 10%), 50 / 60 Hz 100 - 120 Vrms (± 10%), 400 Hz				
Power consumption		32.5	50	W	Dual channels, Sine, 1kHz, 10Vpp, 50Ω load
Display					
Parameter	Min.	Typ.	Max.	Unit	Condition & Note
Color depth		24		bit	
Contrast Ratio		350:1			
Luminance		300		cd/m ²	
Touch Screen Type	Resistive				
Environment					
Parameter	Min.	Typ.	Max.	Unit	Condition & Note
Operating temperature	0		40	°C	
Storage temperature	-20		60	°C	
Operating humidity	5		90	%	≤ 30 °C
	5		50	%	40 °C
Non -operating humidity	5		95	%	
Operating altitude			3048	m	≤ 30 °C
Non -operating altitude			15000	m	
Calibration					
Parameter	Min.	Typ.	Max.	Unit	Condition & Note
Calibration interval		1		year	
Mechanical					
Parameter	Min.	Typ.	Max.	Unit	Condition & Note
Dimensions	W×H×D = 260.3mm×107.2mm×295.7mm				
Net weight		3.5		kg	
Gross weight		4.6		kg	
Compliance					
LVD	IEC 61010-1:2010				
EMC	EN61326-1:2013				

Ordering Information

Product Description	
SDG6052X	500 MHz, 2-CH, 2.4 GSa/s, 16-bit
SDG6032X	350 MHz, 2-CH, 2.4 GSa/s, 16-bit
SDG6022X	200 MHz, 2-CH, 2.4 GSa/s, 16-bit
Standard Configurations	
Quick start ×1	
Power cord ×1	
Calibration certificate ×1	
USB cable ×1	
BNC coaxial cable x2	
Optional Configurations	
SPA1010	10W Power Amplifier
ATT-20dB	20 dB Attenuator
USB-GPIB	USB-GPIB Adapter
SDG-RMK	Single Instrument Rack Mount Kit
SDG-6000X-IQ	IQ Signal Generator Function

SDG6000X

Series

Pulse/Arbitrary
Waveform Generator



About SIGLENT

SIGLENT is an international high-tech company, concentrating on R&D, sales, production and services of electronic test & measurement instruments.

SIGLENT first began developing digital oscilloscopes independently in 2002. After more than a decade of continuous development, SIGLENT has extended its product line to include digital oscilloscopes, function/arbitrary waveform generators, digital multimeters, DC power supplies, spectrum analyzers, isolated handheld oscilloscopes and other general purpose test instrumentation. Since its first oscilloscope, the ADS7000 series, was launched in 2005, SIGLENT has become the fastest growing manufacturer of digital oscilloscopes. We firmly believe that today SIGLENT is the best value in electronic test & measurement.

Headquarter:

SIGLENT TECHNOLOGIES CO., LTD.
Add: Bldg No.4 & No.5, Antongda Industrial
Zone, 3rd Liuxian Road, Bao'an District,
Shenzhen, 518101, China.
Tel: + 86 755 3661 5186
Fax: + 86 755 3359 1582
Email: sales@siglent.com;
Website: <http://www.siglent.com/ens/>

USA:

SIGLENT Technologies America, Inc
6557 Cochran Rd Solon, Ohio 44139
Tel: 440-398-5800
Toll Free: 877-515-5551
Fax: 440-399-1211
Email: info@siglent.com
Website: www.siglentamerica.com

Europe:

SIGLENT TECHNOLOGIES EUROPE GmbH
ADD: Liebigstrasse 2-20, Gebaeude 14,
22113 Hamburg Germany
Tel: +49(0)-819-95946
Fax: +49(0)-819-95947
Email: info-eu@siglent.com
Website: www.siglenteu.com

Follow us on
Facebook: SiglentTech

