

SPS5000X Series Wide Range Programmable Switching DC Power Supply



Quick Start

EN02B



SIGLENT TECHNOLOGIES CO.,LTD

Copyright Information

Declaration

SIGLENT products are protected by patent law in and outside of P.R.C.

SIGLENT reserves the right to modify or change parts of or all the specifications or pricing policies at the company's sole decision.

Information in this publication replaces all previously corresponding material.

Any method of copying, extracting, or translating the contents of this manual is not allowed without the permission of **SIGLENT**.

Note: **SIGLENT** is the registered trademark of SIGLENT TECHNOLOGIES CO., LTD.

Contents

Copyright Information	1
General Safety Summary	3
Safety Terms and Symbols	4
Allgemeine Sicherheitsübersicht.....	5
Sicherheitsbegriffe und -symbole	7
General Inspection	8
Preparation Before Use	9
Quick Start.....	10
Panel Introduction.....	11
User Interface	15
Basic Operations	18
Remote	22
Troubleshooting.....	23
More Information	24

General Safety Summary

Understand the following safety precautions to avoid personal injury and prevent damage to this product or any other products connected to it. In order to avoid possible dangers, please use this product in accordance with regulations.

Only qualified technicians can perform maintenance procedures.

Prevent fire or personal injury.

Use proper power cord

Only use the power cord for this product approved by your country.

Ground the product

This product is grounded through the grounding conductor of the power cord. In order to prevent electric shock, the grounding conductor must be connected to the earth. Before connecting to the input or output terminal of this product, be sure to properly ground the product.

Connect the output cable correctly

Do not connect the ground wire to high voltage. During the test, do not touch the exposed contacts and components.

View the ratings of all terminals

To prevent the risk of fire or electric shock, please check all ratings and marking instructions for this product. Before connecting the product, please read this product manual for further information about the ratings.

Do not operate when you suspect that the product is malfunctioning

If you suspect that this product is damaged, please have it inspected by qualified maintenance personnel.

Avoid exposed circuits

Do not touch the exposed connectors and components after the power is turned on.

Do not operate in a humid environment.

Do not operate in a flammable and explosive environment.

Keep the product surface clean and dry

Safety Terms and Symbols

Terms used in this product. These terms may appear in the product:

- DANGER** Indicates direct injury or hazards that may happen.
- WARNING** Indicates potential injury or hazards that may happen.
- CAUTION** Indicates potential damage to the instrument or other property that may happen.

Symbols used in this product. These symbols may appear on the product:



Hazardous
Voltage



Warning



Protective
Earth Ground



Earth Ground



Power Switch

Allgemeine Sicherheitsübersicht

Lesen Sie die folgenden Sicherheitshinweise sorgfältig durch, um Verletzungen oder Schäden am Gerät und an den daran angeschlossenen Produkten zu vermeiden. Um mögliche Gefahren zu vermeiden, verwenden Sie das Gerät bitte wie angegeben.

Verwenden Sie ein geeignetes Netzkabel

Verwenden Sie nur das für das Gerät vorgesehene und im jeweiligen Land zugelassene Netzkabel.

Erden Sie das Gerät

Das Gerät ist über den Schutzleiter der Netzleitung geerdet. Um einen elektrischen Schlag zu vermeiden, vergewissern Sie sich bitte, dass das Gerät korrekt geerdet ist, bevor Sie die Eingangs- oder Ausgangsklemmen des Geräts anschließen.

Schließen Sie das Messkabel richtig an

Die Kabelschirmung (Masse) des Messkabels ist gleich dem Potential der Erde, schließen Sie das Messkabel also nicht an eine hohe Spannung an.

Überprüfen Sie die Nennwerte aller Klemmen

Um Feuer oder einen elektrischen Schlag zu vermeiden, beachten Sie bitte alle Angaben und Hinweise auf dem Gerät. Bevor Sie das Gerät anschließen, lesen Sie bitte das Handbuch sorgfältig durch, um weitere Informationen über die Nennwerte zu erhalten.

Verwenden Sie einen ordnungsgemäßen Überspannungsschutz

Stellen Sie sicher, dass keine Überspannung (z. B. durch ein Gewitter) an das Gerät gelangen kann, da sonst die Gefahr eines elektrischen Schlages besteht.

Schutz vor Elektrostatik

Betreiben Sie das Gerät in einer Umgebung, die vor elektrostatischer Entladung geschützt ist, um Schäden durch statische Entladung zu vermeiden. Erden Sie vor dem Anschließen immer sowohl den Innen- als auch den Außenleiter des Kabels, um statische Aufladung abzubauen.

Für gute Belüftung sorgen

Eine unzureichende Belüftung kann zu einem Temperaturanstieg führen, der schließlich das Gerät beschädigt. Sorgen Sie daher für eine gute Belüftung und überprüfen Sie regelmäßig die Ansaugung und den Lüfter.

Vermeiden Sie freiliegende Schaltkreise oder Komponenten

Berühren Sie keine freiliegenden Kontakte oder Bauteile, wenn das Gerät eingeschaltet ist.

Richtige Sicherung verwenden

Verwenden Sie nur die angegebene Sicherung.

Betreiben Sie das Gerät nicht ohne Abdeckungen

Betreiben Sie das Gerät nicht, wenn Abdeckungen oder Verkleidungen entfernt sind.

Betreiben Sie das Gerät nicht bei vermuteten Defekten

Wenn Sie vermuten, dass das Gerät beschädigt ist, lassen Sie es vor dem weiteren Betrieb von qualifiziertem Servicepersonal überprüfen. Jegliche Wartung, Einstellung oder Austausch, insbesondere von Schaltkreisen oder Zubehör, muss von SIGLENT autorisiertem Personal durchgeführt werden.

Nicht in feuchter Umgebung betreiben

Um einen Kurzschluss im Geräteinneren oder einen elektrischen Schlag zu vermeiden, betreiben Sie das Gerät nicht in feuchter Umgebung.

Betreiben Sie das Gerät nicht in explosionsgefährdeten Umgebungen

Um Schäden am Gerät oder Personenschäden zu vermeiden, ist es wichtig, das Gerät nicht in explosionsgefährdeter Umgebung zu betreiben.

Halten Sie die Produktoberflächen sauber und trocken

Um den Einfluss von Staub und/oder Feuchtigkeit in der Luft zu vermeiden, halten Sie die Oberfläche des Geräts bitte sauber und trocken.

Sicherheit bei der Handhabung

Bitte behandeln Sie das Gerät während des Transports vorsichtig, um Schäden an Tasten, Drehknopfschnittstellen und anderen Teilen auf den Bedienfeldern zu vermeiden.

Es dürfen nur Tastköpfe verwendet werden, die den Spezifikationen des Herstellers entsprechen

Bei Verwendung von 2X/.../10000X-Sondenbaugruppen müssen die Sondenbaugruppen durch eine doppelte oder verstärkte Isolierung von den gemessenen Stromkreisen isoliert sein.

Alle Sondenbaugruppen sollten die Anforderungen von UL 61010-031 und CAN/CSA-C22.2 Nr. 61010-031-07 erfüllen.

Das Gerät darf nicht so positioniert werden, dass es schwierig ist, die Trennvorrichtung (abnehmbarer Stecker) zu bedienen.

Wenn das Gerät auf eine Weise verwendet wird, die nicht vom Hersteller angegeben ist, kann der Schutz, den das Gerät bietet, beeinträchtigt werden.

Sicherheitsbegriffe und symbole

Begriffe in diesem Handbuch. Diese Begriffe können in diesem Handbuch vorkommen:



WARNUNG

Warnhinweise weisen auf Bedingungen oder Praktiken hin, die zu Verletzungen oder zum Verlust des Lebens führen können.



VORSICHT

Vorsichtshinweise weisen auf Bedingungen oder Praktiken hin, die zu Schäden an diesem Produkt oder anderen Gegenständen führen können.

Begriffe auf dem Produkt. Diese Begriffe können auf dem Produkt erscheinen:

GEFAHR Weist auf direkte Verletzungen oder Gefahren hin, die auftreten können.

WARNUNG Weist auf mögliche Verletzungen oder Gefährdungen hin, die auftreten können.

VORSICHT Weist auf mögliche Schäden am Gerät oder an anderen Gegenständen hin, die eintreten können.

Symbole auf dem Produkt. Diese Symbole können auf dem Produkt erscheinen:



Hazardous
Voltage



Protective
Earth



Warning



Terminal
Ground



Power Switch

Wenn Sie solche Symbole auf dem Produkt finden, ziehen Sie das Handbuch zu Rate, um die Art der potenziellen Gefahr und die zu ergreifenden Maßnahmen zu erfahren

General Inspection

- **Inspect the shipping container**

Keep the original shipping container and cushioning material until the contents of the shipment have been completely checked and the instrument has passed both electrical and mechanical tests.

The consigner or carrier will be responsible for damages to the instrument resulting from shipment.

SIGLENT will not provide free maintenance or replacement if the instrument has been damaged in shipment.

- **Inspect the instrument**

If there are instruments found damaged, defective, or have failed any electrical and / or mechanical tests, please contact SIGLENT.

- **Check the accessories**

Please check the accessories according to the packing list. If the accessories are incomplete or damaged, please contact your SIGLENT sales representative.

Preparation Before Use

Connect AC power

According to the machine you get, please use the power cord provided in the accessories to connect to the power source as follows.



Figure 1 Type I

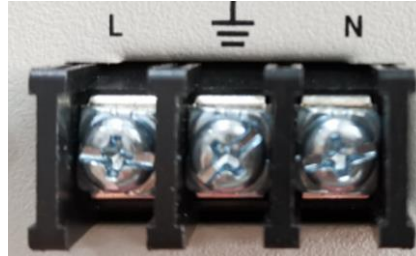

Figure 2 Type II

Connection method

- Type I /10A: applicable models 360W and 720W

The specification of the equipment that can input AC power is: 100~240V, 47~63Hz.

Use the power cord provided in the accessories to directly plug into the power interface.

- Type II /16A: applicable models 1080W

The specification of the equipment that can input AC power is: 100~240V, 47~63Hz. The power cord connection method provided by the accessories:

Black/Brown: live wire, connect to L port

White/Blue: neutral line, connected to port N

Green/Green-yellow: ground wire, connected to GND port



American Standard



European standard

Figure 3 II Wiring diagram

Quick Start

Technical specifications

For detailed technical specifications, please refer to the data sheet of SIGLENT's official website (www.siglent.com)

The main parameters	
Number of output channels	1/2/3
Output voltage	40V/50V/80V/160V
Output current	7.5A/10A/15A/22.5A/30A/45A/60A/90A
Output power	180W/360W/720W/1080W
Power ratio	3.33

Standard accessories:

- ✓ One SPS power supply
- ✓ An international AC power cord
- ✓ A quick start manual
- ✓ Output terminal cover

The SPS5000X series includes 16 models, with 4 voltage output types: 40V/50V/80V/160V, with up to three output channels:

Model	Type	Channel number (/CH)	Rated voltage (V)	Rated current (A)	power(W)
SPS5041X	I	1	0~40	0~30	360
SPS5042X	II	1	0~40	0~60	720
SPS5043X	III	1	0~40	0~90	1080
SPS5044X	IV	2	0~40/CH	0~30/CH	360/CH
SPS5045X	V	3	0~40/CH	0~30/CH	360/CH
SPS5051X	I	1	0~50	0~10	180
SPS5081X	I	1	0~80	0~15	360
SPS5082X	II	1	0~80	0~30	720
SPS5083X	III	1	0~80	0~45	1080
SPS5084X	IV	2	0~80/CH	0~15/CH	360/CH
SPS5085X	V	3	0~80/CH	0~15/CH	360/CH
SPS5161X	I	1	0~160	0~7.5	360
SPS5162X	II	1	0~160	0~15	720
SPS5163X	III	1	0~160	0~22.5	1080
SPS5164X	IV	2	0~160/CH	0~7.5/CH	360/CH
SPS5165X	V	3	0~160/CH	0~7.5/CH	360/CH

Panel Introduction

Front Panel

Type III/Type V :



Type I :



Type II /Type IV :









- A. Screen
- B. Button
- C. Knob
- D. USB Host port

- E. Panel
- F. Power switch
- G. Stand
- H. Front output port

Screen

Equipped with a 2.4-inch OLED display for displaying system output status, system parameter settings, menu options, and promotion information.

Button

	Used to view system information and configure power parameters.
	In the main interface, press this key to select and set the output voltage value or output current value. Press this key in the function area to enter the next menu, which is equivalent to the confirm key.
	Press Menu to enter the menu list, press this key to return to the previous menu. When the power supply enters the protection state, long press the key to release the protection mode
	Press this key to enter the List mode, you can set each group of output current, output voltage and running time, etc. Press this key again to exit the List interface
	Press this key to turn on the keyboard lock function, long press to release the key lock.
	Used to recall or store the state. If you select List, press this key to store or recall the List state.
	The direction buttons are used to switch the digits of the value where the cursor is selected, and to move the cursor position or switch options.

Direction knob

When setting parameters, turn the knob to increase or decrease the value at the cursor.

When setting objects (voltage or current, operation mode, internal resistance configuration, etc.), rotate the knob to quickly move the cursor position or switch options, press the knob to set the current parameters, rotate the knob to increase or decrease the value at the cursor, and press again to make the current setting effective.

USB A port

Used to insert peripheral USB devices for file transfer and system upgrades.

Power Switch

Used to turn the power on or off.

Front output port (positive (+), negative (-))

40V and 50V models have the current output front port, which can output a maximum of 10A current.

Note:

The front and rear outputs cannot be used at the same time. When the front output is connected to the load, the rear port should not be connected to the load.

Back Panel

Type V

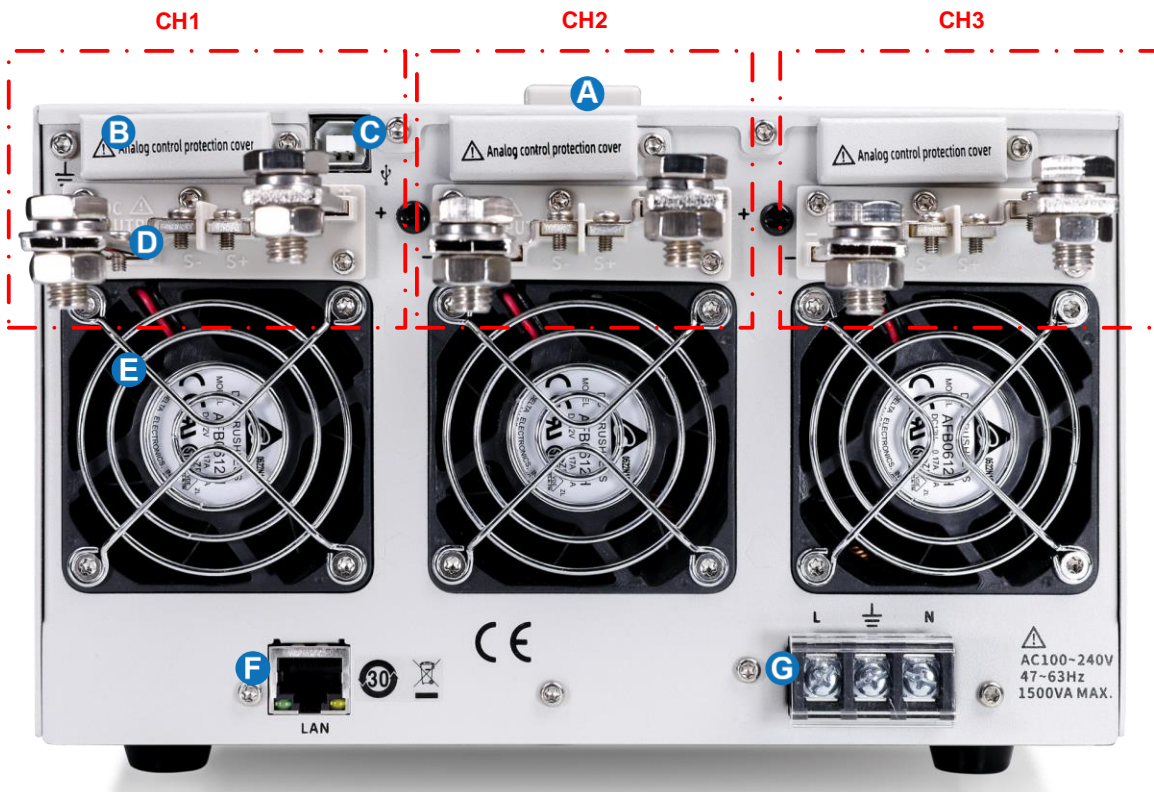

Type I



Type II



- A. Handle
- B. Analog connector port
- C. USB Device port
- D. Output interface

- E. Fan port
- F. LAN port
- G. AC power interface

Analog connector port

Used to detect the output of voltage and current, and also used for analog control of current and voltage output.

USB Device port

This interface can be connected to a PC to realize USBTMC communication, and control the power supply by sending commands through the upper computer software.

Output Interface

One set of positive (+) and negative (-) output terminals, type IV has two output ports, and type V has three output ports. With multiple output channels, face up to the power supply from right to left, the one near the display is CH1, then CH2, CH3.

Fan port

The temperature-controlled fan can effectively dissipate the heat of the power supply line.

LAN port

Used to connect the power supply to the computer or the network where the computer is located. SPS5000X conforms to the VXI-11 instrument standard, and supports Socket-based and remote commands, and remote control using WEB. It can quickly build a test system with other standard equipment and easily achieve system integration.

AC power interface

The AC power supply supports 100 ~ 240V, 47Hz ~ 63Hz. Please use the power cord provided in the attachment to connect to AC power supply. For different types of power interface connection, please refer to [7.1].

User Interface

The SPS5000X series has three different user interfaces according to different output channels:

Type I /Type II /Type III :

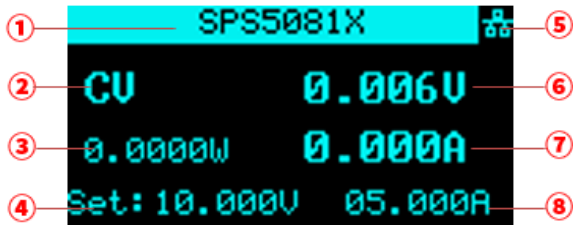

Type V :

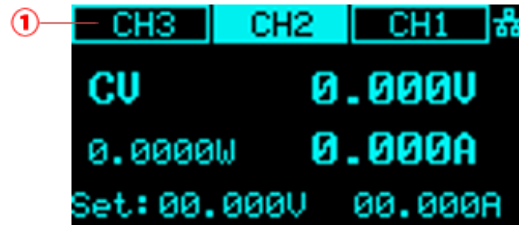

- ① For single-channel models, the status bar here displays the machine model information, if it is multi-channel, the status of each channel is displayed here.

Channel status can be configured, operation method:

Menu → **Configure** → **Channel Mode** . When set to Off, the status is displayed as **✕CH2** . At this time, the output of the channel is closed, and the voltage and current cannot be output normally.

- ② Display the working mode of the power supply.
- ③ The output power value of the power supply.
- ④ The setting value of the voltage, you can set the size of the output voltage value, the method: Press the **Set** key to switch the cursor position, press the left and right direction keys to switch the cursor to the number of digits, turn the knob to increase or decrease the value, press the knob to confirm.
- ⑤ Display the status of LAN network port or peripheral USB access. When the network cable is connected or the U disk is inserted, the highlight here **U** Indicates that a U disk has been read, **E** Indicates that the LAN cable is connected
- ⑥ The output voltage value of the power supply.
- ⑦ The output current value of the power supply
- ⑧ The setting value of the current, you can set the size of the output current value, Operation method: Press the Set key to switch the cursor position, press the left and right direction keys to switch the cursor to the number digits, turn the knob to increase or decrease the value, press the knob to confirm.

List interface:

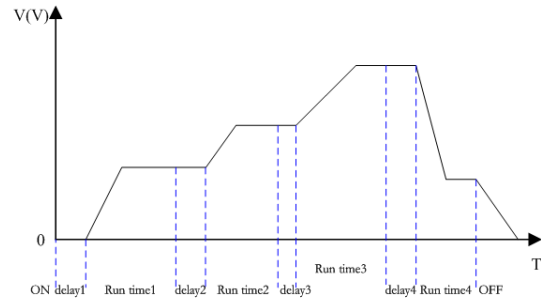
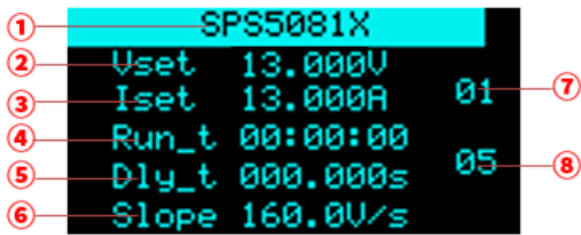

- ① For single-channel models, the status bar displays the machine model; for multi-channel models, the current channel is displayed here. You can press the left and right direction keys to select.
- ② Set the voltage to be output. After pressing the knob, move the cursor to here, and select the knob to change the value.
- ③ Set the size of the current to be output, press the knob and move the cursor to here, select the knob to change the value.
- ④ Run time.
- ⑤ Delay time of current step.
- ⑥ Slope. The same rising and falling slope of the current step.
- ⑦ Number of List groups in the current setting interface, 01 means the first group.
 Setting method: In the List setting interface, press the key when the cursor is hidden to switch the current group number interface.
- ⑧ Total number of steps, the total number of steps output by List, 05 means there are 5 sets of data.
 Setting method: In the List setting interface, move the cursor to here, turn the knob to change the value, and press the knob to confirm the setting is successful.

3.1.1.8 and updated version list introduction

Press the List key on the front panel to enter the list main interface, as shown in the following figure

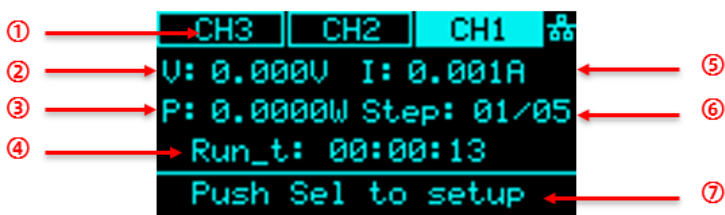

- ① Channel display: press the left and right direction keys on the front panel to switch channels. For single channel models, the model information is displayed here.
- ② Displays the real-time voltage at the list status output.
- ③ Displays the real-time power output by the list.
- ④ Running time: displays the remaining time of the current steps. The time countdown is performed in the form of hour: minute: second when outputting.
- ⑤ Displays the real-time current at the output of the list.
- ⑥ Display of running steps. It is expressed in the form of current running steps / total steps.
- ⑦ Operation prompt. Press the knob in this interface to enter the list parameter configuration interface.

Enter the list parameter configuration interface, rotate the knob to select parameters. Press the knob at the point where the * sign points to set this parameter. After setting, press the knob again to take effect.

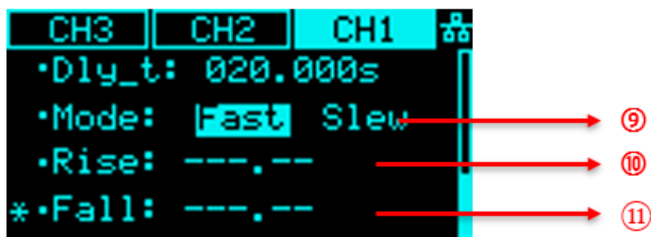
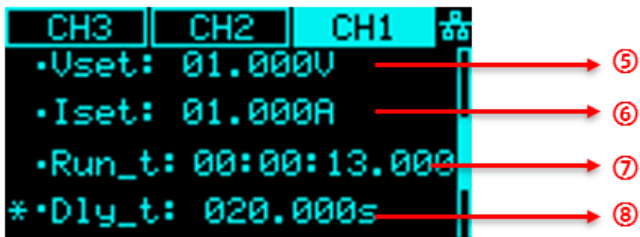
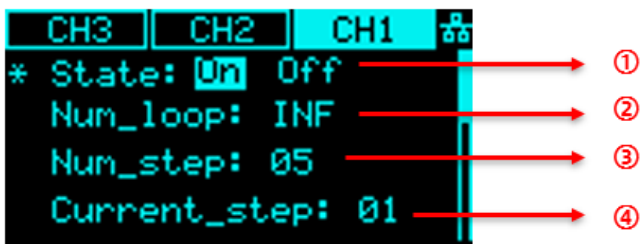







- ① List output enable status. It is used to realize the independent control of the list output of each channel by the multi-channel model. This setting is not available for single channel models.
- ② Number of cycles. Set the number of output cycles for the total number of steps, and INF is infinite cycle.
- ③ Total steps.
- ④ The number of steps of the current operation. 01 represents the first step.
- ⑤ Set the output voltage value for the current number of steps.
- ⑥ Set the output current value for the current number of steps.
- ⑦ The running time is expressed in the form of hour: minute: second.
- ⑧ Set the output delay time of the current number of steps.
- ⑨ The output priority mode of the current number of steps is fast priority by default.

When Slew is selected, ⑩ rising slope and ⑪ falling slope can be set

Basic Operations

View system information

Users can view the system information through Menu -> System -> Version, and the contents to be viewed include:

-  Boot times
-  Supplier name
-  Product model
-  Specifications
-  Serial number
-  Software version
-  Hardware version



Upgrade

Please follow the steps below to upgrade:



1. Download the upgrade package from the official website.
2. Copy the .ADS file in the upgrade package to the root directory of the U disk.
3. Insert the U disk into the USB port, press **Menu** -> **System** -> **Upgrade** and select the upgrade file;
4. Press the button to confirm and the upgrade progress bar will pop up. After the upgrade is successful, it will restart, and if it fails, a prompt box will pop up.

Any operation that interrupts the upgrade process may cause the upgrade to fail or even the machine cannot start. Please keep the U disk in a stable state and the machine's power supply status during the upgrade process.

Voltage and current setting

By pressing the **Set** key, the cursor appears at the voltage setting. Press the **Set** key again to switch the cursor to the current setting. Press the left and right direction key  to switch the position of the cursor. Select the knob to change the value. After setting, press the knob Confirm, the setting is complete. Multi-channel model: After hiding the cursor, press  to switch the channel selection. The background of the channel in the upper status bar is highlighted to indicate that it is selected. Operate as above.

List setting

For single-channel models, press the **List** key on the panel to enter the List setting interface, press the knob or the **Set** key, and the selection cursor appears. At this time, press the up and down direction key  to switch the cursor to the parameter to be set, and press the left and right direction keys to switch the cursor position number. When the cursor is hidden, press  to turn the page and realize the setting of different groups of List output parameters.

For multi-channel models, after setting the channel mode to List mode in Menu → Configure → Channel Mode , set the List parameters as above.

Other configuration setting

Users can configure the system function through **Menu** → **Configure** :

1. Protect

Set the overvoltage protection (OVP) value and overcurrent protection value (OCP), and the ON/OFF of OCP.

2. Shunt

When set to Off, the internal bleeder circuit does not work.

3. Operating mode

You can set the power mode to CC or CV mode, and set the priority mode to high speed priority or slope priority. When it is set to slope priority, you can also set the slope value.

4. Output delay

On_dly: output delay when output is turned on, Off_dly: turn off delay when turning off the output.

5. Output resistance

It is equivalent to a resistor in series on the output terminal.

6. Measure average

Set the average number of readback parameters, three modes of Low, Mid, and High can be set.

7. Voltage control

The parameters Local, Ext_V (external voltage 0-10V control), Ext_R (external resistance 0-10K control) can be set.

8. Current control

Parameters can be set Local, Ext_V (external voltage 0-10V control), Ext_R (external resistance 0-10K control).

9. Ext on/off

Set the external control ON/OFF switch. When it is set to ON, the output is controlled by the low level of the rear analog interface pin15, and the output button on the front panel is invalid

10. Channel Mode

Multi-channel model configuration options, the parameters that can be set are Off, Normal, and List.

11. M/S mode settings

One in series: the master is set to Master/series through System → M/S mode settings, and one slave is set to Slave/series through System → M/S mode settings.

One in parallel: the master is set to Master/Parallel1 through System → M/S mode settings, and one slave is set to Slave/Parallel through System → M/S mode settings.

Connect two units in parallel: the master is set to Master/Parallel2 through System → M/S mode settings, and the two slaves are set to Slave/Parallel through System → M/S mode settings

Rear Analog Interface Wiring Method

One in series

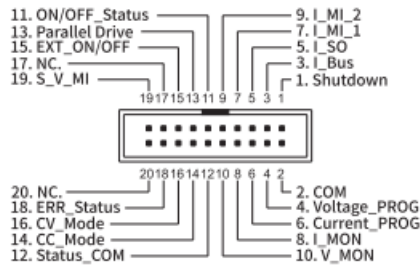
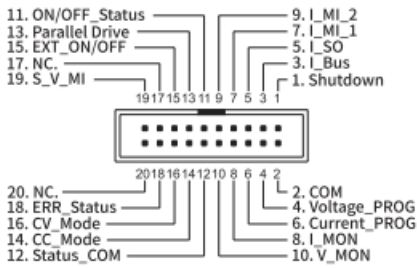
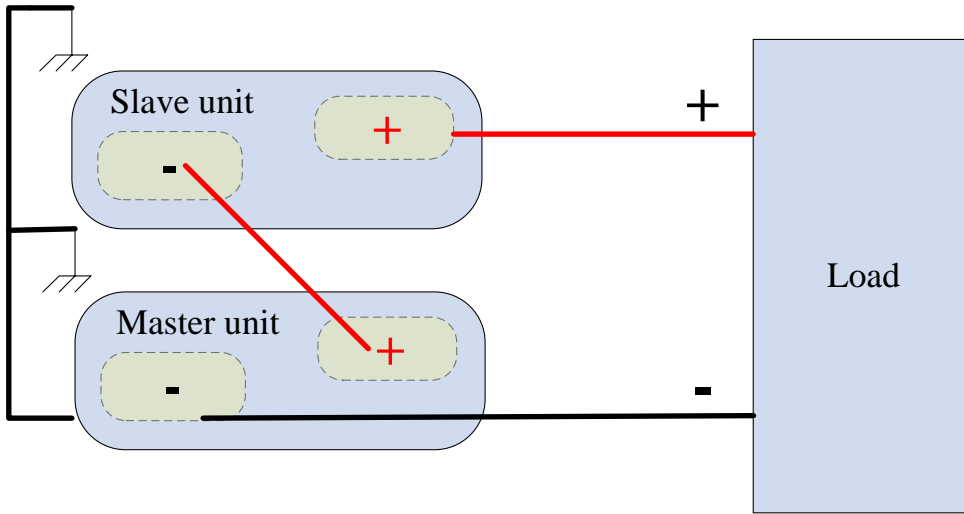

A1	_____	B18
A2	_____	B12
A2	_____	B19
A11	_____	B15
A12	_____	B2
A18	_____	B1

Connect two units in parallel

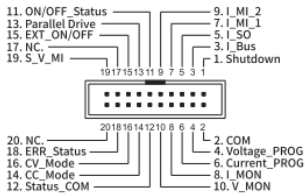
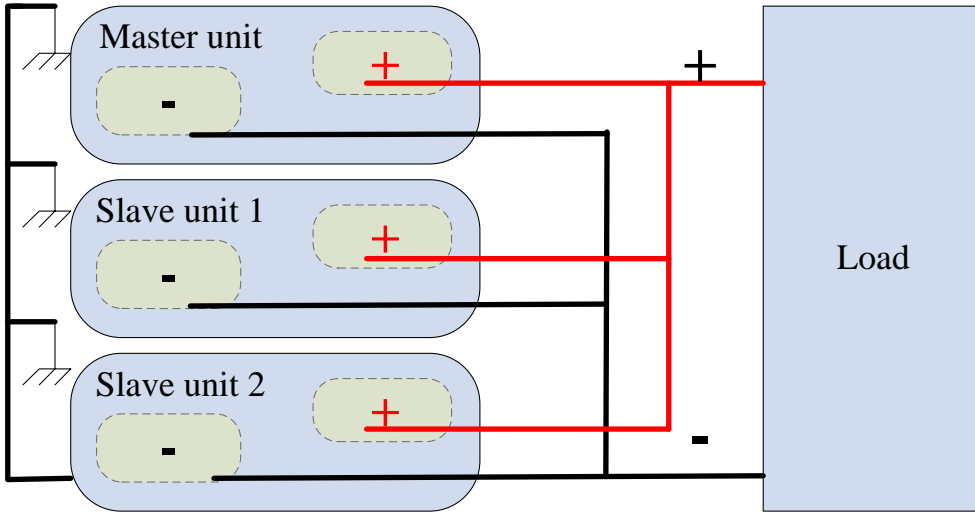

A:Master

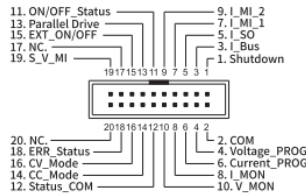

B:Slave

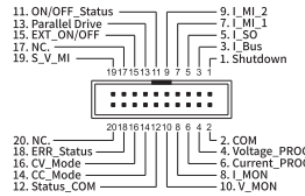

C:Slave

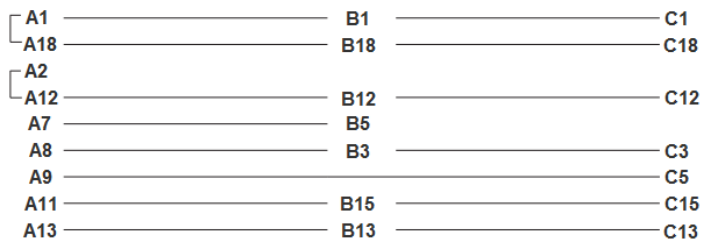

Remote

Based on the SCPI (Standard Commands for Programmable Instruments) command set, the power supply supports communication with the computer via USB, LAN, and GPIB-USB interfaces to realize remote control.

Press **Menu** → **Communication** to configure the remote control parameters of the power supply.

1. View the USB resource information of the power supply.
2. View and configure GPIB address.
3. LAN parameter settings, you can set the DHCP switch, IP address, gateway address and subnet mask address.

Method: after entering the LAN interface, press the knob and press to move the cursor position up and down. When is displayed, it means that the selected is On, and the IP is automatically obtained at this time. Turn the knob to switch On/Off, and press the knob to confirm the effect.

To manually set the IP, first set DHCP to Off according to the above method, press the knob to select Off, press the knob again and press **▲▼** to move the cursor up and down, the key **◀▶** can move the cursor left and right, turn the knob to change the value, press the knob Confirmation takes effect.

Web Service

Enter the IP address set on the machine directly into the Google browser to enter the web interface to achieve remote control of the power supply.

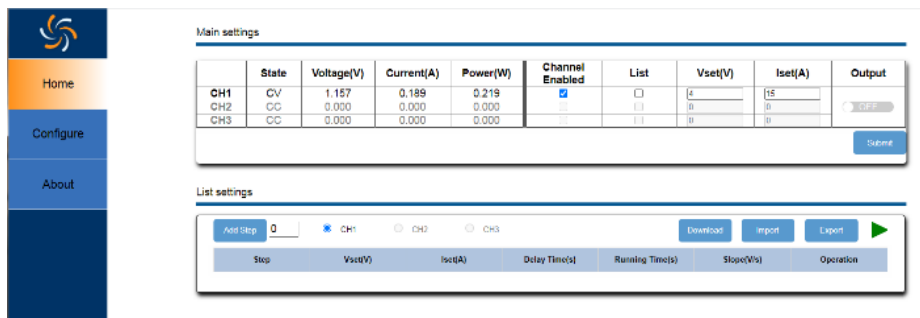

The screenshot displays the web interface for the power supply. On the left is a navigation menu with 'Home', 'Configure', and 'About' options. The main content area is divided into two sections: 'Main settings' and 'List settings'.

Main settings

	State	Voltage(V)	Current(A)	Power(W)	Channel Enabled	List	Vset(V)	Iset(A)	Output
CH1	CV	1.157	0.189	0.219	<input checked="" type="checkbox"/>	<input type="checkbox"/>	0	15	OFF
CH2	CC	0.000	0.000	0.000	<input type="checkbox"/>	<input type="checkbox"/>	0	0	OFF
CH3	CC	0.000	0.000	0.000	<input type="checkbox"/>	<input type="checkbox"/>	0	0	OFF

List settings

Buttons: Add Step, Download, Import, Export, Submit

Step	Vset(V)	Iset(A)	Delay Time(s)	Ramping Time(s)	Slope(V/s)	Operation
------	---------	---------	---------------	-----------------	------------	-----------

After setting the parameters, click **Submit** with the mouse and then the data will be sent to the power supply.

Troubleshooting

The following lists the possible failures and troubleshooting methods during the use of the power supply. When you encounter these faults, please follow the corresponding steps to deal with them. If you cannot deal with them, please contact SIGLENT in time.

1. If you press the power button, the power is still black without any display

- (1) Check whether the power connector is properly connected
- (2) After checking, please restart the power.
- (3) If the power supply still cannot be started normally, please contact SIGLENT.

2. Press Output without voltage output

- (1) Check whether the voltage and current settings are correct
- (2) Check whether it is in host mode, whether EXT on/off is in off state, Volt_ctrl and Curr_ctrl are in Local state, and whether the output resistance setting is reasonable. Whether the output delay time is too large or the slope mode setting is too small, which causes the output voltage to rise slowly.
- (3) Use the default setting to reset the voltage and current output after restoring the factory settings.
- (4) If the power supply still cannot be used normally, please contact SIGLENT.

3. U disk cannot be recognized

- (1) Check whether the U disk device can work normally.
- (2) Check whether the power USB HOST interface is working properly.
- (3) Make sure that the flash-type U disk is used, and the power supply does not support hard disk-type U disk devices.
- (4) Re-plug the U disk, or restart the power and insert the U disk again.
- (5) If you still cannot use the U disk normally, please contact SIGLENT.

More Information

For more information about this product, please refer to the following manual:

(You can log in to the SIGLENT website to download [Http://www.siglent.com](http://www.siglent.com))

“SPS5000X User Manual” Provide a detailed description of the functions of this product, as well as a detailed description of the SCPI commands and programming of this product.

“SPS5000X Data Sheet” Provide the main features and technical indicators of this product.

Headquarters:

SIGLENT Technologies Co., Ltd
Add: Bldg No.4 & No.5, Antongda Industrial
Zone, 3rd Liuxian Road, Bao'an District,
Shenzhen, 518101, China
Tel: + 86 755 3688 7876
Fax: + 86 755 3359 1582
Email: sales@siglent.com
Website: int.siglent.com

North America:

SIGLENT Technologies America, Inc
6557 Cochran Rd Solon, Ohio 44139
Tel: 440-398-5800
Toll Free: 877-515-5551
Fax: 440-399-1211
Email: info@siglentna.com
Website: www.siglentna.com

Europe:

SIGLENT Technologies Germany GmbH
Add: Staetzlinger Str. 70
86165 Augsburg, Germany
Tel: +49(0)-821-666 0 111 0
Fax: +49(0)-821-666 0 111 22
Email: info-eu@siglent.com
Website: www.siglenteu.com

Follow us on
Facebook: SiglentTech



2 7 7 4 0 1 0 5 9 1