

Digital Oscilloscope  
Handheld Oscilloscope  
Waveform Generator  
DC Power Supply  
DC Electronic Load  
Digital Multimeter  
Probes & Accessories

## SIGLENT TECHNOLOGIES PRODUCT CATALOG



# CATALOG

Company Profile .....	2
SDS7000A Super Phosphor Oscilloscope .....	3
SDS6000A Super Phosphor Oscilloscope .....	10
SDS6000L Low Profile Oscilloscope .....	15
SDS5000X Super Phosphor Oscilloscope .....	20
SDS3000X HD Super Phosphor Oscilloscope .....	24
SDS2000X HD Super Phosphor Oscilloscope .....	29
SDS2000X Plus Super Phosphor Oscilloscope .....	35
SDS2000X-E Super Phosphor Oscilloscope .....	39
SDS1000X HD Super Phosphor Oscilloscope .....	43
SDS800X HD Super Phosphor Oscilloscope .....	47
SDS1000X-E Super Phosphor Oscilloscope .....	52
SDS1000DL+/CML+ Digital Storage Oscilloscope .....	56
SHS1000X/SHS800X Handheld Oscilloscope .....	58
SDG7000A Arbitrary Waveform Generator .....	64
SDG6000X Pulse/Arbitrary Waveform Generator .....	71
SDG2000X Function/Arbitrary Waveform Generator .....	78
SDG1000X Function/Arbitrary Waveform Generator .....	83
SDG800 Function/Arbitrary Waveform Generator .....	87
SPS5000X Programmable Switching DC Power Supply .....	89
SPD3000 Programmable Linear DC Power Supply .....	93
SPD1000X Programmable Linear DC Power Supply .....	95
SDL1000X DC Electronic Load .....	98
SDM3065X Digital Multimeter .....	102
SDM3055 Digital Multimeter .....	105
SDM3045X Digital Multimeter .....	108
Probes & Accessories .....	111
Other Products Overview .....	116
Service .....	119

\* Spectrum Analyzer, Network Analyzer, RF Signal Generator can be found in SIGLENT RF PRODUCTS CATALOG

## SIGLENT TECHNOLOGIES Co., Ltd.

**Every Bench. Every Engineer. Every Day.**

**SIGLENT** has been providing test & measurement solutions for almost 18 years from its headquarter in Shenzhen, China. There are more than 300 employees, one third of whom are high-educated R&D engineers.

**SIGLENT** has many patent technologies. We are dedicated to develop sophisticated and high quality digital oscilloscopes, waveform generators, RF signal generators, handheld digital oscilloscopes, spectrum analyzers, vector network analyzers and DC power supplies, DC Electronic Loads, digital multimeters. We strive to deliver the highest quality of customer service and satisfaction to our customers.



### **SIGLENT provides the following instruments:**

- Digital Oscilloscope
- Handheld Oscilloscope
- Waveform Generator
- RF Signal Generator
- Spectrum Analyzer
- Vector Network Analyzer
- DC Power Supply
- DC Electronic Load
- Digital Multimeter
- Probes & Accessories

**SIGLENT** sincerely invite you to join

Please email :

[sales@siglent.com](mailto:sales@siglent.com)

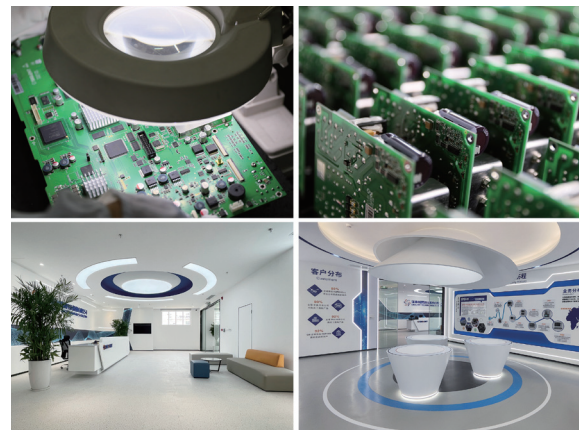



## SDS7000A Super Phosphor Oscilloscope

### Key Features

- 4 analog channels, up to 4 GHz bandwidth with up to 20 GSa/s sample rate
- 12-bit ADC
- Low background noise: 220  $\mu$ Vrms @ 4 GHz bandwidth
- SPO technology
  - Waveform capture rates up to 1,000,000 wfm/s
  - Supports 256-level intensity grading and color temperature display modes
  - 500 Mpts/ch standard, 1 Gpts/ch optional
  - Digital trigger system
- Intelligent trigger: Edge, Slope, Pulse, Window, Runt, Interval, Dropout, Pattern, Qualified, Nth edge, Setup/hold, Delay and Video (HDTV supported). Zone Trigger simplifies advanced triggering
- Serial bus triggering and decoder, supports protocols I2C, SPI, UART, CAN, LIN, CAN FD, FlexRay, I2S, MIL-STD-1553B, SENT, Manchester, ARINC429 and USB 2.0
- Segmented acquisition (Sequence) mode, dividing the maximum record length into multiple segments (up to 124,000), according to trigger conditions set by the user, with a very small dead time between segments to capture the qualifying event
- History waveform record (History) function, the maximum recorded waveform length is 124,000 frames
- Automatic measurements on 50+ parameters, supports statistics with histogram, track, trend, Gating measurement, and measurements on Math, History and Memory traces
- 4 Math traces (32 Mpts FFT, Filter, addition, subtraction, multiplication, division, integration, differential, square root, etc.), supports formula editor
- Abundant data analysis functions such as Search, Navigate, SignalScan, Digital Voltmeter, Counter, Waveform Histogram, Bode plot, Power Analysis, Eye/Jitter Analysis and Compliance Test
- High Speed hardware-based Average, Hi-Res; High Speed hardware-based Mask Test function, with Mask Editor tool for creating user-defined masks
- 16 digital channels (optional)
- Built-in 50 MHz waveform generator
- Large 15.6" HD TFT-LCD display with 1920 \* 1080 resolution; Capacitive touch screen supports multi-touch gestures
- Interfaces include: 4x USB Host 3.1 Gen 1, 2x USB 3.0 Host, USB 2.0 Device, 2x 1000M LAN, DVI-D, DP 1.2, HDMI 1.4, Audio, External Trigger In, Aux Out (Pass/Fail, Trigger Out), 10 MHz In, 10 MHz Out
- Built-in web server supports remote control over the LAN port using a web browser. Supports SCPI remote control commands. Supports external mouse and keyboard

## Characteristics

### • 12-bit High Resolution

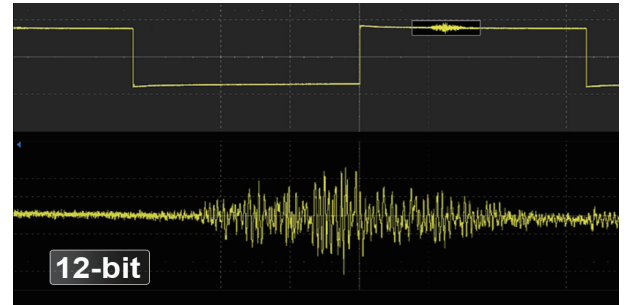
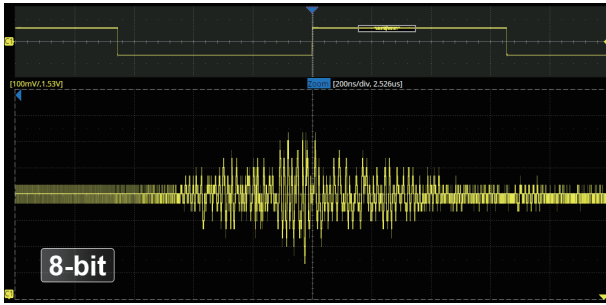

12-bit resolution shows you more details and less noise on the waveform.



### Upgraded processor system

Processor fully upgraded from the embedded ARM processor to the X86 processor, has greatly improved the system response speed and the speed of measurement, calculation, and analysis, presenting more possibilities for the expansion of software analysis functions in the future.



### Excellent User Interface and User Experience

- 15.6" HD display with 1920\*1080 resolution
- Capacitive touch screen, supporting multi-touch gestures, can move or scale the waveform traces quickly by finger-touch movements, which greatly improves the operational efficiency
- Built-in WebServer supports remote control on a web page over LAN
- Supports external mouse and keyboard

## • High Waveform Update Rate

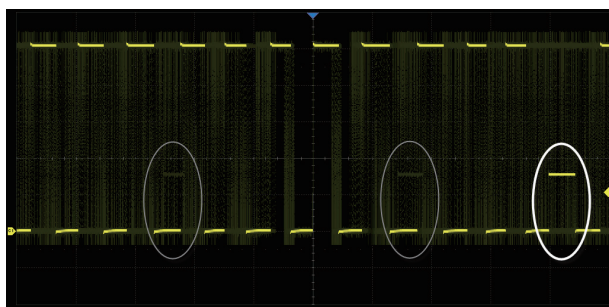

With a waveform update rate of up to 1,000,000 wfm/s, the oscilloscope can easily capture unusual or low-probability events. In Sequence mode, the waveform capture rate can reach 1,100,000 wfm/s

## • Multiple Trigger Functions

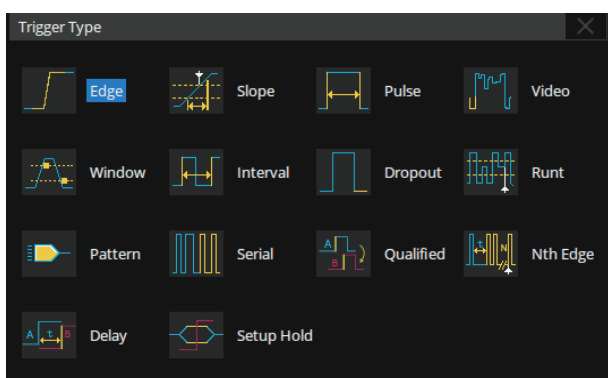

Edge, Slope, Pulse, Video, Windows, Runt, Interval, Dropout, Pattern, Qualified, Nth edge, Setup/hold, Delay and serial trigger

## • Advanced Math Function

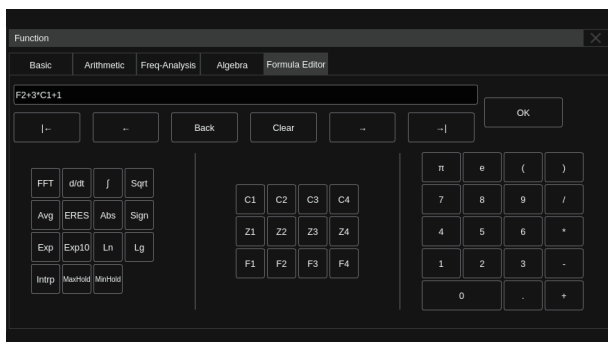

In addition to the traditional (+, -, X, /) operations, FFT, Filter, integration, differential, square root, and more are supported. Formula Editor is available for more complex operations. 4 math traces are available.

## • Deep Record Length

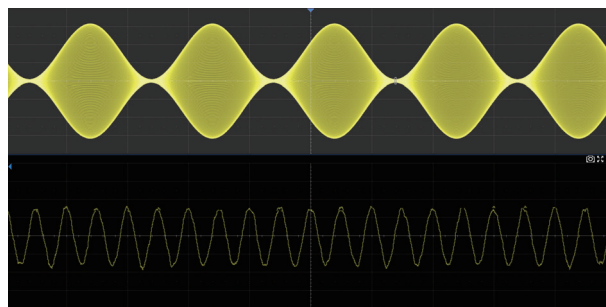

Using hardware-based Zoom technique and record length of up to 1 Gpts, users can select a slower timebase without compromising the sample rate, and then quickly zoom in to focus on the area of interest

## • Zone Trigger

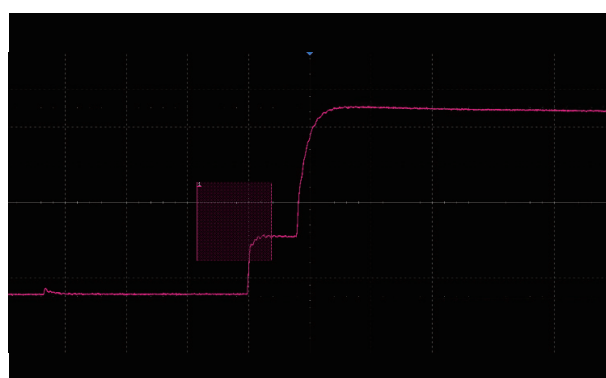

Zone Trigger is available for advanced triggering. Combine spatial triggering with common trigger modes to isolate signals of interest

## • Deep Memory FFT

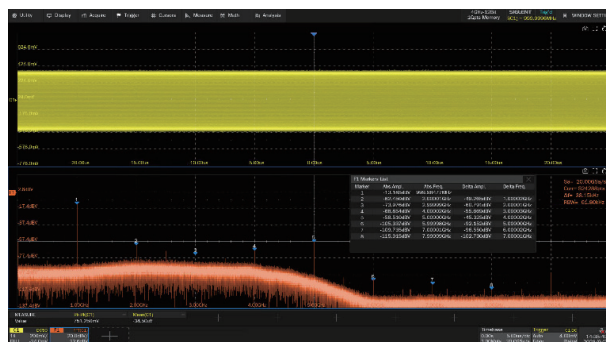

FFT supports up to 32 Mpts operation. This provides high-frequency resolution with a fast refresh rate. The FFT function also supports a variety of window functions so that it can adapt to different spectrum measurement needs. Three modes (Normal, Average, and Max hold) can satisfy different requirements for observing the power spectrum. Auto peak detection and markers are supported.

## • Measurements of a Variety of Parameters

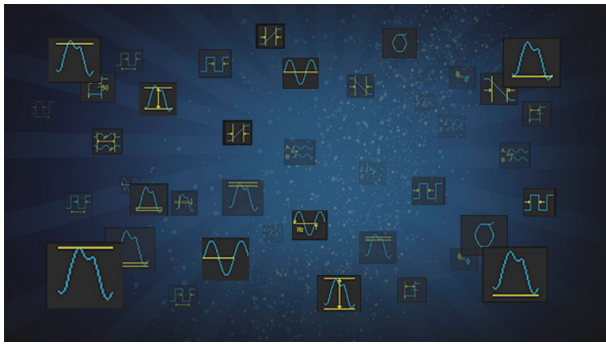

Parameter measurements include 4 categories: horizontal, vertical, miscellaneous, and CH delay providing a total of 50+ different types of measurements. Measurements can be performed within a specified gate period. Measurements on Math, Reference, and History frames are supported

## • History Mode

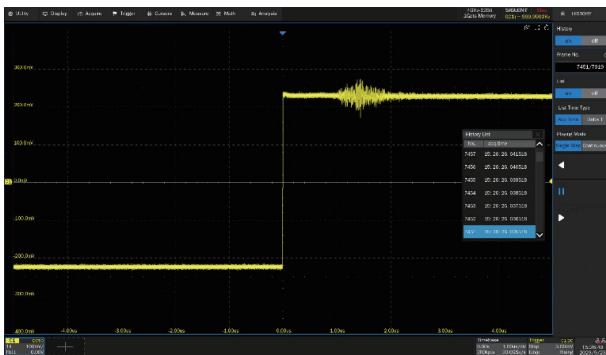

History function can record up to 124,000 frames of waveforms. The recording is executed automatically so that the customer can playback the history waveforms at any time to observe unusual events and quickly locate the area of interest using the cursors or measurements. The failed frames of the Mask Test can be stored as history

## • Hardware-based High Speed Mask Test Function

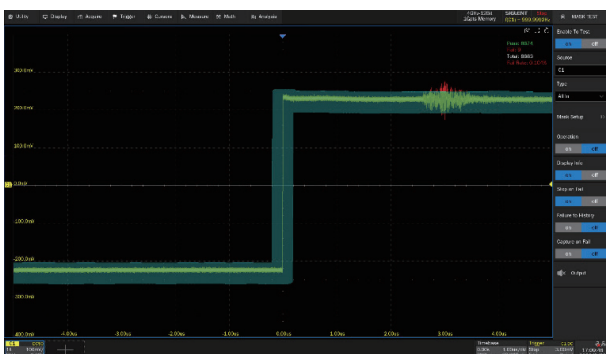

The oscilloscope utilizes a hardware-based Mask Test function, performing up to 80,000 Pass / Fail decisions each second. It is easy to generate user-defined test templates to provide trace mask comparisons, making it suitable for long-term signal monitoring or automated production line testing

## • Parameter Statistics Function



Statistics show the current value, maximum value, minimum value, standard deviation, and mean value of up to 12 parameters simultaneously. A histogram is available to show the probability distribution of a parameter. Trend and Track are available to show the parameter value vs. time.

For horizontal parameters such as period, all results are extracted from a frame, instead of just calculating the first one. This accelerates statistics on horizontal measurements and enables distribution observation in a frame using Histogram and Track

## • Sequence Mode

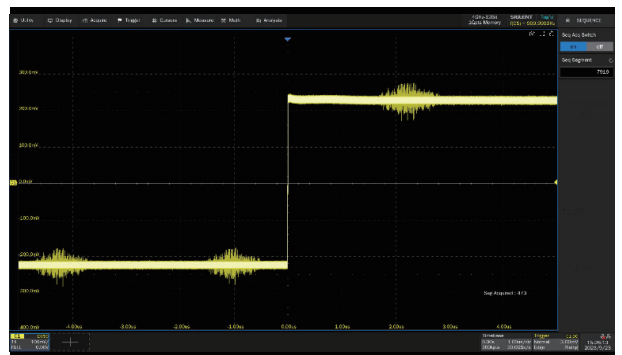

Segmented memory collection will store the waveform into multiple memory segments (up to 124,000) and each segment will store a triggered waveform as well the dead time information. The interval between segments can be as small as 0.9 μs. All of the segments can be played back using the History function

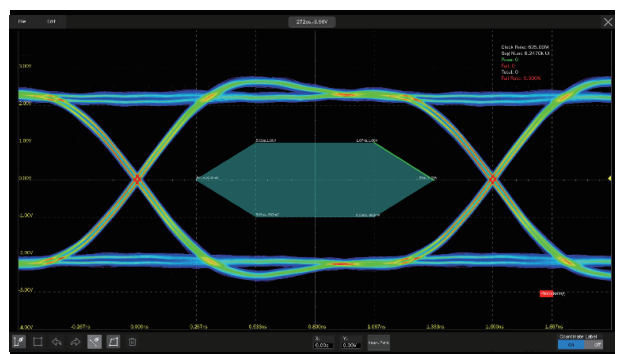

Built-in Mask Editor application helps to create custom masks



## Compliance Test (Optional)

USB 2.0, 100Base-TX, 1000Base-T, 100Base-T1, 1000Base-T1 protocol conformance testing are available. When the user sets up the environment according to the prompts, by using the related test fixture, the oscilloscope and related instruments can be automatically set up and related measurement, calculation, decoding and other functions will be used for testing, helping the user to complete each test project quickly and efficiently, and reports are generated automatically.

## • Bode Plot



The oscilloscope can control the Built-in waveform generator, SIGLENT isolated USB AWG module or a stand-alone SIGLENT SDG generator, to scan the amplitude and phase-frequency response of the DUT, and display the data as a Bode Plot. This makes it possible to replace expensive network analyzers in some applications

## • Power Analysis (Optional)



The Power Analysis option provides a full suite of power measurements and analysis, which greatly improve the measurement efficiency in switching power supplies and power devices design

## • Digital Channels/MSO (Optional)



Four analog channels plus 16 digital channels enable users to acquire and trigger the waveforms then analyze the pattern, simultaneously with one instrument

## • Built-in 50 MHz Function/Arbitrary Waveform Generator (Optional)

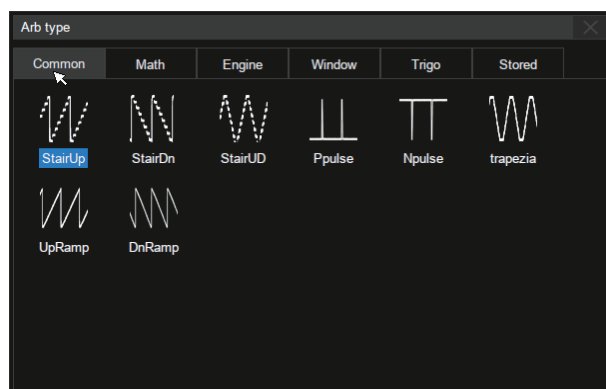

The oscilloscope can control the built-in waveform generator to output waveform with up to 50 MHz frequency and  $\pm 3$  V amplitude. Six basic waveforms plus multiple types of arbitrary waveforms are built-in





## 5 GHz Active Differential Probe

The SAP5000D differential probe is provided with 5GHz bandwidth, 80 ps rise time, 400 fF differential input capacitance, and 10:1 attenuation ratio

## Complete Connectivity

- 2x USB 3.0 Host, 4x USB Host 3.1 Gen 1, USB 2.0 Device, USBTMC, 2x 1000M LAN (VXI-11+SCPI, Telnet (5024)+SCPI, Socket (5025) +SCPI, LXI, WebServer)
- 1x DVI-D: up to 1920x1200 @ 60Hz, 1x DP 1.2: up to 4096x2304 @ 60Hz, 1x HDMI 1.4: up to 4096x2160 @ 60Hz
- Mic input, Audio Output
- External Trigger In, Aux Out (TRIG OUT, PASS/FAIL), 10 MHz In, 10 MHz Out



## Specifications

Model	SDS7404A H12	SDS7304A H12
Analog channels	4 + EXT	
Bandwidth	4 GHz	3 GHz
Sample rate (Max.)	20 GSa/s (dual-channel) 10 GSa/s (3 or 4 channels)	
Vertical Resolution	12-bit Up to 16-bit in ERES mode	
Memory depth (Max.)	Standard: 500 Mpts/ch Optional: 1 Gpts/ch in dual-channel mode	
Waveform capture rate (Max.)	1,000,000 wfms/s	
Trigger type	Edge, Slope, Pulse width, Window, Runt, Interval, Dropout, Pattern, Video, Qualified, Nth edge, Setup/hold, Delay, Serial	
Serial trigger and decode	Standard: I2C, SPI, UART, CAN, LIN Optional: CAN FD, FlexRay, I2S, MIL-STD-1553B, SENT, Manchester (decode only), ARINC429, USB 2.0 (decode only)	
Measurement	50+ parameters, statistics, histogram, trend, and track supported	
Math	4 traces 32 Mpts FFT, +, -, x, ÷, ∫dt, d/dt, √, Identity, Negation, Absolute, Sign, ex, 10x, ln, lg, Interpolation, MaxHold, MinHold, ERES, Average, Filter. Supports formula editor	
Data analysis	Search, Navigate, History, Mask Test, Digital Voltmeter, Counter, Waveform Histogram, Bode plot and Power Analysis, Eye/Jitter Analysis, SignalScan, Compliance Test (USB 2.0, 100Base-TX, 1000Base-T, 100Base-T1, 1000Base-T1)	
Digital channel (optional)	16-channel; maximum sample rate up to 1 GSa/s; record length up to 50 Mpts	
Waveform generator (optional)	Built-in, frequency up to 50 MHz, 125 MSa/s sample rate, 16 kpts waveform memory	

Processor System	Intel Core i3-8100 or better, 32GB memory, 250GB storage, Linux operating system
Data analysis	I/O: 4x USB Host 3.1 Gen 1, 2x USB 3.0 Host, USB 2.0 Device (USBTMC), 2x 1000M LAN (VXI-11+SCPI, Telnet (5024)+SCPI, Socket (5025) +SCPI, LXI, WebServer) Display: 1x DVI-D: up to 1920x1200 @ 60Hz; 1x DP 1.2: up to 4096x2304 @ 60Hz; 1x HDMI 1.4: up to 4096x2160 @ 60Hz Audio: Mic input, Audio Output Others: External Trigger In, Aux Out (TRIG OUT, PASS/FAIL), 10 MHz In, 10 MHz Out
Probe (Standard)	500 MHz, 1 probe supplied for each channel
Display	15.6" HD TFT-LCD with capacitive touch screen (1920*1080)

## Ordering Information

Model	Description
SDS7404A H12	4 GHz, 20 GSa/s, 4-CH, 12-bit, standard 500 Mpts/ch memory depth, 15.6" capacitive touch screen
SDS7304A H12	3 GHz, 20 GSa/s, 4-CH, 12-bit, standard 500 Mpts/ch memory depth, 15.6" capacitive touch screen
Standard Accessories	
	Quantity
USB cable	1
Quick start	1
Passive probe (SP3150A)	1/channel
Certificate of calibration	1
Wireless mouse	1
Power cord	1
Protective Cover	1
Optional Accessories	
	Part No.
16-channel logic probe	SPL2016
Power Analysis deskew fixture	DF2001A
USB 2.0 test fixture	FX-USB2
Ethernet test fixture	FX-ETH
Automotive Ethernet test fixture	FX-AMETH
STB3 demo signal source	STB3
USB-GPIB adapter	USB-GPIB
High-speed active probe	SAP1000, SAP2500
High voltage probe	HPB4010
High-speed differential probe	SAP2500D, SAP5000D
High voltage differential probe	DPB1300/DPB4080/DPB5150/ DPB5150A/DPB5700/DPB5700A
Current probe	CPL5100/CP4020/CP4050/CP4070/CP4070A CP6030/CP6030A/CP6150/CP6500
Transit case	CASE-S2
Options	
	Part No.
Waveform generator (software)	SDS7000A-FG
16 digital channels (software)	SDS7000A-16LA
Power Analysis (software)	SDS7000A-PA
Eye Diagram/Jitter Analysis (software)	SDS7000A-EJ
I2S trigger & decode (software)	SDS7000A-I2S
MIL-STD-1553B trigger & decode (software)	SDS7000A-1553B
FlexRay trigger & decode (software)	SDS7000A-FlexRay
CAN FD trigger & decode (software)	SDS7000A-CANFD
SENT trigger & decode (software)	SDS7000A-SENT
Manchester decode (software)	SDS7000A-Manch
ARINC429 trigger & decode (software)	SDS7000A-ARINC
USB 2.0 decode (software)	SDS7000A-USB2
USB 2.0 compliance test (software)	SDS7000A-CT-USB2
100Base-TX compliance test (software)	SDS7000A-CT-100BASE-T
1000Base-T compliance test (software)	SDS7000A-CT-1000BASE-T
100Base-T1 compliance test (software)	SDS7000A-CT-100BASE-T1
1000Base-T1 compliance test (software)	SDS7000A-CT-1000BASE-T1
1Gpts memory depth (software)	SDS7000A-1GPTS
OCXO timebase (Assembled and calibrated in factory only)	10M_OCXO_L

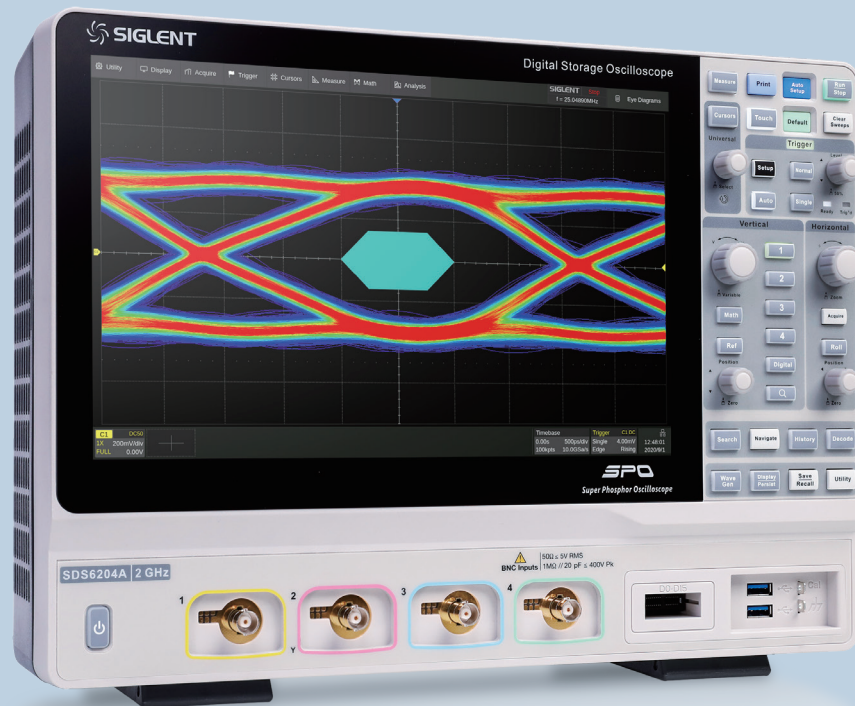

## SDS6000A Super Phosphor Oscilloscope

### Key Features

- 4 analog channels, up to 2 GHz bandwidth with 5 GSa/s (10 GSa/s ESR) sample rate at each channel
- Low background noise, supports 0.5 mV/div to 10 V/div vertical scales
- SPO technology
  - Waveform capture rates up to 170,000 wfm/s (normal mode), and 750,000 wfm/s (sequence mode)
  - Supports 256-level intensity grading and color temperature display modes
  - 500 Mpts Record length in total for all 4 channels
  - Digital trigger system
- Intelligent trigger: Edge, Slope, Pulse, Window, Runt, Interval, Dropout, Pattern, Qualified, Nth edge, Setup/hold, Delay and Video (HDTV supported). Zone Trigger simplifies advanced triggering
- Serial bus triggering and decoder, supports protocols I2C, SPI, UART, CAN, LIN, CAN FD, FlexRay, I2S, MIL-STD-1553B, SENT and Manchester
- Segmented acquisition (Sequence) mode, dividing the maximum record length into multiple segments (up to 80,000), according to trigger conditions set by the user, with a very small dead time between segments to capture the qualifying event
- History waveform record (History) function, the maximum recorded waveform length is 80,000 frames
- Automatic measurements on 50+ parameters, supports statistics with histogram, track, trend, Gating measurement, and measurements on Math, History and Ref
- 4 Math traces (8 Mpts FFT, addition, subtraction, multiplication, division, integration, differential, square root, etc.), supports formula editor
- Abundant data analysis functions such as Search, Navigate, Digital Voltmeter, Counter, Waveform Histogram, Bode plot, Power Analysis and Eye/Jitter Analysis
- High Speed hardware-based Average, Hi-Res; High Speed hardware-based Mask Test function, with Mask Editor tool for creating user-defined masks
- 16 digital channels (optional)
- 25 MHz function / arbitrary waveform generator, built-in multiple predefined waveforms
- Large 12.1" TFT-LCD display with 1280 \* 800 resolution; Capacitive touch screen supports multi-touch gestures
- Interfaces include: USB Hosts, USB Device (USBTMC), LAN(VXI-11/Telnet/Socket), micro SD card, Pass/Fail, Trigger Out, HDMI
- Built-in web server supports remote control over the LAN port using a web browser. Supports SCPI remote control commands. Supports external mouse and keyboard

## Characteristics



### Excellent User Interface and User Experience

- 12.1" display with 1280\*800 resolution
- Capacitive touch screen, supporting multi-touch gestures, can move or scale the waveform traces quickly by finger-touch movements, which greatly improves the operation efficiency
- Built-in WebServer supports remote control on a web page over LAN
- Supports external mouse and keyboard

### • High Waveform Update Rate

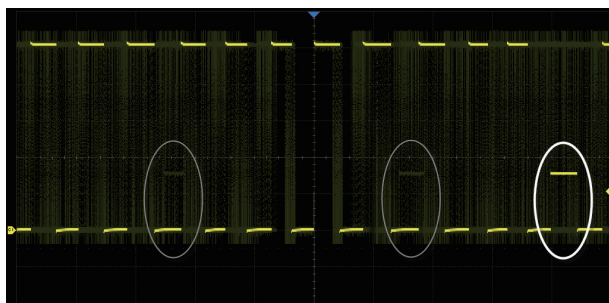

With a waveform update rate of up to 170,000 wfms/s, the oscilloscope can easily capture unusual or low-probability events. In Sequence mode, the waveform capture rate can reach 750,000 wfms/s

### • Deep Record Length

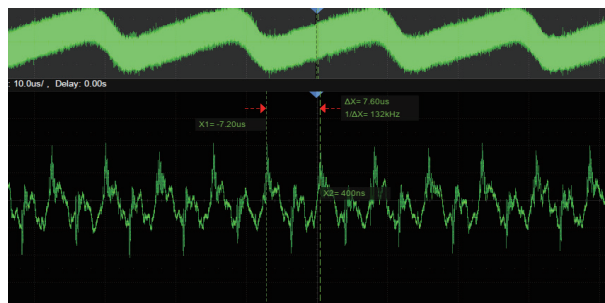

Using hardware-based Zoom technique and record length of up to 500 Mpts, users can select a slower timebase without compromising the sample rate, and then quickly zoom in to focus on the area of interest

### • Multiple Trigger Functions

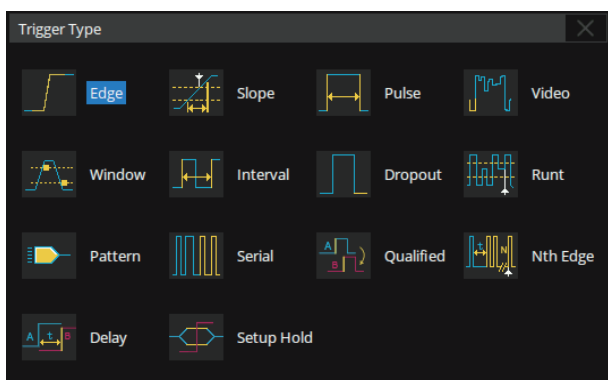

Edge, Slope, Pulse, Video, Windows, Runt, Interval, Dropout, Pattern, Qualified, Nth edge, Setup/hold, Delay and serial trigger

### • Trigger Zone

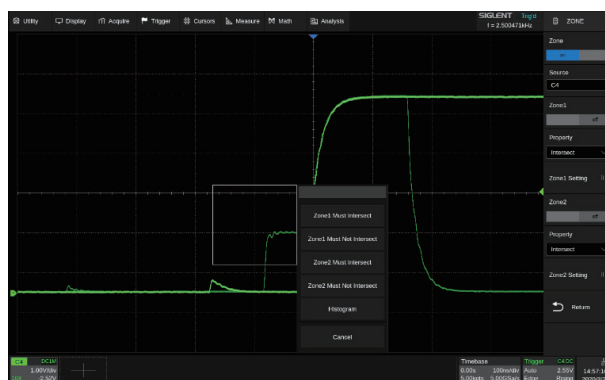

Trigger Zone is available for advanced triggering

## • Hardware-based High Speed Mask Test Function

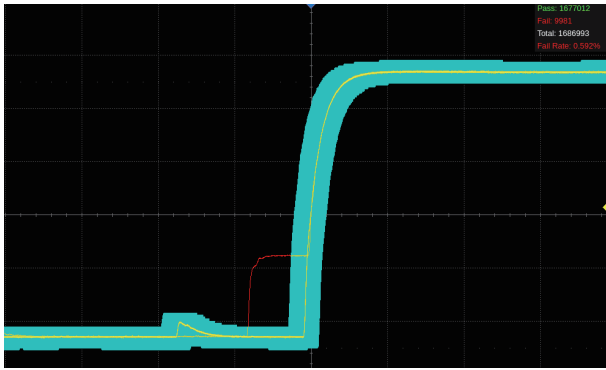

The oscilloscope utilizes a hardware-based Mask Test function, performing up to 18,000 Pass / Fail decisions each second. It is easy to generate user-defined test templates to provide trace mask comparisons, making it suitable for long-term signal monitoring or automated production line testing

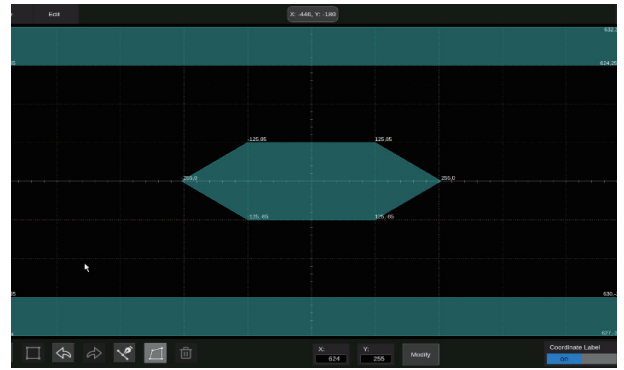

Built-in Mask Editor application helps to create custom masks

## • Eye/Jitter Analysis

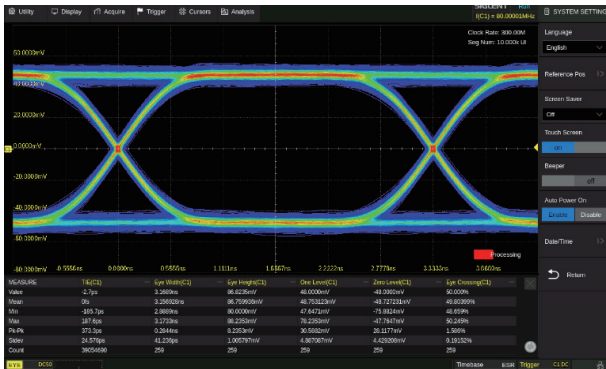

Supports eye diagram and jitter analysis/measurement. It can automatically extract the embedded reference clock from serial data and create the eye diagram. Measurement on multiple eye/jitter parameters is provided. Mask test on eye diagrams is supported

## • Bode Plot

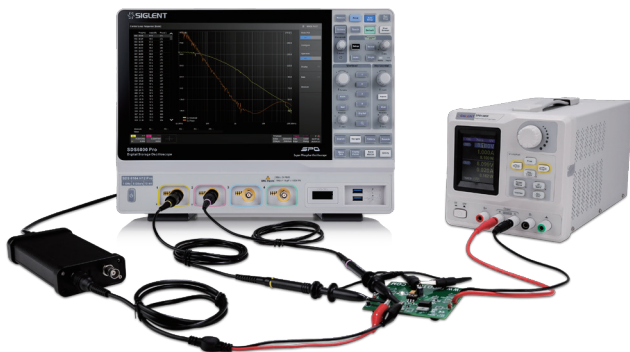

The oscilloscope can control the isolated USB AWG module or a stand-alone SIGLENT SDG generator, to scan the amplitude and phase-frequency response of the DUT, and display the data as a Bode Plot. This makes it possible to replace expensive network analyzers in some applications

## • Power Analysis (Optional)

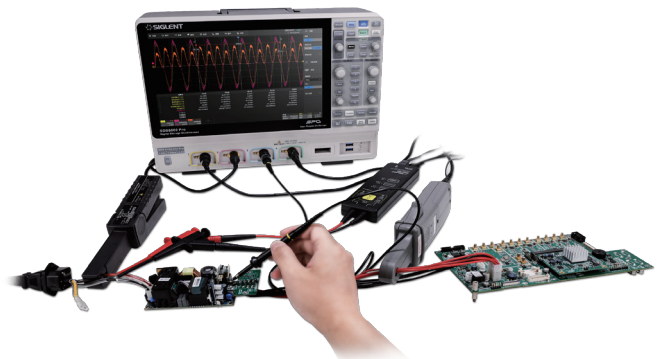

The Power Analysis option provides a full suite of power measurements and analysis, which greatly improve the measurement efficiency in switching power supplies and power devices design

## • Digital Channels / MSO (Optional)



Four analog channels plus 16 digital channels enable users to acquire and trigger the waveforms then analyze the pattern, simultaneously with one instrument

## • Serial Bus Decode



Display the decoded characters through the events list. Bus protocol information can be quickly and intuitively displayed in tabular form. I2C, SPI, UART, CAN, LIN, CAN FD, FlexRay, I2S, MIL-STD-1553B, SENT, and Manchester are supported

## • Complete Connectivity



USB Host 3.0 x2, USB Host 2.0 x2, USB Device 2.0 (USBTMC) x1, LAN (VXI-11/Telnet/Socket) x1, micro SD card x1, Auxiliary output (Pass/Fail, Trigger Out)x1 and HDMI x1

## Specifications

Model	SDS6204A	SDS6104A	SDS6054A
Bandwidth	2 GHz	1 GHz	500 MHz
Sampling rate (Max.)	5 GSa/s (10 GSa/s ESR) @ each channel		
Analog channels	4 + EXT		
Memory depth (Max.)	500 Mpts/ch(single-channel), 250 Mpts/ch (dual-channel) , 125 Mpts/ch (3 or 4 channels)		
Waveform capture rate (Max.)	Normal mode: 170,000 wfm/s; Sequence mode: 750,000 wfm/s		
Vertical resolution	8-bit, up to 16-bit in Hi-Res mode		
Trigger type	Edge, Slope, Pulse width, Window, Runt, Interval, Dropout, Pattern, Video, Qualified, Nth edge, Setup/hold, Delay, Serial		
Serial trigger and decode	Standard: I2C, SPI, UART, CAN, LIN Optional: CAN FD, FlexRay, I2S, MIL-STD-1553B, SENT, Manchester (decode only)		
Measurement	50+ parameters, statistics, histogram, trend, and track supported		
Math	4 traces 8 Mpts FFT, +, -, x, ÷, fdt, d/dt, √, Identity, Negation, Absolute, Sign, ex, 10x, ln, lg, Interpolation, MaxHold, MinHold. Supports formula editor		
Data analysis	Search, Navigate, History, Mask Test, Digital Voltmeter, Counter, Waveform Histogram, Bode plot and Power Analysis, Eye/Jitter Analysis		
Digital channel (optional)	16-channel; maximum sample rate up to 1 GSa/s; record length up to 50 Mpts		

Waveform generator (optional)	Single-channel external USB isolated waveform generator, frequency up to 25 MHz, 125 MSa/s sample rate, 16 kpts waveform memory
I/O	USB 3.0 Host x2, USB 2.0 Host x2, USB 2.0 Device, LAN, micro SD card, HDMI, External trigger, Auxiliary output (TRIG OUT, PASS/FAIL)
Probe (Standard)	SP3150A, 500 MHz, 1 probe supplied for each channel
Display	12.1 TFT-LCD with capacitive touch screen (1280*800)

## Ordering Information

Model	Description
SDS6204A	2 GHz, 10 GSa/s, 4-CH, 500 Mpts/ch memory depth, 12.1" capacitive touch screen
SDS6104A	1 GHz, 5 GSa/s, 4-CH, 500 Mpts/ch memory depth, 12.1" capacitive touch screen
SDS6054A	500 MHz, 5 GSa/s, 4-CH, 500 Mpts/ch memory depth, 12.1" capacitive touch screen
Standard Accessories	
Quantity	
USB cable	1
Quick start	1
Passive probe (SP3150A)	1/channel
Certificate of calibration	1
Wireless mouse	1
Power cord	1
Optional Accessories	
Part No.	
Waveform generator (software)	SDS6000Pro-FG
25 MHz isolated USB function/arbitrary waveform generator	SAG1021I
16 digital channels (software)	SDS6000Pro-16LA
16-channel logic probe	SPL2016
Power Analysis (software)	SDS6000Pro-PA
Power Analysis deskew fixture	DF2001A
Eye Diagram/Jitter Analysis (software)	SDS6000Pro-EJ
I2S trigger & decode (software)	SDS6000Pro-I2S
MIL-STD-1553B trigger & decode (software)	SDS6000Pro-1553B
FlexRay trigger & decode (software)	SDS6000Pro-FlexRay
CAN FD trigger & decode (software)	SDS6000Pro-CANFD
SENT trigger & decode (software)	SDS6000Pro-SENT
Manchester decode (software)	SDS6000Pro-Manch
500 MHz to 1 GHz bandwidth upgrade (software)	SDS6000-4BW10
1 GHz to 2 GHz bandwidth upgrade (software)	SDS6000-4BW20
STB3 demo signal source	STB3
High-speed active probe	SAP1000, SAP2500
High voltage probe	HPB4010
High-speed differential probe	SAP2500D
High voltage differential probe	DPB1300/DPB4080/DPB5150/ DPB5150A/DPB5700/DPB5700A
Current probe	CPL5100/CP4020/CP4050/CP4070/CP4070A/CP5030/CP5030A/CP5150/CP5500
Rack Mount Kit	SDS6000-RMK
Bag	BAG-S2



## SDS6000L Low Profile Digital Storage Oscilloscope

### Key Features

- 8/4 analog channels + 1 external trigger. Designed for expansion. Combine multiple units for a high-speed acquisition system with up to 512 channels.
- Up to 2 GHz bandwidth with 5 GSa/s (10 GSa/s ESR) sample rate at each channel
- Low background noise, supports 0.5 mV/div to 10 V/div vertical scales
- SPO technology
  - Waveform capture rates up to 170,000 wfm/s (normal mode), and 750,000 wfm/s (sequence mode)
  - Supports 256-level intensity grading and color temperature display modes
  - 500 Mpts Record length in total for all 4 channels
  - Digital trigger system
- Intelligent trigger: Edge, Slope, Pulse, Window, Runt, Interval, Dropout, Pattern, Qualified, Nth edge, Setup / hold, Delay and Video (HDTV supported). Zone Trigger simplifies advanced triggering
- Serial bus triggering and decoder, supports protocols I2C, SPI, UART, CAN, LIN, CAN FD, FlexRay, I2S, MIL-STD-1553B, SENT and Manchester
- Segmented acquisition (Sequence) mode, dividing the maximum record length into multiple segments (up to 80,000), according to trigger conditions set by the user, with a very small dead time between segments to capture the qualifying event
- History waveform record (History) function, the maximum recorded waveform length is 80,000 frames
- Automatic measurements on 50+ parameters, supports statistics with histogram, track, trend, Gating measurement, and measurements on Math, History, Memory and Ref
- 4 Math traces (8 Mpts FFT, addition, subtraction, multiplication, division, integration, differential, square root, etc.), supports formula editor
- Abundant data analysis functions such as Search, Navigate, Digital Voltmeter, Counter, Waveform Histogram, Power Analysis and Eye/Jitter Analysis
- 16 digital channels (optional)
- 25 MHz function / arbitrary waveform generator, built-in multiple predefined waveforms
- Interfaces include: 4x USB Hosts, USB Device (USBTMC), 1000M LAN (VXI-11/ Telnet/ Socket), micro SD card, Pass/Fail, Trigger Out, HDMI, 10MHz In, 10MHz Out
- Built-in web server supports remote control over the LAN port using a web browser. Supports SCPI remote control commands. Supports external mouse and keyboard



## Characteristics

### Flexible Multi-channel High-speed Acquisition System

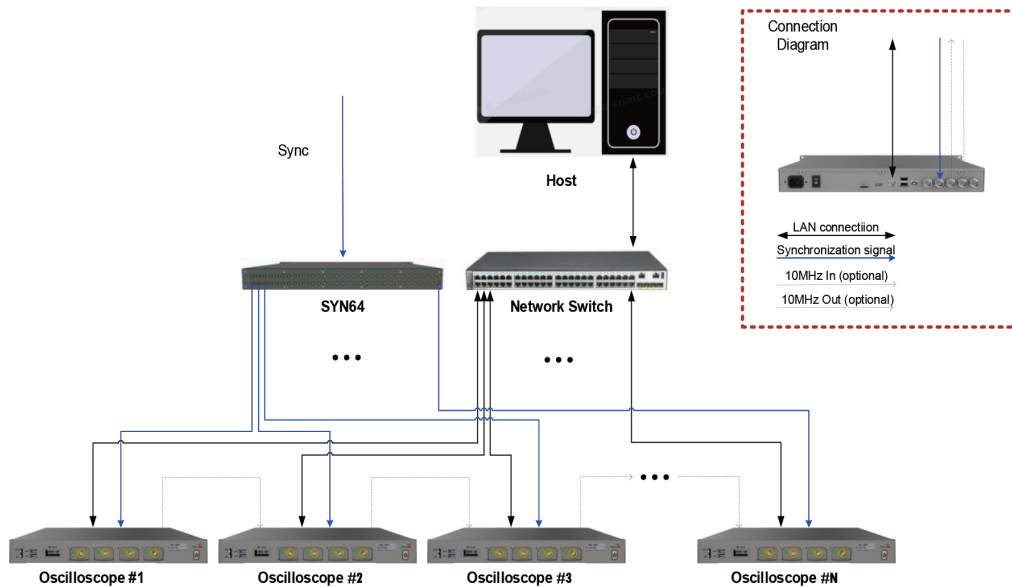

- Standard sizes: 4 - channel models – 1U, 8-channel models – 2U
- Multiple units are combined to create a high-speed acquisition system with up to 512 channels by being triggered with low-skew synchronization signals from the 64-channel synchronization distributor SYN64
- The host can access each unit over 1000M LAN. A complete SCPI command set as well as LabVIEW and IVI drivers are provided for easy data acquisition. The LAN port is LXI compliant.
- Sample clocks are synchronized between all units in the test system by cascading the 10 MHz In and 10 MHz Out clocks in a daisy chain

### • High Waveform Update Rate

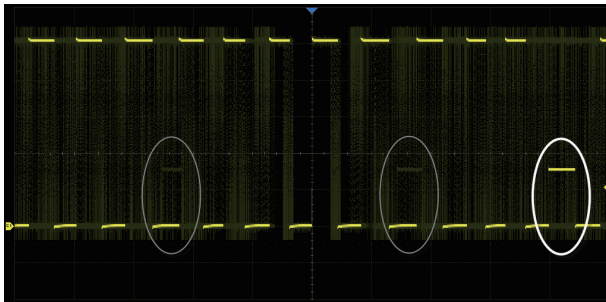

With a waveform update rate of up to 170,000 wfms/s, the oscilloscope can easily capture unusual or low-probability events. In Sequence mode, the waveform capture rate can reach 750,000 wfms/s

### • Deep Record Length

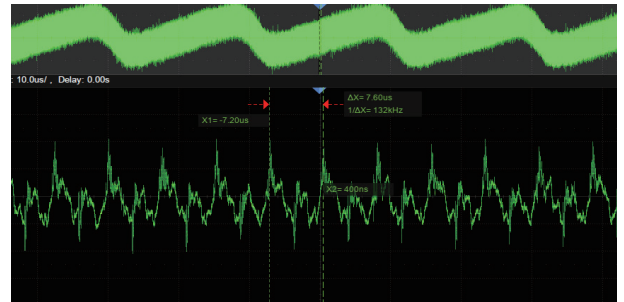

Using hardware-based Zoom technique and record length of up to 500 Mpts, users can select a slower timebase without compromising the sample rate, and then quickly zoom in to focus on the area of interest

### • Multiple Trigger Functions

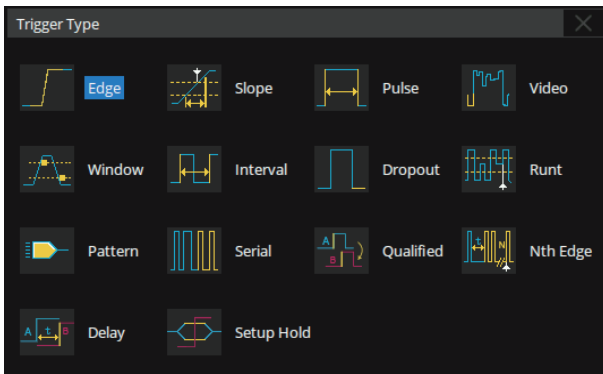

Edge, Slope, Pulse, Video, Windows, Runt, Interval, Dropout, Pattern, Qualified, Nth edge, Setup/ hold, Delay, and serial trigger

### • Trigger Zone

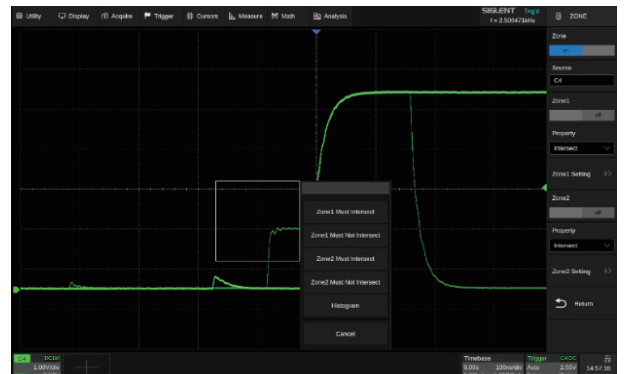

Trigger Zone is available for advanced triggering

## • Search and Navigate

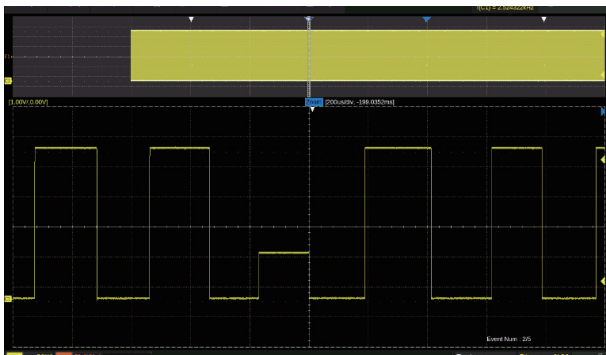

The oscilloscope can search events specified by the user in a frame. Events flagged by the Search can be recalled automatically using Navigate. It can also navigate by time (delay position) and history frames

## • Hardware-based High Speed Mask Test Function

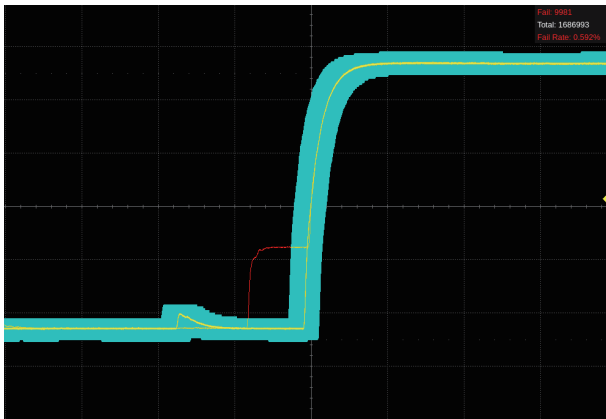

The oscilloscope utilizes a hardware-based Mask Test function, performing up to 18,000 Pass / Fail decisions each second. It is easy to generate user-defined test templates to provide trace mask comparisons, making it suitable for long-term signal monitoring or automated production line testing

## • Eye / Jitter Analysis



Supports eye diagram and jitter analysis / measurement. It can automatically extract the embedded reference clock from serial data and create an eye diagram. Measurement on multiple eye / jitter parameters is provided and mask testing of eye diagrams is supported

## • Serial Bus Decode



Display the decoded characters through the events list. Bus protocol information can be quickly and intuitively displayed in tabular form. I2C, SPI, UART, CAN, LIN, CAN FD, FlexRay, I2S, MIL-STD-1553B, SENT, and Manchester are supported

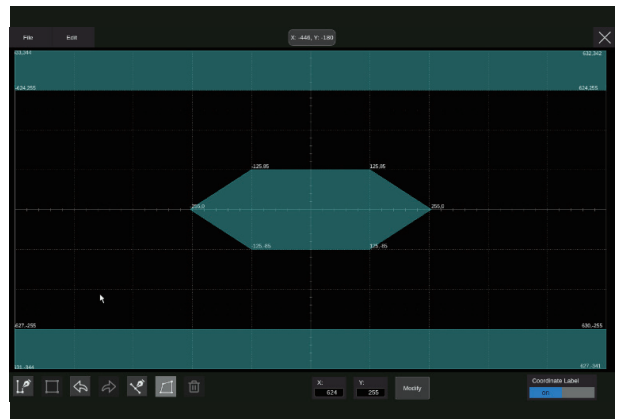

Built-in Mask Editor application helps to create custom masks



## ● Power Analysis (Optional)

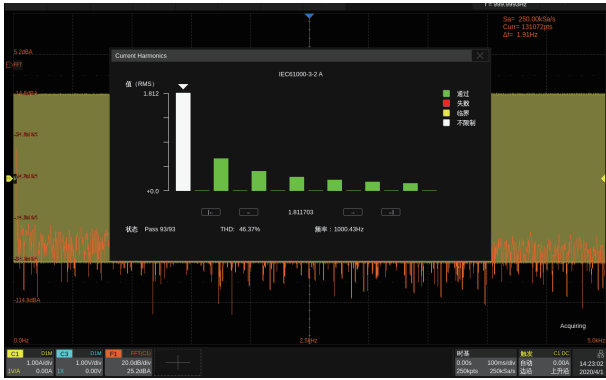

The Power Analysis option provides a full suite of power measurements and analysis, which greatly improves the measurement efficiency in switching power supplies and power devices design

## ● Digital Channels / MSO (Optional)



Four analog channels plus 16 digital channels enable users to acquire and trigger the waveforms and then analyze the pattern, simultaneously with one instrument

## Specifications

Channel	Model	2 GHz	1 GHz	500 MHz
8		SDS6208L	SDS6108L	SDS6058L
4		SDS6204L	SDS6104L	SDS6054L

Model	SDS6208L SDS6204L	SDS6108L SDS6104L	SDS6058L SDS6054L
Channel	8/4 + EXT		
Bandwidth	2 GHz	1 GHz	500 MHz
Sample rate (Max.)	5 GSa/s (10 GSa/s ESR) @ each channel		
Memory depth (Max.)	500 Mpts/ch (single-channel) 250 Mpts/ch (dual-channel) 125 Mpts/ch (3 or 4 channels)		
Waveform capture rate (Max.)	Normal mode: 170,000 wfm/s; Sequence mode: 750,000 wfm/s		
Vertical resolution	8-bit Up to 12-bit in ERES mode, equivalent to 16-bit Hi-Res mode		
Trigger type	Edge, Slope, Pulse width, Window, Runt, Interval, Dropout, Pattern, Video, Qualified, Nth edge, Setup/hold, Delay, Serial		
Serial trigger and decode	Standard: I2C, SPI, UART, CAN, LIN Optional: CAN FD, FlexRay, I2S, MIL-STD-1553B, SENT, Manchester (decode only)		
Measurement	50+ parameters, statistics, histogram, trend, and tracking supported		
Math	4 traces 8 Mpts FFT, +, -, x, ÷, fdt, d/dt, √, Identity, Negation, Absolute, Sign, ex, 10x, ln, lg, Interpolation, MaxHold, MinHold, ERES, Average. Supports formula editor		
Data analysis	Search, Navigate, History, Mask Test, Digital Voltmeter, Counter, Waveform Histogram, Power Analysis, Eye / Jitter Analysis		
Digital channel (optional)	16-channel; maximum sample rate up to 1 GSa/s; record length up to 50 Mpts		
Waveform generator (optional)	Single-channel external USB isolated waveform generator, frequency up to 25 MHz, 125 MSa/s sample rate, 16 kpts waveform memory		
I/O	HDMI (1280*800), USB 3.0 Host x2, USB 2.0 Host x2, USB 2.0 Device (USBTMC), 1000M LAN (SCPI over VXI-11, SCPI over Telnet (port:5024), SCPI over Socket (port:5025), micro SD card, External trigger, Auxiliary output (TRIG OUT,PASS / FAIL), 10 MHz In, 10 MHz Out		
Probe (Standard)	1x 500 MHz passive probe supplied for each channel		

### Multiple-channel Acquisition System

Channel	Up to 512		
Jitter	Within a unit: < 100 ps,rms    Between units:< 250 ps,rms		
Skew	Without skew calibration, within a unit: < 100 ps    Between units: < 500 ps With skew calibration, within a unit: < 100 ps    Between units: < 150 ps		

## Ordering Information

Model	Description
SDS6208L	2 GHz bandwidth, 5 GSa/s sample rate, 8-bit, 500 Mpts memory depth, 8-channel
SDS6204L	2 GHz bandwidth, 5 GSa/s sample rate, 8-bit, 500 Mpts memory depth, 4-channel
SDS6108L	1 GHz bandwidth, 5 GSa/s sample rate, 8-bit, 500 Mpts memory depth, 8-channel
SDS6104L	1 GHz bandwidth, 5 GSa/s sample rate, 8-bit, 500 Mpts memory depth, 4-channel
SDS6058L	500 MHz bandwidth, 5 GSa/s sample rate, 8-bit, 500 Mpts memory depth, 8-channel
SDS6054L	500 MHz bandwidth, 5 GSa/s sample rate, 8-bit, 500 Mpts memory depth, 4-channel

Standard Accessories	Quantity
USB cable	1
Quick start	1
Passive probe	1/channel
Certificate of calibration	1
Wireless mouse	1
Power cord	1

Optional Accessories	Part No.
Waveform generator (software)	SDS6000L-FG
16 digital channels (software)	SDS6000L-16LA
16-channel logic probe	SPL2016
Power Analysis (software)	SDS6000L-PA
Power Analysis deskew fixture	DF2001A
Eye Diagram/Jitter Analysis (software)	SDS6000L-EJ
I2S trigger & decode (software)	SDS6000L-I2S
MIL-STD-1553B trigger & decode (software)	SDS6000L-1553B
FlexRay trigger & decode (software)	SDS6000L-FlexRay
CAN FD trigger & decode (software)	SDS6000L-CANFD
SENT trigger & decode (software)	SDS6000L-SENT
Manchester decode (software)	SDS6000L-Manch
STB3 demo signal source	STB3
High-speed active probe	SAP1000, SAP2500
High voltage probe	HPB4010
High-speed differential probe	SAP2500D
High voltage differential probe	DPB1300 / DPB4080 / DPB5150 / DPB5150A / DPB5700 / DPB5700A
Current probe	CPL5100 / CP4020 / CP4050 / CP4070 / CP4070A / CP6030 / CP6030A / CP6150 / CP6500
64-channel synchronization distributor	SYN64



## SDS5000X Super Phosphor Oscilloscope

### Key Features

- 1 GHz, 500 MHz, 350 MHz models with real-time sampling rate up to 5 GSa/s
- SPO technology
  - Waveform capture rate up to 110,000 wfm/s (normal mode), and 500,000 wfm/s (sequence mode)
  - Supports 256-level intensity grading and color temperature display modes
  - Record length up to 250 Mpts
  - Digital trigger system
- Intelligent trigger: Edge, Slope, Pulse Window, Runt, Interval, Dropout, Pattern, Qualified and Video (HDTV supported)
- Serial bus triggering and decoder, supports protocols I<sup>2</sup>C, SPI, UART, CAN, LIN, CAN FD, FlexRay, I<sup>2</sup>S and MIL-STD-1553B
- Low background noise, supports 0.5 mV/div to 10 V/div voltage scales
- Segmented acquisition (Sequence) mode, dividing the maximum record length into multiple segments (up to 100,000), according to trigger conditions set by the user, with a very small dead time segments to capture the qualifying event
- History waveform record (History) function, the maximum recorded waveform length is 100,000 frames
- Automatic measurement function on more than 70 kinds of parameters, supports statistics, Gating measurement, Math measurement, History measurement and Ref measurement
- Math function (2 Mpts FFT, addition, subtraction, multiplication, division, integration, differential, square root)
- Search and Navigate
- Digital Voltmeter
- High Speed hardware-based Average, ERES (Enhanced Resolution)
- 16 digital channels (optional) with maximum waveform capture rate up to 1.25 GSa/s, record length up to 62.5 Mpts
- 25 MHz function / arbitrary waveform generator, built-in multiple predefined waveforms
- Large 10.1" TFT-LCD display with 1024 \* 600 resolution; Capacitive touch screen supports multi-touch gestures
- Supports external mouse and keyboard
- 10 types of one-button shortcuts
- Multiple interfaces: USB Host, USB Device (USBTMC), LAN (VXI-11, telnet, socket, web), Pass / Fail, Trigger Out, 10 MHz In, 10 MHz Out, VGA output
- Built-in web server supports remote control by the LAN port using a web browser
- Supports SCPI remote control commands

## Characteristics

- 10.1" TFT-LCD display with capacitive touch screen



- 10.1" display with 1024\*600 resolution
- Capacitive touch screen, supporting multi-touch gestures, can move or scale the waveform traces quickly by finger-touch movements, which greatly improves the operation efficiency.

- Record Length of up to 250 Mpts/ch



Using hardware-based Zoom technique and record length of up to 250 Mpts, users are able to select a slower timebase without compromising the sampling rate, and then quickly zoom in to focus on the area of interest

- Serial Bus Decode

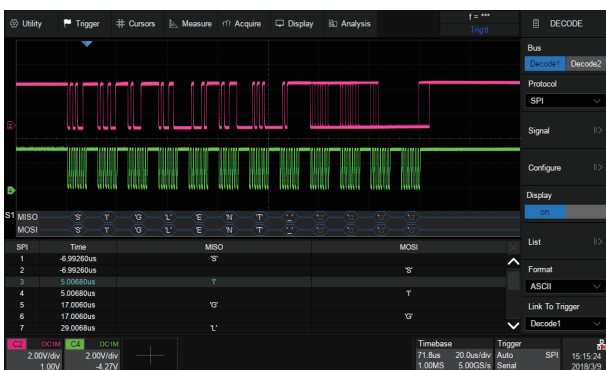

Display the decoded characters through the events list. Bus protocol information can be quickly and intuitively displayed in tabular form. I2C, SPI, UART, CAN, LIN, CAN FD, FlexRay and I2S and MIL-STD-1553B are supported

- Zone Trigger

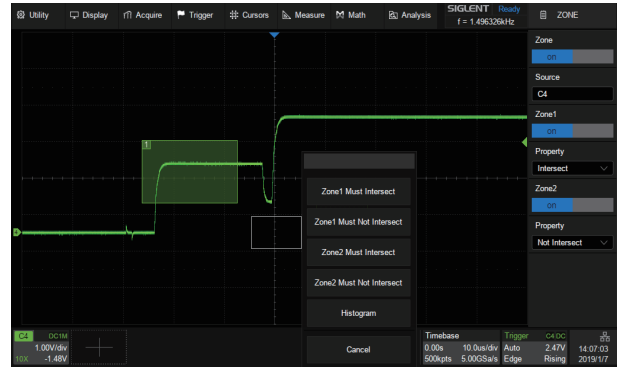

Zone Trigger is available for advanced triggering

- Multiple Trigger Functions

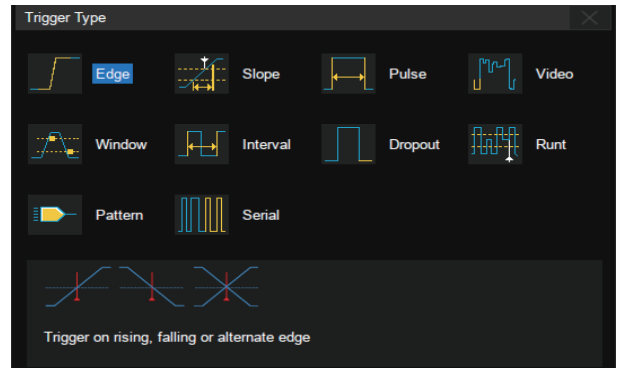

Edge, Slope, Pulse, Video, Windows, Runt, Interval, Dropout, Pattern, Qualified, Nth edge, Setup/hold, Delay and serial trigger

- Measurements of a Variety of Parameters

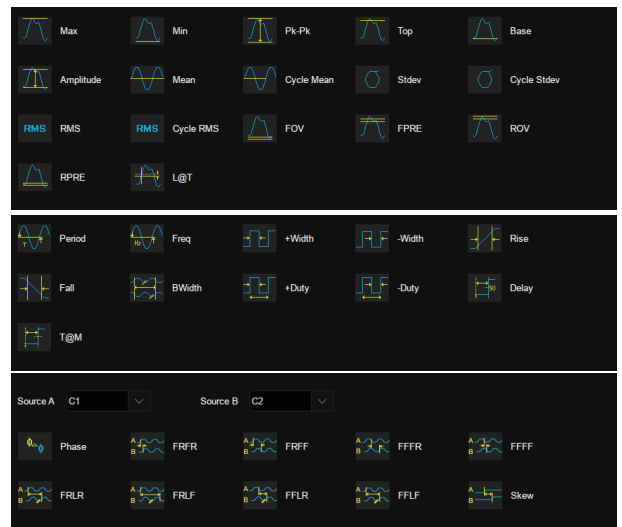

Parameter measurements includes 3 categories: horizontal, vertical and CH delay providing more than 70 different types of measurements. Measurements can be performed within a specified gate period. Measurements on Math, Reference and History frames are supported

## • Digital Voltmeter Function



4-digit voltmeter and 7-digit frequency counter. Any analog channel can be selected as a source. Bar, Histogram and Trend diagrams are supported

## • Bode Plot

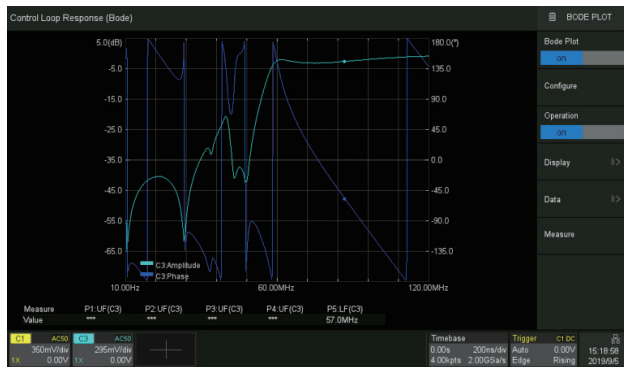

The SDS5000X can control the USB AWG module or a stand-alone SIGLENT SDG generator, to scan the amplitude and phase frequency response of the DUT, and display the data as a Bode Plot. This makes it possible to replace expensive network analyzer in some applications.

## • Digital Channels / MSO (Optional)

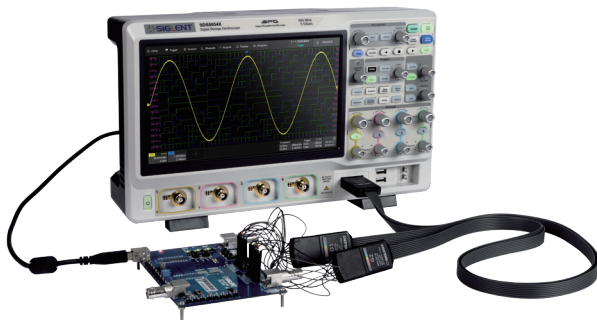

Four analog channels plus 16 digital channels enable users to acquire and trigger on the waveforms then analyze the pattern, simultaneously with one instrument

## • Web control



With the new embedded web server, users can control the oscilloscope from a simple web page. This provides wonderful remote troubleshooting and monitoring capabilities.

## • Power Analysis (Optional)



The Power Analysis option provides a full suite of power measurements and analysis, which greatly improve the measurement efficiency in switching power supplies and power devices design.

## • Built-in 25 MHz Function / Arbitrary Waveform Generator (Optional)



the SDS5000X can control the SAG1021I USB Function / Arbitrary waveform generator to output waveform with up to 25 MHz frequency and  $\pm 3$  V amplitude. Six basic waveforms plus multiple types of arbitrary waveforms are built-in.

## • Hardware-based Average and ERES Acquisition

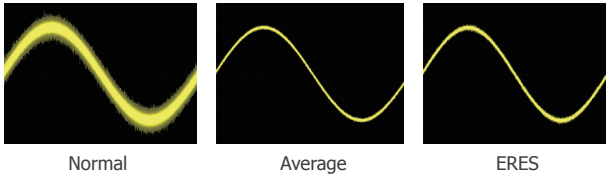

Average and ERES (Enhanced Resolution) acquisition modes are hardware-based, allowing the waveforms to be captured at a faster rate

## • Complete Connectivity



USB Host, USB Device (USBTMC), LAN (VXI-11, telnet, socket, web), Pass / Fail, Trigger Out, 10 MHz In / Out and VGA output

## Specifications

Model	SDS5034X	SDS5054X	SDS5104X
Bandwidth	350 MHz	500 MHz	1 GHz
Sampling rate (Max.)	5 GSa/s (interleaving mode), 2.5 GSa/s (non-interleaving mode)		
Analog channels	4 + EXT		
Memory depth (Max.)	250 Mpts (interleaving mode), 125 Mpts (non-interleaving mode)		
Waveform capture rate(Max.)	110,000 wfm/s (normal mode), 500,000 wfm/s (sequence mode)		
Trigger type	Edge, Slope, Pulse width, Window, Runt, Interval, Dropout, Pattern, Video, Qualified		
Serial trigger and decode	I <sup>2</sup> C, SPI, UART, CAN, LIN, CAN FD, FlexRay, I <sup>2</sup> S, MIL-STD-1553B		
Digital channel (optional)	16-channel; maximum waveform capture rate up to 1.25 GSa/s; record length up to 62.5 Mpts		
Waveform generator (optional)	Single channel, frequency up to 25 MHz, 125 MSa/s sample rate, 16 kpts waveform memory		
I / O	USB Host, USB Device, LAN, Pass / Fail, Trigger Out, 10 MHz In, 10 MHz Out, VGA Output		
Probe (standard)	1 probe supplied for each channel		
Display	10.1" TFT-LCD with capacitive touch screen (1024*600)		

## Ordering Information

Description	Model
1 GHz, 4 CH, 5 GSa/s (Max.)	SDS5104X
500 MHz, 4 CH, 5 GSa/s (Max.)	SDS5054X
350 MHz, 4 CH, 5 GSa/s (Max.)	SDS5034X
<b>Standard Accessories</b>	
USB cable x1	Quick start x1
Certificate of calibration x1	Power cord x1
Passive probe x2 (2-ch model); x4 (4-ch model), SP2035A for 350 MHz models and SP3050A for 500 MHz / 1 GHz models	
<b>Optional Accessories</b>	
SDS-5000X-4BW05	350 MHz to 500 MHz bandwidth upgrade(4-ch model)
SDS-5000X-2BW05	350 MHz to 500 MHz bandwidth upgrade (2-ch model)
SDS-5000X-4BW10	500 MHz to 1 GHz bandwidth upgrade (4-ch model)
SDS-5000X-2BW10	500 MHz to 1 GHz bandwidth upgrade (2-ch model)
SDS-5000X-FG	Waveform generator software
SAG1021I	25 MHz USB function / arbitrary waveform generator
SDS-5000X-16LA	16 digital channels (software)
SPL2016	16-channel logic probe
SDS-5000X-I2S	I2S trigger & decode
SDS-5000X-CANFD	CAN FD trigger & decode
SDS-5000X-FlexRay	FlexRay trigger & decode
SDS-5000X-1553B	MIL-STD-1553B trigger & decode
STB3	STB3 demo signal source
SAP1000	1 GHz active probe
HPB4010	High voltage probe
CP4020 / CP4050 / CP4070 / CP4070A / CP5030 / CP5030A / CP5150 / CP5500	Current probe
DPB4080 / DPB5150 / DPB5150A / DPB5700 / DPB5700A	High voltage differential probe





## SDS3000X HD Super Phosphor Oscilloscope

### Key Features

- 4 analog channels, up to 1 GHz bandwidth with up to 4GSa/s sample rate
- 12-bit ADC
- Low background noise: 125  $\mu$ Vrms @ 1 GHz bandwidth
- SPO technology
  - Waveform capture rates up to 200,000 wfms in Normal mode and 890,000 wfms in Sequence mode
  - Supports 256-level intensity grading and color temperature display modes
  - Up to 400 Mpts/ch record length
  - Digital trigger system
- Intelligent trigger: Edge, Slope, Pulse, Window, Runt, Interval, Dropout, Pattern, Qualified, Nth edge, Setup/hold, Delay and Video (HDTV supported). Zone Trigger simplifies advanced triggering
- Serial bus triggering and decoder, supports protocols I2C, SPI, UART, CAN, LIN, CAN FD, FlexRay, I2S, MIL-STD-1553B, SENT, Manchester and ARINC429
- Segmented acquisition (Sequence) mode, dividing the maximum record length into multiple segments (up to 80,000), according to trigger conditions set by the user, with a very small dead time between segments to capture the qualifying event
- History waveform record (History) function, the maximum recorded waveform length is 80,000 frames
- Automatic measurements on 50+ parameters, supports statistics with histogram, track, trend, Gating measurement, and measurements on Math, History and Memory traces
- 4 Math traces (4 Mpts FFT, Filter, addition, subtraction, multiplication, division, integration, differential, square root, etc.), supports formula editor
- Abundant data analysis functions such as Search, Navigate, Digital Voltmeter, Counter, Waveform Histogram, Bode plot and Power Analysis
- High Speed hardware-based Average, ERES; High Speed hardware-based Mask Test function, with Mask Editor tool for creating user-defined masks
- 16 digital channels (optional)
- External 50 MHz waveform generator (optional)
- Large 10.1" TFT-LCD display with 1024 \* 600 resolution; Capacitive touch screen supports multi-touch gestures
- Interfaces include: 2x USB 3.0 Host, 1x USB 2.0 Host, USB 3.0 Device (USBTMC), 1000M LAN ((VXI-11/Telnet/Socket/LXI)), External Trigger In, Aux Out (Pass/Fail, Trigger Out)
- Built-in web server supports remote control over the LAN port using a web browser. Supports SCPI remote control commands. Supports external mouse and keyboard

## Characteristics

### • 12-bit High Resolution

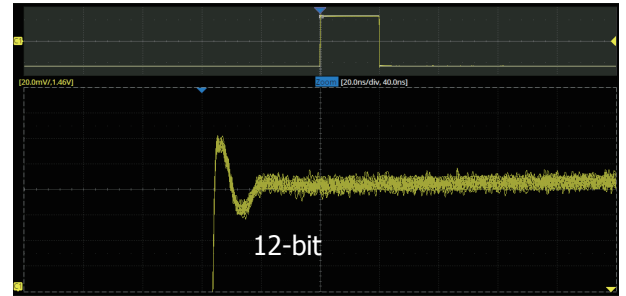
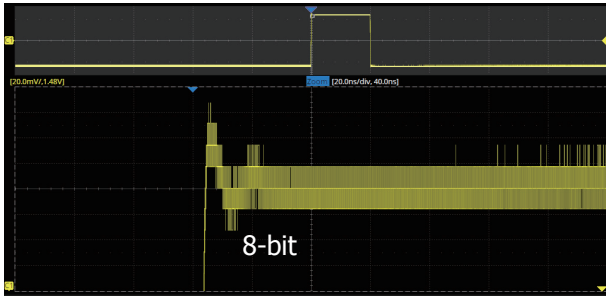

12-bit resolution shows you more details and less noise on the waveform

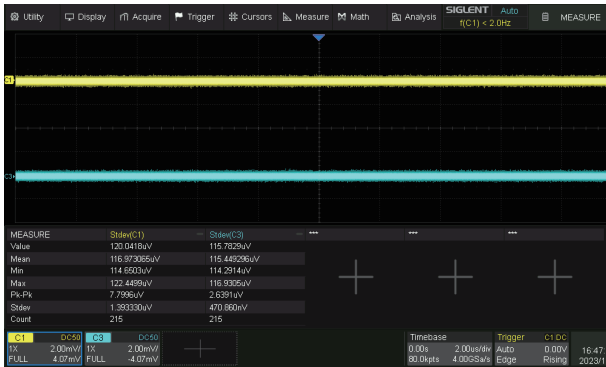

Low noise floor: 125  $\mu$ Vrms at 1 GHz bandwidth

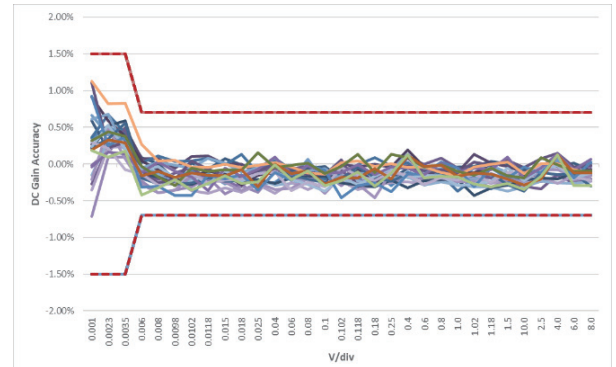

0.5% DC gain accuracy

### • Excellent User Interface and User Experience



- 10.1" display with 1024x600 resolution
- Capacitive touch screen, supporting multi-touch gestures, can move or scale the waveform traces quickly by finger-touch movements, which greatly improves the operation efficiency
- Built-in WebServer supports remote control on a web page over LAN
- Supports external mouse and keyboard

### • Multiple Trigger Functions

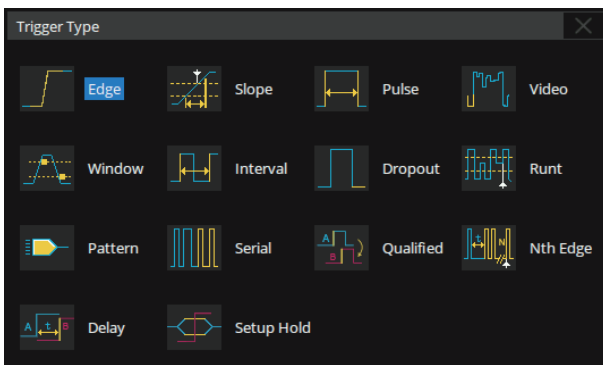

Edge, Slope, Pulse, Video, Windows, Runt, Interval, Dropout, Pattern, Qualified, Nth edge, Setup/hold, Delay and serial trigger

### • Zone Trigger

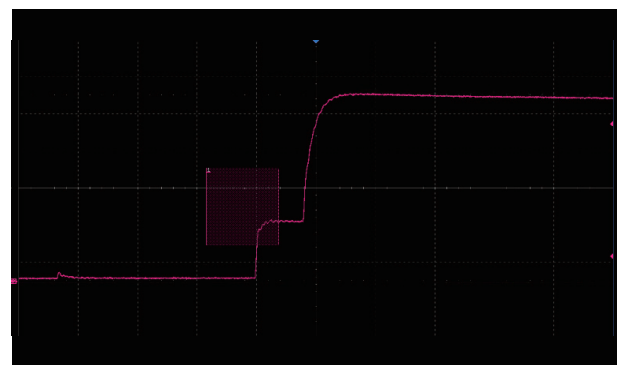

Zone Trigger is available for advanced triggering. Combine spatial triggering with common trigger modes to isolate signals of interest

## • Deep Memory FFT

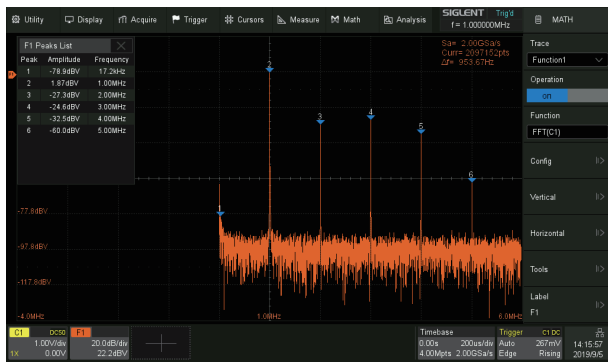

FFT supports up to 4 Mpts operation. This provides high-frequency resolution with a fast refresh rate. The FFT function also supports a variety of window functions so that it can adapt to different spectrum measurement needs. Three modes (Normal, Average, and Max hold) can satisfy different requirements for observing the power spectrum. Auto peak detection and markers are supported.

## • Hardware-based High Speed Mask Test Function

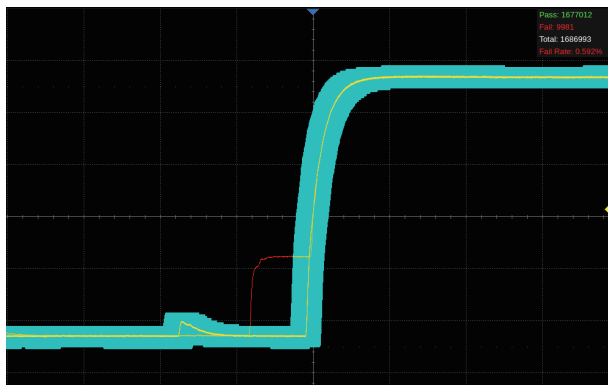

The oscilloscope utilizes a hardware-based Mask Test function, performing up to 28,000 Pass / Fail decisions each second. It is easy to generate user-defined test templates to provide trace mask comparisons, making it suitable for long-term signal monitoring or automated production line testing

## • Bode Plot



The oscilloscope can control the SIGLENT isolated USB AWG module or a stand-alone SIGLENT SDG generator, to scan the amplitude and phase-frequency response of the DUT, and display the data as a Bode Plot. This makes it possible to replace expensive network analyzers in some applications

## • Serial Bus Decode



Display the decoded characters through the events list. Bus protocol information can be quickly and intuitively displayed in tabular form. I2C, SPI, UART, CAN, LIN, CAN FD, FlexRay, I2S, MIL-STD-1553B, SENT, Manchester and ARINC429 are supported

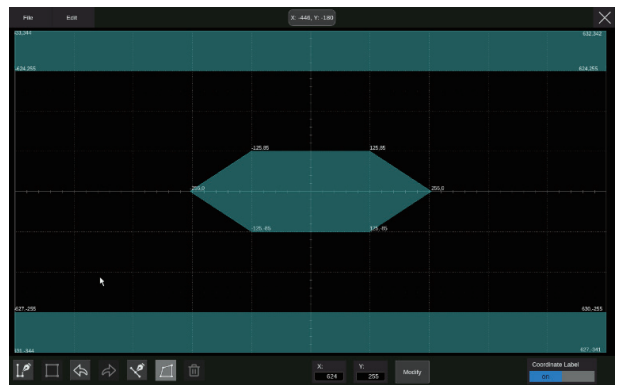

Built-in Mask Editor application helps to create custom masks

## • Power Analysis (Optional)

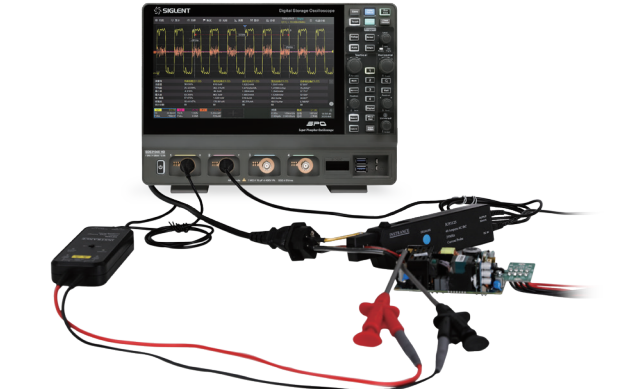

The Power Analysis option provides a full suite of power measurements and analysis, which greatly improve the measurement efficiency in switching power supplies and power devices design

## • Digital Channels / MSO (Optional)



Four analog channels plus 16 digital channels enable users to acquire and trigger the waveforms then analyze the pattern, simultaneously with one instrument

## • 50 MHz Function/Arbitrary Waveform Generator (Optional)



The oscilloscope can control the SAG1021I waveform generator to output a waveform with up to 50 MHz frequency and  $\pm 3$  V amplitude. Six basic waveforms plus multiple types of arbitrary waveforms are built-in

## Specifications

Model	SDS3104X HD	SDS3054X HD	SDS3034X HD
Analog channels	4 + EXT		
Bandwidth	1 GHz (800 MHz in non-interleaving mode)	500 MHz	350 MHz
Sample rate (Max.)	4 GSa/s (interleaving mode), 2 GSa/s (non-interleaving mode)		
Memory depth (Max.)	400 Mpts/ch (interleaving mode: single-channel), 200 Mpts/ch (interleaving mode: dual-channel), 100 Mpts/ch (non-interleaving mode)		
Waveform capture rate (Max.)	Normal mode: 200,000 wfm/s; Sequence mode: 890,000 wfm/s		
Vertical resolution	12-bit. Up to 16-bit in ERES mode		
Trigger type	Edge, Slope, Pulse width, Window, Runt, Interval, Dropout, Pattern, Video, Qualified, Nth edge, Setup/hold, Delay, Serial		
Serial trigger and decode	Standard: I2C, SPI, UART, CAN, LIN Optional: CAN FD, FlexRay, I2S, MIL-STD-1553B, SENT, Manchester (decode only), ARINC429		
Measurement	50+ parameters, statistics, histogram, trend, and track supported		
Math	4 traces 4 Mpts FFT, +, -, x, $\div$ , $\int$ dt, $d/dt$ , $\sqrt{\quad}$ , Identity, Negation, Absolute, Sign, ex, 10x, ln, lg, Interpolation, MaxHold, MinHold, ERES, Average, Filter. Supports formula editor		
Data analysis	Search, Navigate, History, Mask Test, Digital Voltmeter, Counter, Waveform Histogram, Bode plot, and Power Analysis		
Digital channel (optional)	16-channel; maximum sample rate up to 1 GSa/s; record length up to 100 Mpts		
Waveform generator (optional)	Single-channel SAG1021I, frequency up to 50 MHz, 125 MSa/s sample rate, 16 kpts waveform memory		
I/O	USB 3.0 Host x2, USB 2.0 Host x1, USB 3.0 Device, 10M/100M/1000M LAN, External trigger, Auxiliary output (TRIG OUT, PASS/FAIL)		
Probe (Standard)	One 500 MHz passive probe supplied for each channel		
Display	10.1 TFT-LCD with capacitive touch screen (1024*600)		

## Ordering Information

Model	Description
SDS3104X HD	1 GHz, 4 GSa/s, 4-CH, 12-bit, 400 Mpts/ch memory depth, 10.1" capacitive touch screen
SDS3054X HD	500 MHz, 4 GSa/s, 4-CH, 12-bit, 400 Mpts/ch memory depth, 10.1" capacitive touch screen
SDS3034X HD	350 MHz, 4 GSa/s, 4-CH, 12-bit, 400 Mpts/ch memory depth, 10.1" capacitive touch screen
Standard Accessories	Quantity
USB cable	1
Quick start	1
Passive probe (500 MHz)	1/channel
Certificate of calibration	1
Wireless mouse	1
Power cord	1
Optional Accessories	Part No.
USB isolated waveform generator	SAG1021I
16-channel logic probe	SPL2016
Power Analysis deskew fixture	DF2001A
STB3 demo signal source	STB3
USB-GPIB adapter	USB-GPIB
High-speed active probe	SAP1000, SAP2500
High voltage probe	HPB4010
High-speed differential probe	SAP2500D
High voltage differential probe	DPB1300/DPB4080/DPB5150/ DPB5150A/DPB5700/DPB5700A
Current probe	CPL5100/CP4020/CP4050/CP4070/CP4070A CP6030/CP6030A/CP6150/CP6500/SCP5030/SCP5030A/SCP5150/SCP5150A
Bag	BAG-S2
Options	Part No.
Waveform generator (software)	SDS3000HD-FG
16 digital channels (software)	SDS3000HD-16LA
Power Analysis (software)	SDS3000HD-PA
I2S trigger & decode (software)	SDS3000HD-I2S
MIL-STD-1553B trigger & decode (software)	SDS3000HD-1553B
FlexRay trigger & decode (software)	SDS3000HD-FlexRay
CAN FD trigger & decode (software)	SDS3000HD-CANFD
SENT trigger & decode (software)	SDS3000HD-SENT
Manchester decode (software)	SDS3000HD-Manch
ARINC429 trigger & decode (software)	SDS3000HD-ARINC
350 MHz to 500 MHz bandwidth upgrade (software)	SDS3000HD-BW3T5
350 MHz to 1 GHz bandwidth upgrade (software)	SDS3000HD-BW3TA
500 MHz to 1 GHz bandwidth upgrade (software)	SDS3000HD-BW5TA



## SDS2000X HD Super Phosphor Oscilloscope

### Key Features

- 12-bit High Resolution
  - 12-bit Analog-Digital Convertors with sample rate up to 2 GSa/s
  - Front ends with 70  $\mu$ Vrms noise floor @ 500 MHz bandwidth and 0.5% DC gain accuracy
- 4 analog channels, up to 350 MHz bandwidth (upgradable to 500 MHz)
- SPO technology
  - Waveform capture rate up to 100,000 wfm/s (normal mode), and 500,000 wfm/s (sequence mode)
  - Supports 256-level intensity grading and color temperature display modes
  - Up to 200 Mpts/ch record length
  - Digital trigger system
- Intelligent trigger: Edge, Slope, Pulse, Window, Runt, Interval, Dropout, Pattern, Qualified, Nth edge, Setup/hold, Delay and Video (HDTV supported). Zone Trigger simplifies advanced triggering
- Serial bus triggering and decoder, supports protocols I2C, SPI, UART, CAN, LIN, CAN FD, FlexRay, I2S, MIL-STD-1553B, SENT and Manchester
- Segmented acquisition (Sequence) mode, dividing the maximum record length into multiple segments (up to 80,000), according to trigger conditions set by the user, with a very small dead time between segments to capture the qualifying event
- History waveform record (History) function, the maximum recorded waveform length is 80,000 frames
- Automatic measurements on 50+ parameters, supports statistics with histogram, track, trend, Gating measurement, and measurements on Math, History and Ref
- 2 Math traces (2 Mpts FFT, addition, subtraction, multiplication, division, integration, differential, square root, etc.), supports formula editor
- Abundant data analysis functions such as Search, Navigate, Digital Voltmeter, Counter, Waveform Histogram, Bode plot and Power Analysis
- High Speed hardware-based Average, ERES; High Speed hardware-based Mask Test function, with Mask Editor tool for creating user-defined masks
- 16 digital channels (optional)
- Built-in 25 MHz waveform generator
- Large 10.1" TFT-LCD display with 1024 \* 600 resolution; Capacitive touch screen supports multi-touch gestures
- Interfaces include: USB Hosts, USB Device (USBTMC), LAN (VXI-11/Telnet/Socket), Pass/Fail, Trigger Out
- Built-in web server supports remote control over the LAN port using a web browser. Supports SCPI remote control commands. Supports external mouse and keyboard

## Characteristics

### • 12-bit High Resolution

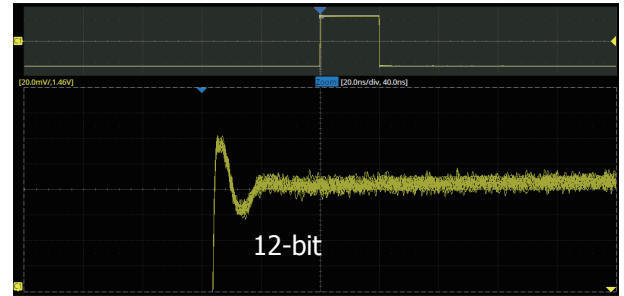
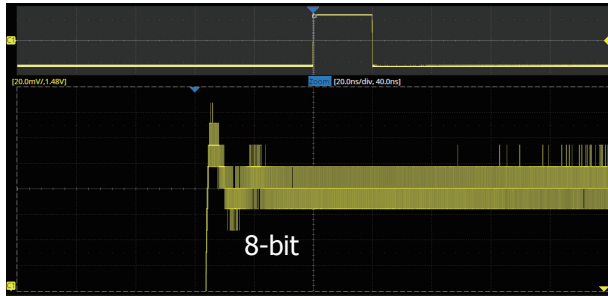

12-bit resolution shows you more details and less noise on the waveform

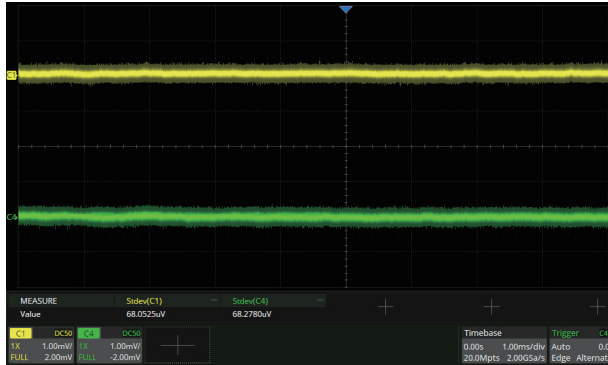

Low noise floor: Only 70  $\mu$ Vrms at 500 MHz bandwidth

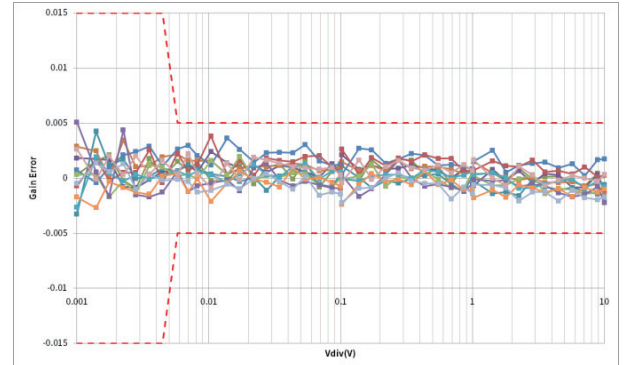

0.5% DC gain accuracy

### • Excellent User Interface and User Experience



- 10.1" display with 1024x600 resolution
- Capacitive touch screen, supporting multi-touch gestures, can move or scale the waveform traces quickly by finger-touch movements, which greatly improves the operation efficiency
- Built-in WebServer supports remote control on a web page over LAN
- Supports external mouse and keyboard

### • High Waveform Update Rate

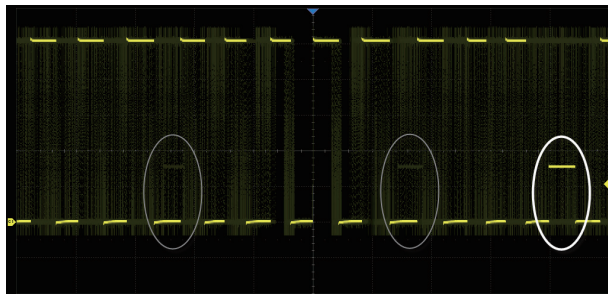

With a waveform update rate of up to 100,000 wfms/s, the oscilloscope can easily capture unusual or low-probability events. In Sequence mode, the waveform capture rate can reach 500,000 wfms/s

### • Deep Record Length

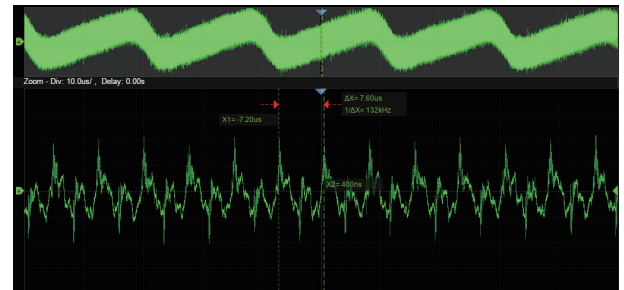

Using hardware-based Zoom technique and record length of up to 200 Mpts, users can select a slower timebase without compromising the sample rate, and then quickly zoom in to focus on the area of interest

## Multiple Trigger Functions

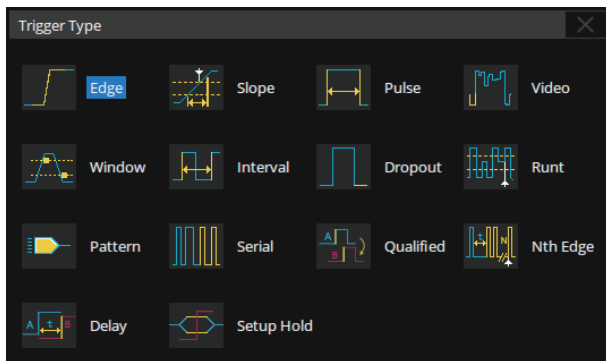

Edge, Slope, Pulse, Video, Windows, Runt, Interval, Dropout, Pattern, Qualified, Nth edge, Setup/hold, Delay, and serial trigger

## Advanced Math Function

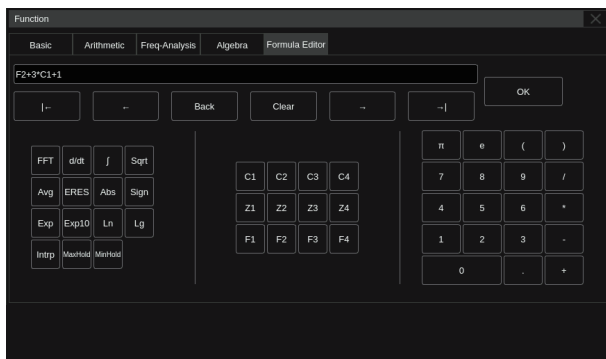

In addition to the traditional (+, -, X, /) operations, FFT, integration, differential, square root, and more are supported. Formula Editor is available for more complex operations. 2 math traces are available

## Trigger Zone



Trigger Zone is available for advanced triggering

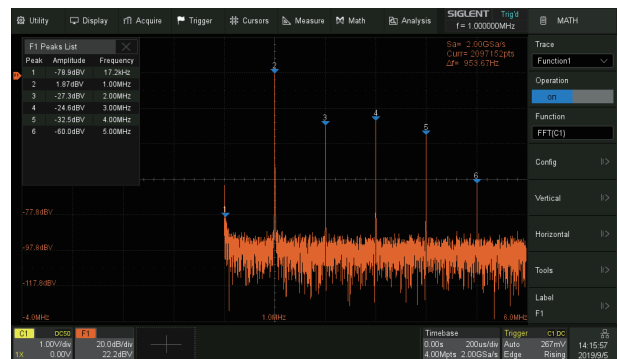

Hardware-accelerated FFT supports up to 2 Mpts operation. This provides high-frequency resolution with a fast refresh rate. The FFT function also supports a variety of window functions so that it can adapt to different spectrum measurement needs. Three modes (Normal, Average, and Max hold) can satisfy different requirements for observing the power spectrum. Auto peak detection and markers are supported

## History Mode

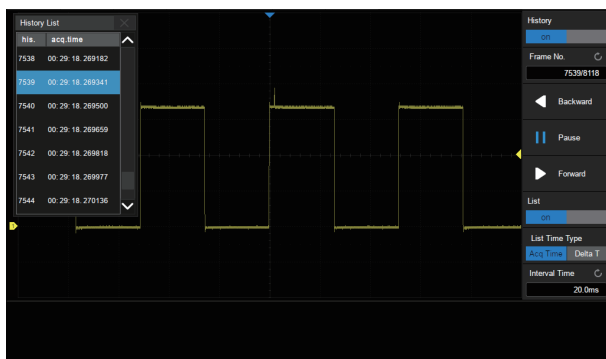

History function can record up to 80,000 frames of waveforms. The recording is executed automatically so that the customer can playback the history waveforms at any time to observe unusual events and quickly locate the area of interest using the cursors or measurements. The failed frames of the Mask Test can be stored as history

## Sequence Mode

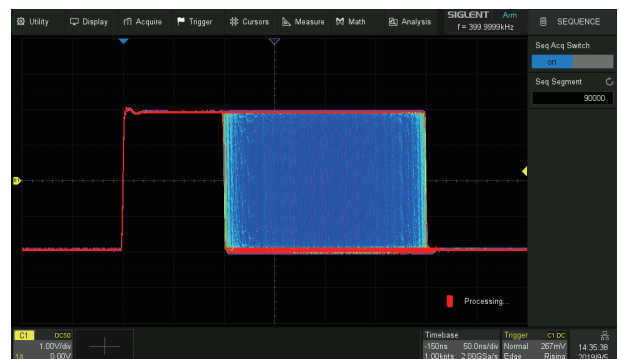

Segmented memory collection will store the waveform into multiple memory segments (up to 80,000) and each segment will store a triggered waveform as well the dead time information. The interval between segments can be as small as 2 μs. All of the segments can be played back using the History function



## • Search and Navigate



The oscilloscope can search events specified by the user in a frame. Events flagged by the Search can be recalled automatically using Navigate. It can also navigate by time (delay position) and history frames

## • Hardware-based High-Speed Mask Test Function

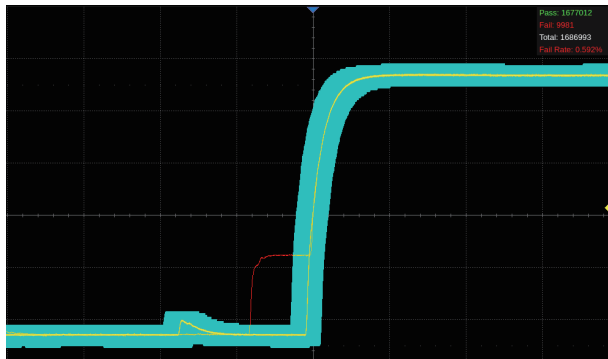

The oscilloscope utilizes a hardware-based Mask Test function, performing up to 14,000 Pass / Fail decisions each second. It is easy to generate user-defined test templates to provide trace mask comparisons, making it suitable for long-term signal monitoring or automated production line testing

## • Bode Plot



The oscilloscope can control the built-in waveform generator or a stand-alone SIGLENT generator, to scan the amplitude and phase-frequency response of the DUT, and display the data as a Bode Plot. This makes it possible to replace expensive network analyzers in some applications

## • Serial Bus Decode



Display the decoded characters through the events list. Bus protocol information can be quickly and intuitively displayed in tabular form. I2C, SPI, UART, CAN, LIN, CAN FD, FlexRay, I2S, MIL-STD-1553B, SENT, and Manchester are supported

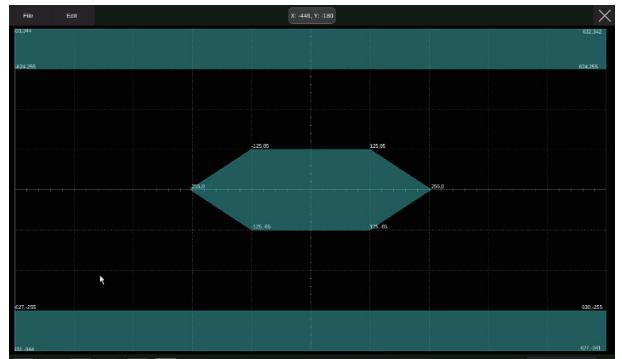

Built-in Mask Editor application helps to create custom masks

## • Power Analysis (Optional)



The Power Analysis option provides a full suite of power measurements and analysis, which greatly improve the measurement efficiency in switching power supplies and power devices design

## • Digital Channels / MSO (Optional)



Four analog channels plus 16 digital channels enable users to acquire and trigger the waveforms then analyze the pattern, simultaneously with one instrument

## • Built-in 25 MHz Waveform Generator (Optional)

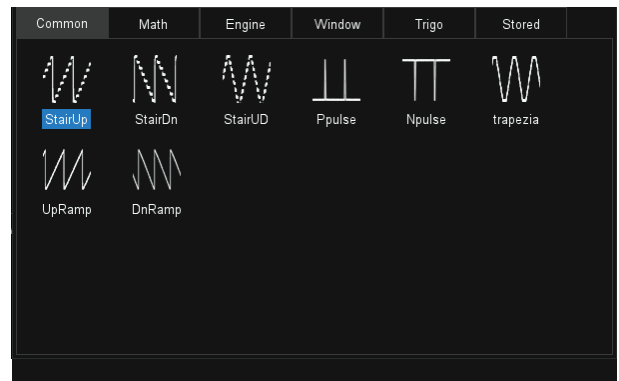

The built-in waveform generator can output waveforms with up to 25 MHz frequency and  $\pm 3$  V amplitude. Six basic waveforms together with multiple types of predefined waveforms and as user-defined arbitrary waveforms are supported

## • Complete Connectivity

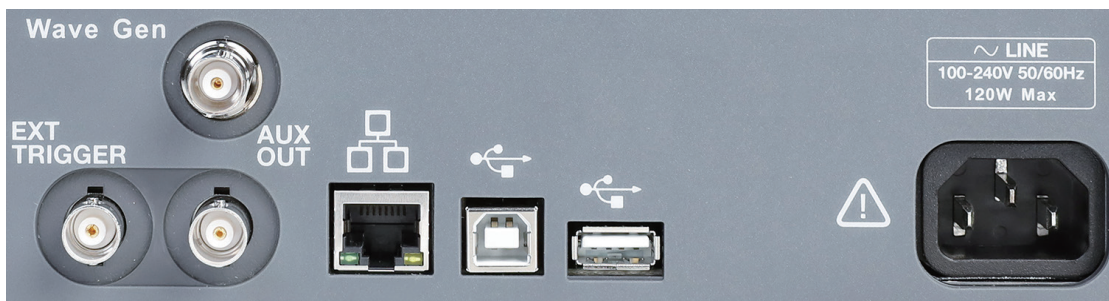

USB Host 2.0 x3, USB Device 2.0 (USBTMC), LAN (VXI-11/Telnet/Socket), Auxiliary output (Pass/Fail, Trigger Out), etc

## Specifications

Model	SDS2354X HD	SDS2204X HD	SDS2104X HD
Analog channels	4 + EXT		
Bandwidth	350 MHz, (upgradable to 500 MHz)	200 MHz	100 MHz
Vertical resolution	12-bit		
Sample rate (Max.)	2 GSa/s (interleaving mode), 1 GSa/s (non-interleaving mode)		
Memory depth (Max.)	200 Mpts/ch (interleaving mode), 100 Mpts/ch (non-interleaving mode)		
Waveform capture rate (Max.)	Normal mode: 100,000 wfm/s; Sequence mode: 500,000 wfm/s		
Trigger type	Edge, Slope, Pulse width, Window, Runt, Interval, Dropout, Pattern, Video, Qualified, Nth edge, Setup/hold, Delay, Serial		
Serial trigger and decode	Standard: I2C, SPI, UART, CAN, LIN Optional: CAN FD, FlexRay, I2S, MIL-STD-1553B, SENT, Manchester (decode only)		
Measurement	50+ parameters, statistics, histogram, trend, and track supported		
Math	2 traces 2 Mpts FFT, +, -, x, ÷, ∫dt, d/dt, √, Identity, Negation, Absolute, Sign, ex, 10x, ln, lg, Interpolation, MaxHold, MinHold, ERES, Average. Supports formula editor		
Data analysis	Search, Navigate, History, Mask Test, Digital Voltmeter, Counter, Waveform Histogram, Bode plot, and Power Analysis		
Digital channel (optional)	16-channel; maximum sample rate up to 500 MSa/s; record length up to 50 Mpts		
Waveform generator (optional)	Single-channel built-in waveform generator, frequency up to 25 MHz, 125 MSa/s sample rate, 16 kpts waveform memory		
I/O	USB 2.0 Host x3, USB 2.0 Device, 10 M / 100 M LAN, External trigger, Auxiliary output (TRIG OUT, PASS/FAIL)		
Probe (Standard)	One 500 MHz passive probe supplied for each channel		
Display	10.1 TFT-LCD with capacitive touch screen (1024*600)		

## Ordering Information

Model	Description
SDS2354X HD	12-bit, 350 MHz, 2 GSa/s, 4-CH, 200 Mpts/ch memory depth, 10.1" capacitive touch screen
SDS2204X HD	12-bit, 200 MHz, 2 GSa/s, 4-CH, 200 Mpts/ch memory depth, 10.1" capacitive touch screen
SDS2104X HD	12-bit, 100 MHz, 2 GSa/s, 4-CH, 200 Mpts/ch memory depth, 10.1" capacitive touch screen
Standard Accessories	Quantity
USB cable	1
Quick start	1
Passive probe ( 500 MHz)	1/channel
Certificate of calibration	1
Wireless mouse	1
Power cord	1
Optional Accessories	Part No.
Waveform generator (software)	SDS2000HD-FG
16 digital channels (software)	SDS2000HD-16LA
16-channel logic probe	SPL2016
Power Analysis (software)	SDS2000HD-PA
Power Analysis deskew fixture	DF2001A
I2S trigger & decode (software)	SDS2000HD-I2S
MIL-STD-1553B trigger & decode (software)	SDS2000HD-1553B
FlexRay trigger & decode (software)	SDS2000HD-FlexRay
CAN FD trigger & decode (software)	SDS2000HD-CANFD
SENT trigger & decode (software)	SDS2000HD-SENT
Manchester decode (software)	SDS2000HD-Manch
100 MHz to 200 MHz bandwidth upgrade (software)	SDS2000HD-BW1T2
100 MHz to 350 MHz bandwidth upgrade (software)	SDS2000HD-BW1T3
100 MHz to 500 MHz bandwidth upgrade (software)	SDS2000HD-BW1T5
200 MHz to 350 MHz bandwidth upgrade (software)	SDS2000HD-BW2T3
200 MHz to 500 MHz bandwidth upgrade (software)	SDS2000HD-BW2T5
350 MHz to 500 MHz bandwidth upgrade (software)	SDS2000HD-BW3T5
STB3 demo signal source	STB3
High voltage probe	HPB4010
High voltage differential probe	DPB1300/DPB4080/DPB5150/DPB5150A/DPB5700/DPB5700A
Current probe	CPL5100/CP4020/CP4050/CP4070/CP4070A/CP6030/CP6030A/CP6150/CP6500
Bag	BAG-S2



## SDS2000X Plus Super Phosphor Oscilloscope

### Key Features

- 350 MHz, 200 MHz, 100 MHz models with real-time sample rate up to 2 GSa/s. A 500 MHz bandwidth upgrade option is available for 350 MHz models.
- SPO technology  
Waveform capture rates up to 120,000 wfms/s (normal mode) and 500,000 wfms/s (sequence mode)  
Supports 256-level intensity grading and color temperature display modes  
Record length up to 200 Mpts/ch, 400 Mpts in total for all 4 channels  
Digital trigger system
- 10-bit mode provides higher resolution and lower noise
- Segmented acquisition (Sequence) mode, dividing the maximum record length into multiple segments (up to 90,000), according to trigger conditions set by the user, with a very small dead time between segments to capture the qualifying event
- History waveform record (History) function for up to 90,000 triggered waveforms (frames)
- Automatic measurement function on 50+ parameters, supports statistics with histogram and trend
- Two Math traces, support 2 Mpts FFT, +, -, x, ÷, d/dt, ∫dt, √, average, ERES, and formula editor
- Abundant data processing and analysis functions such as Search, Navigate, Mask Test, Bode plot, Power Analysis (optional) and Counter
- 16 digital channels (optional)
- Built-in 50 MHz waveform generator (optional)
- Large 10.1" TFT-LCD display with 1024x600 resolution; Capacitive touch screen supports multi-touch gestures
- Multiple interfaces: USB Host, USB Device (USBTMC), LAN (VXI-11/Telnet/Socket), Pass/Fail, Trigger Out
- Built-in web server supports remote control by the LAN port using a web browser; Supports SCPI remote control commands

## Characteristics

### • Competitive Front End Performance

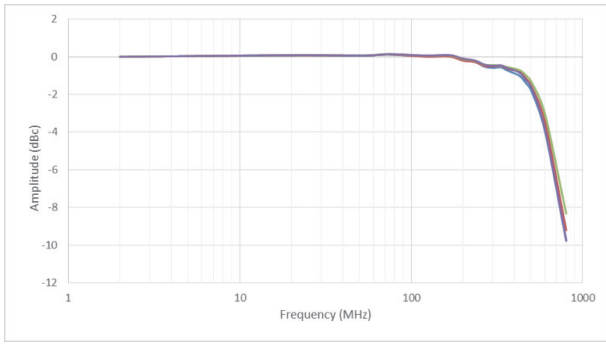

500 MHz bandwidth (at 2 GSa/s sample rate with 500 MHz bandwidth option).

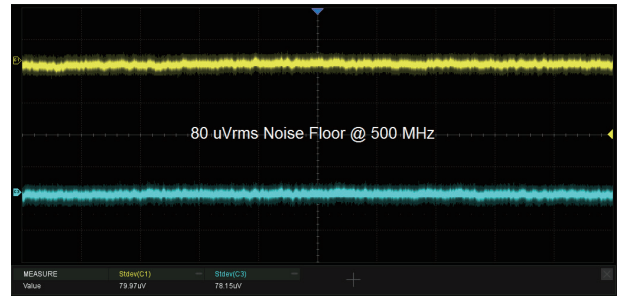

Low noise floor: Only 80  $\mu$ V rms at 500 MHz bandwidth.

### • 10-bit Mode

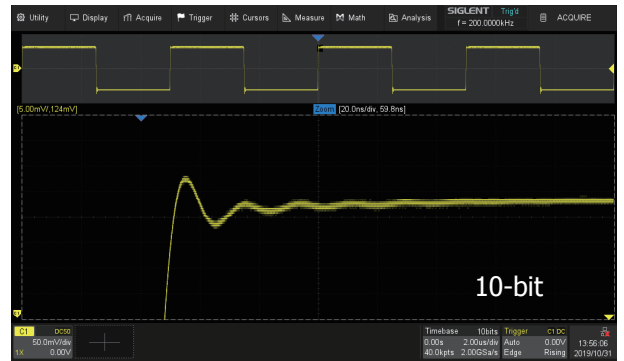
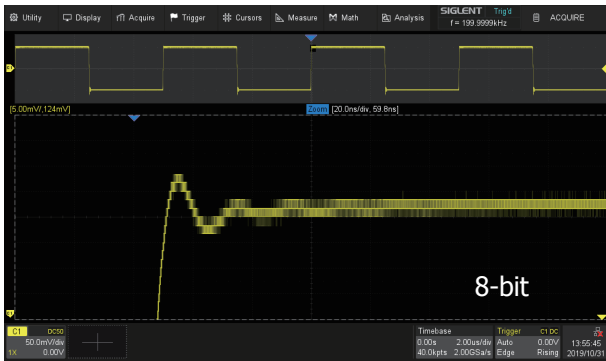

10-bit mode combined with Zoom shows you more details and less noise on the waveform.

### • Trigger Zone



Trigger Zone is available for advanced triggering.

### • Serial Bus Decode

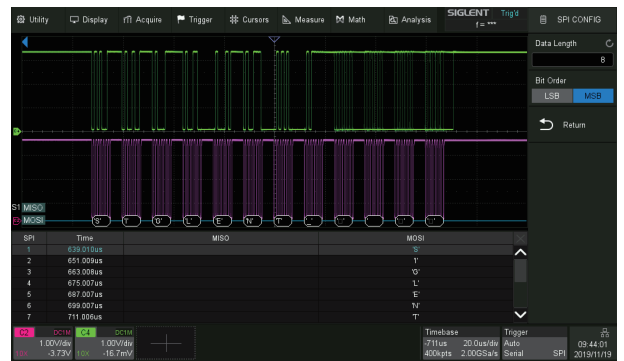

In addition to the decoder lanes correlated to the waveform, bus protocol information can be displayed in tabular form. I2C, SPI, UART, CAN, LIN, CAN FD, FlexRay, I2S and MIL-STD-1553B are supported.

## • Bode Plot



The SDS2000X Plus can control the built-in waveform generator or any stand-alone SIGLENT SDG device to scan the amplitude and phase response over frequency of passive or active circuits. The data is presented as Bode Plot. This makes it possible to replace expensive network analyzers in less demanding applications.

## • Digital Channels / MSO (Optional)



Four analog channels plus 16 digital channels allow the acquisition and triggering of mixed waveforms with one instrument.

## • Power Analysis (Optional)



The Power Analysis option provides a full suite of power measurements and analysis, thus improving the efficiency of measurement in switching power supplies and power device designs.

## • 50 MHz Built-in Waveform Generator (Optional)

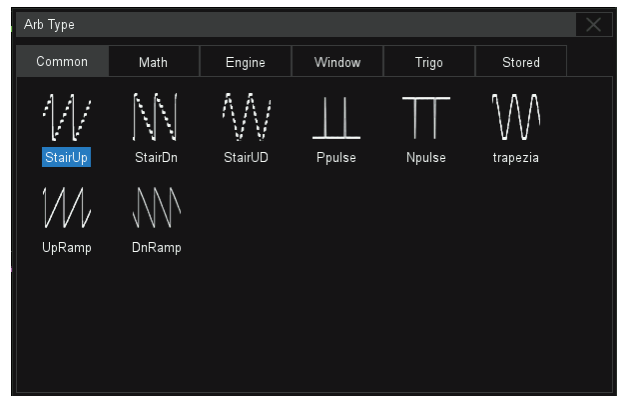

The built-in waveform generator can output waveforms with up to 50 MHz frequency and  $\pm 3$  V amplitude. Six basic waveforms together with multiple types of predefined waveforms and as user defined arbitrary waveforms are supported.

## Specifications

Model	SDS2354X Plus	SDS2204X Plus	SDS2104X Plus SDS2102X Plus
Analog channels	4 + EXT		2/4 + EXT
Bandwidth	350 MHz, (upgradable to 500 MHz)	200 MHz	100 MHz
Sample rate (Max.)	2 GSa/s (interleaving mode), 1 GSa/s (non-interleaving mode)		
Memory depth (Max.)	200 Mpts/ch (interleaving mode), 100 Mpts/ch (non-interleaving mode)		
Waveform capture rate (Max.)	Normal mode: 120,000 wfms/s; Sequence mode: 500,000 wfms/s		
Vertical resolution	8-bit. 10-bit mode (with typical 100 MHz bandwidth)		
Trigger type	Edge, Slope, Pulse, Window, Runt, Interval, Dropout, Pattern, Video and Serial		
Serial trigger and decode	Standard: I2C, SPI, UART, CAN, LIN Optional: CAN FD, FlexRay, I2S, MIL-STD-1553B		
Measurement	More than 50 parameters, supports statistics with histogram and trend		
Math	2 traces 2 Mpts FFT, +, -, x, ÷, d/dt, ∫dt, √, average, ERES, and formula editor		
Data processing and analysis tools	Search, Navigate, History, Mask test, Bode plot, Power Analysis (optional) and Counter		

Digital channel (optional)	16-channel; maximum sample rate up to 500 MSa/s; record length up to 50 Mpts/ch	
Waveform generator (optional)	Single channel, frequency up to 50 MHz, 125 MSa/s sample rate, 16 kpts waveform memory	
Interface	USB 2.0 Host x2, USB 2.0 Device, LAN, External trigger, Auxiliary output (TRIG OUT, PASS/FAIL)	
Probe (standard)	SP2035A, 350 MHz, 1 probe supplied for each channel	PP215, 200 MHz, 1 probe supplied for each channel
Display	10.1" TFT-LCD with capacitive touch screen (1024x600)	

## Ordering Information

Model	Description
SDS2354X Plus	350 MHz, 4-ch, 2 GSa/s (Max.), 200 Mpts, 10.1"touch screen
SDS2204X Plus	200 MHz, 4-ch, 2 GSa/s (Max.), 200 Mpts, 10.1"touch screen
SDS2104X Plus	100 MHz, 4-ch, 2 GSa/s (Max.), 200 Mpts, 10.1"touch screen
SDS2102X Plus	100 MHz, 2-ch, 2 GSa/s (Max.), 200 Mpts, 10.1"touch screen
Standard Accessories	Quantity
USB cable	1
Quick start	1
Passive probe	x2 (2-ch model); x4 (4-ch model)
Certificate of calibration	1
Power cord	1
Optional Accessories	Part Number
Waveform generator option (software)	SDS2000XP-FG
16 digital channels (software)	SDS2000XP-16LA
16-channel logic probe	SPL2016
Power Analysis (software)	SDS2000XP-PA
Power Analysis deskew fixture	DF2001A
I2S trigger & decode (software)	SDS2000XP-I2S
MIL-STD-1553B trigger & decode (software)	SDS2000XP-1553B
FlexRay trigger & decode (software)	SDS2000XP-FlexRay
CAN FD trigger & decode (software)	SDS2000XP-CANFD
100 MHz to 200 MHz bandwidth upgrade (4-ch model) (software)	SDS2000XP-4BW02
200 MHz to 350 MHz bandwidth upgrade (4-ch model) (software)	SDS2000XP-4BW03
350 MHz to 500 MHz bandwidth upgrade (4-ch model) (software)	SDS2000XP-4BW05
100 MHz to 350 MHz bandwidth upgrade (2-ch model) (software)	SDS2000XP-2BW03
STB3 demo signal source	STB3
High voltage probe	HPB4010
High voltage differential probe	DPB1300/DPB4080/DPB5150/DPB5150A/DPB5700/DPB5700A
Current probe	CPL5100/CP4020/CP4050/CP4070/CP4070A/CP5030/CP5030A/CP5150/CP5500
Bag	BAG-S2

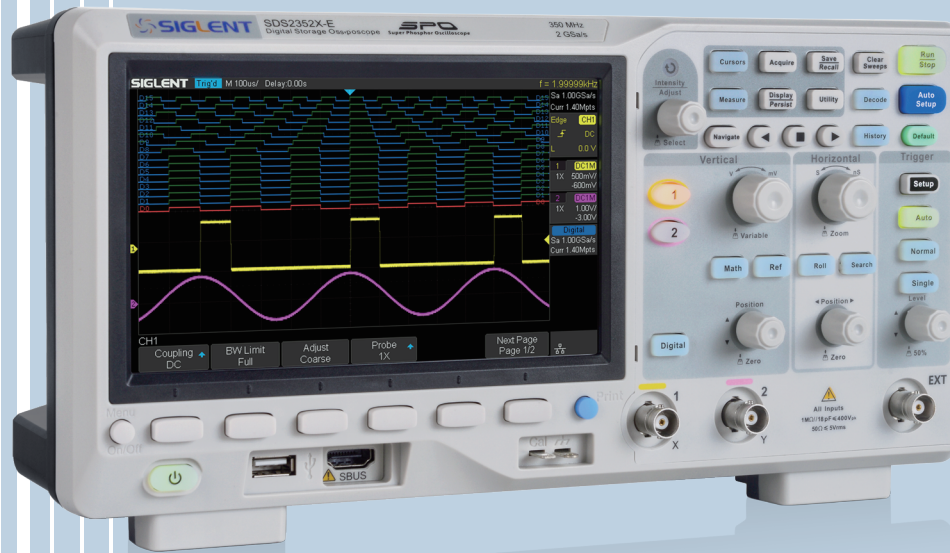

## SDS2000X-E Super Phosphor Oscilloscope

### Key Features

- 200 MHz, 350 MHz bandwidth models
- Real-time sampling rate up to 2 GSa/s (1 GSa/s per channel, if both channels active)
- Record length up to 28 Mpts
- Intelligent triggers: Edge, Slope, Pulse Width, Window, Runt, Interval, Time out (Dropout), Pattern
- Serial bus triggering and decoding (standard), supports protocols I<sup>2</sup>C, SPI, UART, CAN, LIN
- Low background noise with voltage scales from 500  $\mu$ V/div to 10 V/div
- 10 types of one-button shortcuts, supports Auto Setup, Default, Cursors, Measure, Roll, History, Display/Persist, Clear Sweep, Zoom and Print
- History waveform record (history) function (maximum recorded waveform length is 80,000 frames)
- 1 Mpts FFT
- Math and measurement functions use all sampled data points in memory (up to 28 Mpts)
- Math functions (FFT, addition, subtraction, multiplication, division, integration, differential, square root)
- Large 7 inch TFT -LCD display with 800 \* 480 resolution
- Supports Multi-language display and embedded online help



## Characteristics

- Maximum sample rate of 2 GSa/s, record Length of up to 28 Mpts



Using hardware-based Zoom technologies and max record length of up to 28 Mpts, users are able to oversample to capture for longer time periods at higher resolution and use the zoom feature to see more details within each signal.

- Serial Bus Decoding Function (Standard)

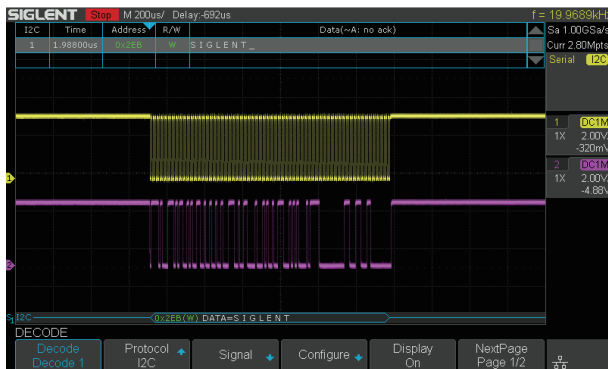

SDS2000X-E displays the decoding through the events list. Bus protocol information can be quickly and intuitively displayed in a tabular format.

- True measurement to 28 Mpts

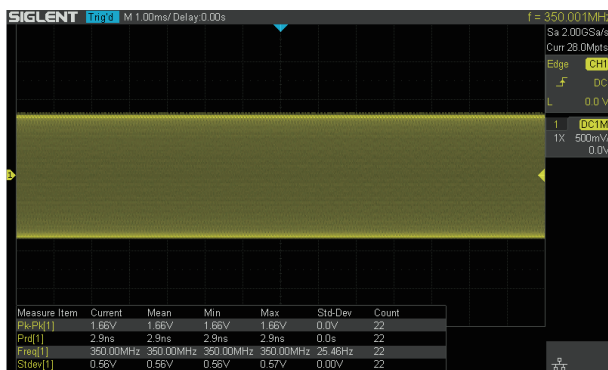

SDS2000X-E can apply automatic measurements on all sampled data points up to 28 Mpts. This ensures the accuracy of measurements while the math co-processor decreases measurement time and increases ease-of-use.

- Waveform Capture Rate up to 400,000 wfms/s



With a waveform capture rate of up to 400,000 wfms/s (sequence mode), the oscilloscope can easily capture the unusual or low-probability events.

- History Waveforms (History) Mode and Segmented Acquisition (Sequence)

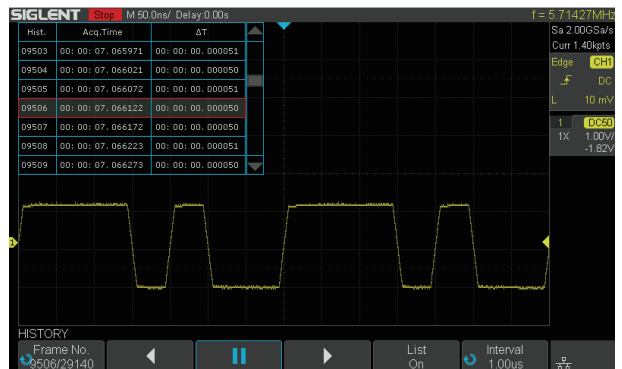

Playback the latest triggered events using the history function. Segmented memory collection will store trigger events into multiple (Up to 80,000) memory segments, each segment will store triggered waveforms and timestamp of each frame.

- 1 Mpts FFT

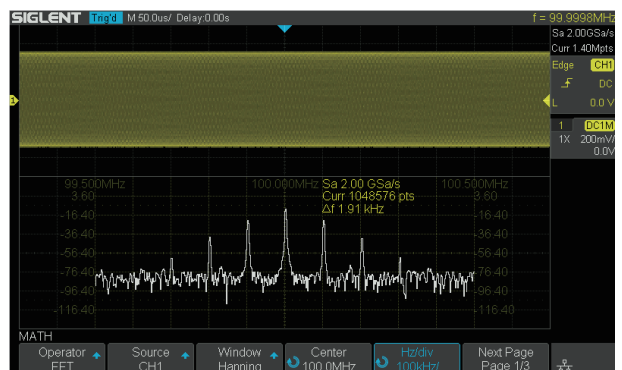

The new math co-processor enables FFT analysis of incoming signals using up to 1 million samples per waveform. This provides high frequency resolution with a fast refresh rate. The FFT function also supports a variety of window functions so that it can adapt to different spectrum measurement needs.

## • Hardware-Based High Speed Pass/Fail function

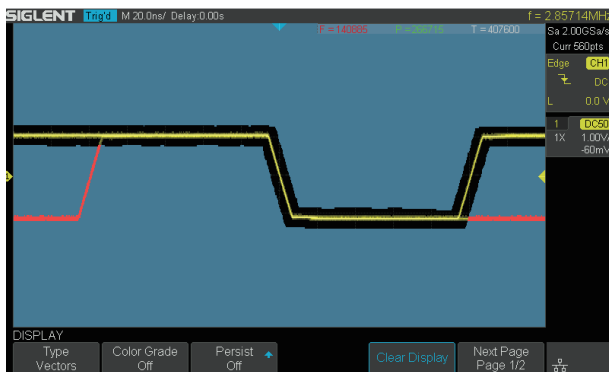

The SDS2000X-E utilizes a hardware-based Pass/Fail function, performing up to 40,000 Pass / Fail decisions each second. Easily generate user defined test templates provide trace mask comparison making it suitable for long-term signal monitoring or automated production line testing.

## • USB 25 MHz AWG Module (option)



The optional 25 MHz function/arbitrary waveform generator is operated from the USB host connection. Functions include Sine, Square, Ramp, Pulse, Noise, DC and 45 additional built-in waveforms. The arbitrary waveforms can be accessed and edited by the SIGLENT EasyWave PC software.

## • Bode Plot

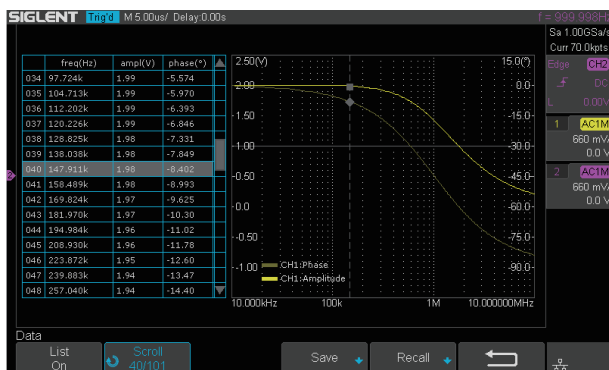

SDS2000X-E can control the USB AWG module or an independent SIGLENT SDG instrument, scan a circuits amplitude and phase frequency response, and display the data as a Bode Plot. It can also show the result lists, and export the data to a USB disk.

## • 16 Digital Channels/MSO (option)

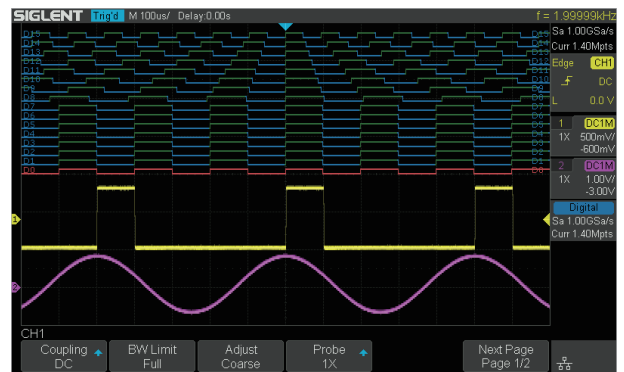

16 digital channels enables users to acquire and trigger on digital input channels and view both digital and analog waveforms simultaneously with one instrument.

## • Search and Navigate

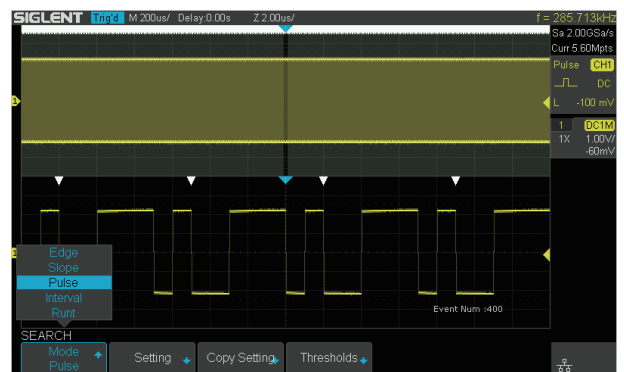

The SDS2000X-E can search events specified by the user in a frame. It can also navigate by time (delay position) and historical frames.

## • Web control

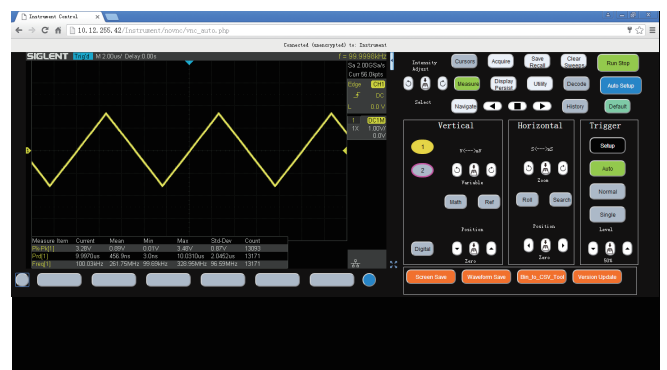

With the new embedded web server, users can control the SDS2000X-E from a simple web page. This provides wonderful remote troubleshooting and monitoring capabilities. The web page has PC and mobile styles that include an embedded virtual control panel.

## Models and key Specification

Model	SDS2202X-E	SDS2352X-E
Bandwidth	200 MHz	350 MHz
Sample Rate (Max.)	2 GSa/s	
Channels	2+EXT	
Memory Depth (Max.)	14 Mpts/CH (not interleave mode) 28 Mpts/CH (interleave mode)	
Waveform Capture Rate (Max.)	110,000 wfm/s (normal mode), 400,000 wfm/s (sequence mode)	
Trigger Type	Edge, Slope, Pulse Width, Window, Runt, Interval, Dropout, Pattern, Video	
Serial Trigger and decoder (Standard)	I <sup>2</sup> C, SPI, UART, CAN, LIN	
16 Digital Channels (option)	Maximum waveform capture rate up to 1GSa/s, Record length up to 14 Mpts/CH	
USB AWG module (option)	One channel, 25 MHz, sample rate of 125 MHz, 16 kpts waveform memory sample size	
Bode plot	Minimum start frequency of 10 Hz, minimum scan bandwidth of 500 Hz, maximum scan bandwidth of 120 MHz (dependent on Oscilloscope and AWG bandwidth), 500 maximum scan frequency points	
I/O	USB Host, USB Device, LAN, Pass/Fail, Trigger Out, Sbus (Siglent MSO)	
Probe (Std)	2 pcs passive probe PP215	2 pcs passive probe SP2035
Display	7 inch TFT-LCD (800 x 480 pixels)	
Weight	Without package 2.6 Kg; With package 3.8 Kg	

## Ordering Information

Product Name	SDS2000X-E Series Digital Oscilloscope	
	SDS2202X-E 200 MHz	
	SDS2352X-E 350 MHz	
Standard Accessories	USB Cable -1	
	Quick Start -1	
	Passive Probe -2	
	Certification of Calibration -1	
	Power Cord -1	
Optional Accessories	16 Channels MSO Software	SDS2000X-E-16LA
	16 Channels Logic Analyzer	SLA1016
	AWG Software	SDS2000X-E-FG
	USB AWG Module Hardware	SAG1021I
	STB Demo Source	STB-3
	High Voltage Probe	HPB4010
	Current Probes	CP4020/CP4050/CP4070/CP4070A/CP5030/CP5030A/CP5150/CP5500
	Differential Probes	DPB4080/DPB5150/DPB5150A/DPB5700/DPB5700A
Rack Mount	SDS1X-E-RMK	



## SDS1000X HD Super Phosphor Oscilloscope

### Key Features

- 12-bit High Resolution
  - 12-bit Analog-Digital Convertors with sample rate up to 2 GSa/s
  - Front ends with 70  $\mu$ Vrms noise floor @ 200 MHz bandwidth
- 2/4 analog channels, up to 200 MHz bandwidth
- SPO technology
  - Waveform capture rate up to 120,000 wfm/s (normal mode), and 500,000 wfm/s (sequence mode)
  - Supports 256-level intensity grading and color temperature display modes
  - Up to 100 Mpts record length
  - Digital trigger system
- Intelligent trigger: Edge, Slope, Pulse width, Window, Runt, Interval, Dropout, Pattern, Video (HDTV supported) , Qualified, Nth edge, Delay, Setup/Hold time.
- Serial bus triggering and decoder, supports protocols I2C, SPI, UART, CAN, LIN, CAN FD(decode only), FlexRay(decode only)
- Segmented acquisition (Sequence) mode, dividing the maximum record length into multiple segments (up to 80,000), according to trigger conditions set by the user, with a very small dead time between segments to capture the qualifying event
- History waveform record (History) function, the maximum recorded waveform length is 80,000 frames
- Automatic measurements on 50+ parameters, supports statistics with histogram, track, trend, Gating measurement, and measurements on Math, History and Ref
- 4 Math traces (2 Mpts FFT, addition, subtraction, multiplication, division, integration, differential, square root, etc.), supports formula editor
- Abundant data analysis functions such as Search, Navigate, Counter, Bode plot and Power Analysis
- High Speed hardware-based Mask Test function, with Mask Editor tool for creating user-defined masks
- 16 digital channels (optional)
- 25 MHz waveform generator(optional)
- Large 10.1" TFT-LCD display with 1024 \* 600 resolution; Capacitive touch screen supports multi-touch gestures
- Interfaces include: USB Hosts, USB Device (USBTMC), LAN (VXI-11/Telnet/Socket), Pass/Fail, Trigger Out
- Built-in web server supports remote control over the LAN port using a web browser. Supports SCPI remote control commands. Supports external mouse and keyboard

## Characteristics

### • 12-bit High Resolution

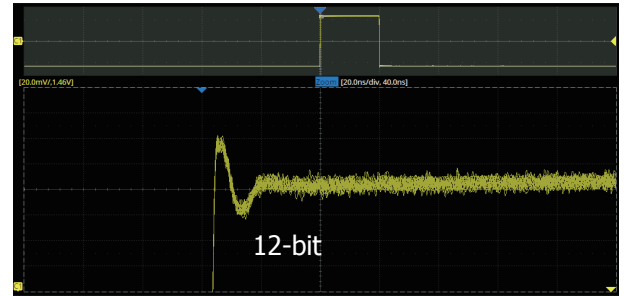
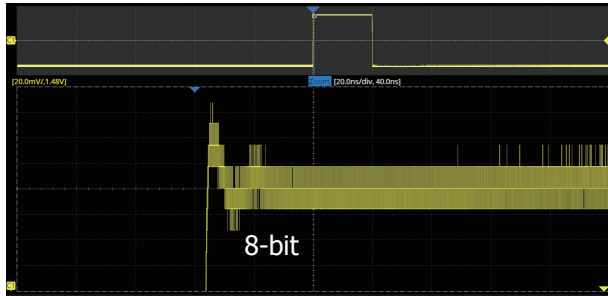

Vertical & Horizontal Zoom along with a large memory depth make the most out of 12-bit ADC resolution. Engineers can observe waveform overall and details simultaneously.

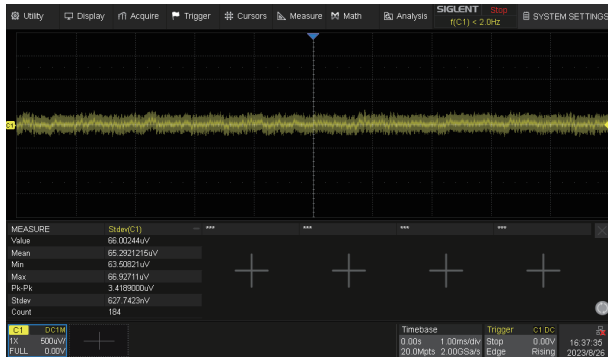

Low noise floor: Only 70  $\mu$ Vrms at 200 MHz bandwidth

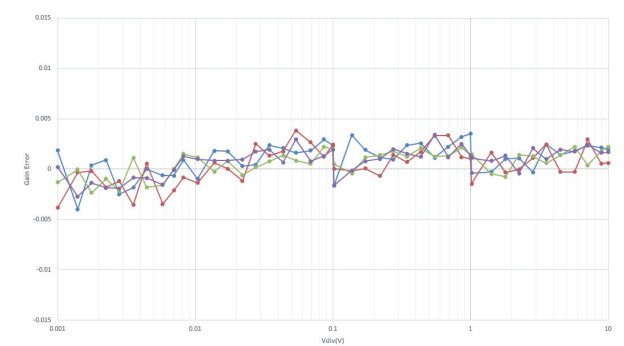

0.5% DC gain accuracy

### • Excellent User Interface and User Experience



- 10.1" display with 1024x600 resolution
- Capacitive touch screen, supporting multi-touch gestures, can move or scale the waveform traces quickly by finger-touch movements, which greatly improves the operation efficiency
- Built-in WebServer supports remote control on a web page over LAN
- Supports external mouse and keyboard

### • Serial Bus Decode

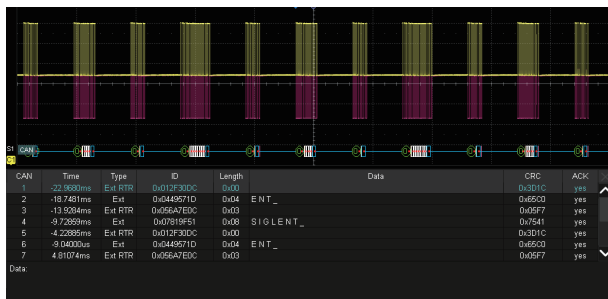

Display the decoded characters through the events list. Bus protocol information can be quickly and intuitively displayed in tabular form. I2C, SPI, UART, CAN, LIN, CAN FD, FlexRay are supported

### • Advanced Math Function

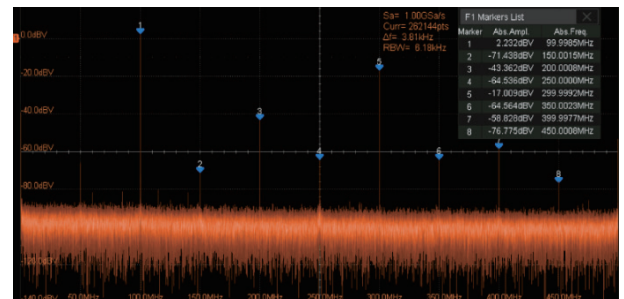

Hardware-accelerated FFT supports up to 2 Mpts operation. This provides high-frequency resolution with a fast refresh rate. The FFT function also supports a variety of window functions so that it can adapt to different spectrum measurement needs. Three modes (Normal, Average, and Max hold) can satisfy different requirements for observing the power spectrum. Auto peak detection and markers are supported.

## • Hardware-based High-Speed Mask Test Function

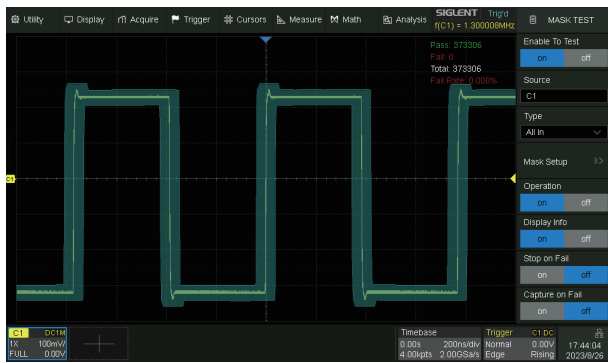

The oscilloscope utilizes a hardware-based Mask Test function, performing up to 80,000 Pass / Fail decisions each second. It is easy to generate user-defined test templates to provide trace mask comparisons, making it suitable for long-term signal monitoring or automated production line testing

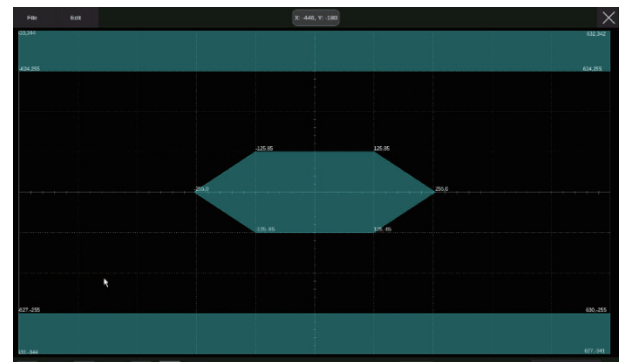

Built-in Mask Editor application helps to create custom masks

## • Digital Channels / MSO (Optional)

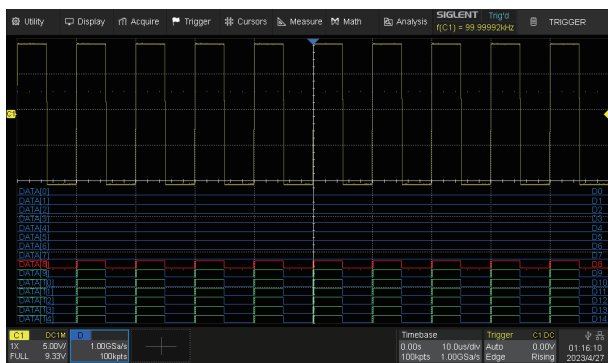

Four analog channels plus 16 digital channels enable users to acquire and trigger the waveforms then analyze the pattern, simultaneously with one instrument

## • USB AWG module (Optional)

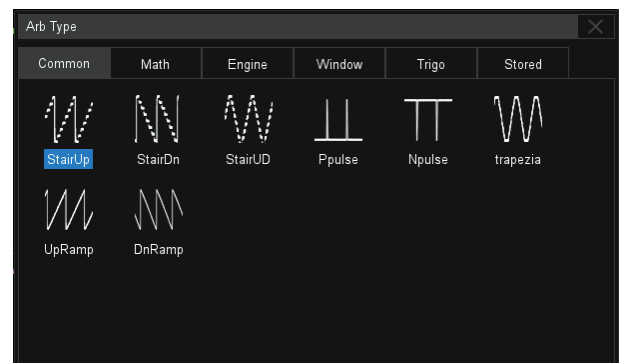

The USB waveform generator can output waveforms with up to 25 MHz frequency and  $\pm 3$  V amplitude. Six basic waveforms together with multiple types of predefined waveforms and as user-defined arbitrary waveforms are supported

## • Bode Plot

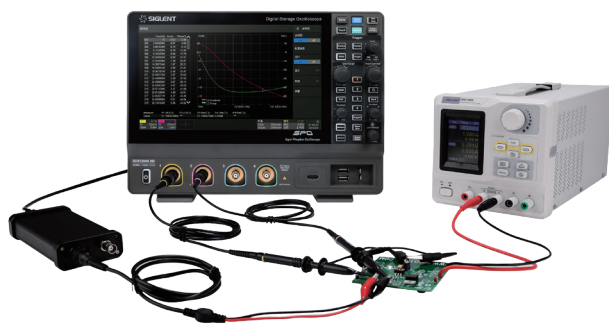

SDS1000X HD can control the USB AWG module or control an independent SIGLENT SDG instrument, scan a device's amplitude and phase frequency response, and display the data as a Bode Plot. There is also a Vari-level Mode for accurately measuring Power Supply Control Loop Response (PSRR)

## • Power Analysis (Optional)



The Power Analysis option provides a full suite of power measurements and analysis, which greatly improve the measurement efficiency in switching power supplies and power devices design

## Specifications

Model	SDS1104X HD SDS1102X HD	SDS1204X HD SDS1202X HD
Analog channels	4 + EXT (4CH Series: SDSxxx4X HD), 2 + EXT (2CH Series: SDSxxx2X HD)	
Bandwidth	100 MHz	200 MHz
Vertical resolution	12-bit	
Sample rate (Max.)	One channel mode: 2 GSa/s, Two channel mode: 1 GSa/s, Four channel mode: 500 MSa/s	
Memory depth (Max.)	One channel mode: 100 Mpts/ch, Two channel mode: 50 Mpts/ch, Four channel mode: 25 Mpts/ch	
Waveform capture rate (Max.)	Normal mode: 120,000 wfm/s; Sequence mode: 500,000 wfm/s	
Trigger type	Edge, Slope, Pulse width, Window, Runt, Interval, Dropout, Pattern, Video, Qualified, Nth edge, Delay, Setup/Hold time, Serial	
Serial trigger and decode(Standard)	I2C, SPI, UART, CAN, LIN, CAN FD (Decode Only), FlexRay (Decode Only)	
Measurement	50+ parameters, statistics, histogram, trend, and track supported	
Math	4 traces 2 Mpts FFT, Filter, +, -, x, ÷, ∫dt, d/dt, √, Identity, Negation, Absolute, Sign, ex, 10x, ln, lg, Interpolation, MaxHold, MinHold, ERES, Average. Supports formula editor	
Data analysis	Search, Navigate, History, Mask Test, Counter, Bode plot, and Power Analysis	
Digital channel (optional)	16-channel; maximum sample rate up to 1 GSa/s; record length up to 10 Mpts	
USB AWG module (option)	One channel, 25 MHz, sample rate of 125 MHz, wave length of 16 kpts, isolated output	
I/O	USB 2.0 Host x3, USB 2.0 Device, 10 M / 100 M LAN, External trigger, Auxiliary output (TRIG OUT, PASS/FAIL), SBUS (Siglent MSO)	
Probe (Standard)	Passive probe PP510 for each channel	Passive probe PP215 for each channel
Display	10.1 TFT-LCD with capacitive touch screen (1024*600)	

## Ordering Information

Model	Description
SDS1204X HD	200 MHz, 2 GSa/s, 4CH
SDS1104X HD	100 MHz, 2 GSa/s, 4CH
SDS1202X HD	200 MHz, 2 GSa/s, 2CH
SDS1102X HD	100 MHz, 2 GSa/s, 2CH
Standard Accessories	Quantity
USB cable	1
Quick start	1
Passive probe	1/channel
Certificate of calibration	1
Power cord	1
Optional Accessories	Part No.
AWG Software	SDS1000XHD-FG
USB Isolated AWG Module Hardware	SAG1021I
16 Channels MSO Software	SDS1000XHD-16LA
16 Channels Logic Analyzer	SLA1016
Power Analysis Software	SDS1000XHD-PA
Power Analysis deskew fixture	DF2001A



## SDS800X HD Super Phosphor Oscilloscope

### Key Features

- 12-bit High Resolution
  - 12-bit Analog-Digital Converters with sample rate up to 2 GSa/s
  - Front ends with 70  $\mu$ Vrms noise floor @ 200 MHz bandwidth
- 2/4 analog channels, up to 200 MHz bandwidth
- SPO technology
  - Waveform capture rate up to 120,000 wfm/s (normal mode), and 500,000 wfm/s (sequence mode)
  - Supports 256-level intensity grading and color temperature display modes
  - Up to 100 Mpts record length
  - Digital trigger system
- Intelligent trigger: Edge, Slope, Pulse width, Window, Runt, Interval, Dropout, Pattern, Video (HDTV supported), Qualified, Nth edge, Delay, Setup/Hold time.
- Serial bus triggering and decoder, supports protocols I2C, SPI, UART, CAN, LIN
- Segmented acquisition (Sequence) mode, dividing the maximum record length into multiple segments (up to 80,000), according to trigger conditions set by the user, with a very small dead time between segments to capture the qualifying event
- History waveform record (History) function, the maximum recorded waveform length is 80,000 frames
- Automatic measurements on 50+ parameters, supports statistics with histogram, track, trend, Gating measurement, and measurements on Math, History and Ref
- 4 Math traces (2 Mpts FFT, addition, subtraction, multiplication, division, integration, differential, square root, etc.), supports formula editor
- Abundant data analysis functions such as Search, Navigate, Counter, Bode plot and Power Analysis
- High Speed hardware-based Mask Test function, with Mask Editor tool for creating user-defined masks
- 16 digital channels (optional)
- 25 MHz waveform generator(optional)
- 7" TFT-LCD display with 1024 \* 600 resolution; Capacitive touch screen supports multi-touch gestures
- Interfaces include: USB Hosts, USB Device (USBTMC), LAN (VXI-11/Telnet/Socket), Pass/Fail, Trigger Out
- Built-in web server supports remote control over the LAN port using a web browser. Supports SCPI remote control commands. Supports external mouse and keyboard. Supports NTP



## Characteristics

### • 12-bit High Resolution

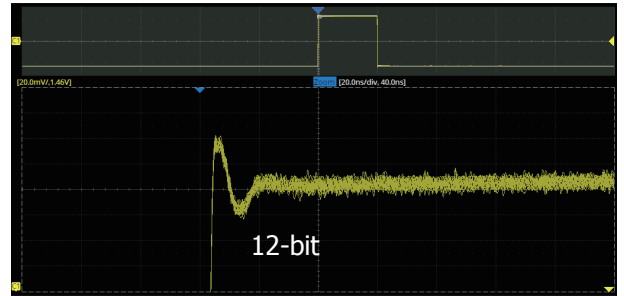
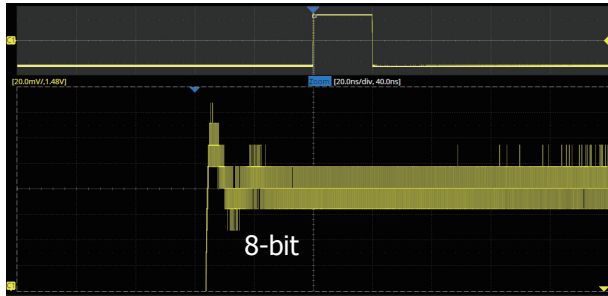

Vertical & Horizontal Zoom along with a large memory depth make the most out of 12-bit ADC resolution. Engineers can observe waveform overall and details simultaneously.

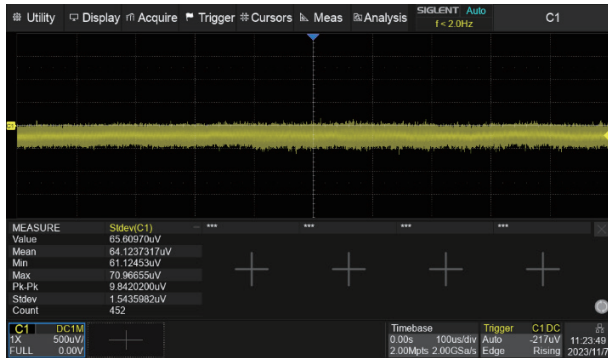

Low noise floor: Only 70  $\mu$ Vrms at 200 MHz bandwidth

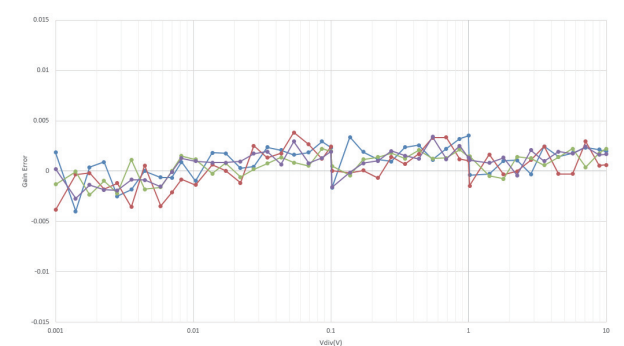

0.5% DC gain accuracy

### • Excellent User Interface and User Experience

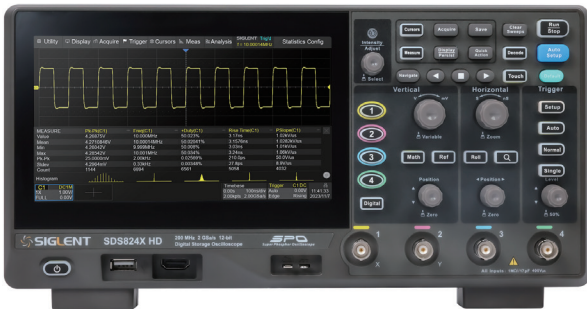

- 7" display with 1024x600 resolution
- Capacitive touch screen, supporting multi-touch gestures, can move or scale the waveform traces quickly by finger-touch movements, which greatly improves the operation efficiency
- Built-in WebServer supports remote control on a web page over LAN
- Supports external mouse and keyboard

### • History Mode

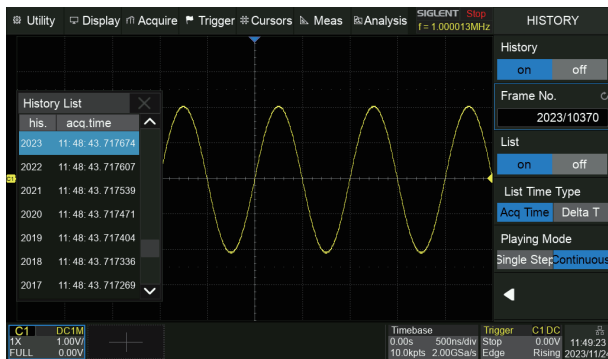

History function can record up to 80,000 frames of waveforms. The recording is executed automatically so that the customer can playback the history waveforms at any time to observe unusual events and quickly locate the area of interest using the cursors or measurements

### • Advanced Math Function

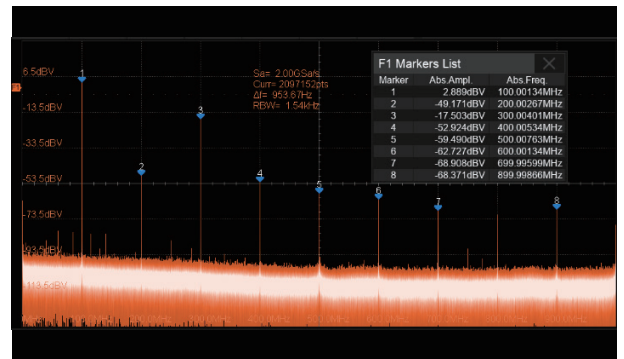

Hardware-accelerated FFT supports up to 2 Mpts operation. This provides high-frequency resolution with a fast refresh rate. The FFT function also supports a variety of window functions so that it can adapt to different spectrum measurement needs. Three modes (Normal, Average, and Max hold) can satisfy different requirements for observing the power spectrum. Auto peak detection and markers are supported

## ● Sequence Mode

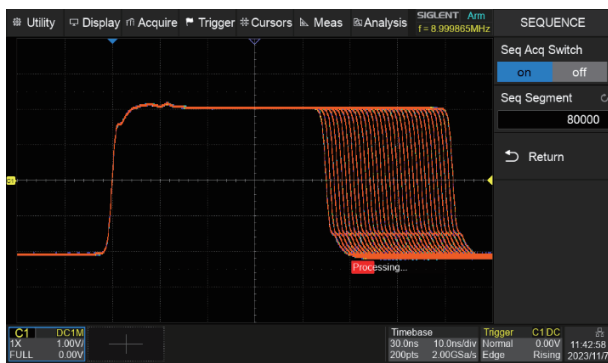

Segmented memory collection will store the waveform into multiple memory segments (up to 80,000) and each segment will store a triggered waveform as well the dead time information. The interval between segments can be as small as 2  $\mu$ s. All of the segments can be played back using the History function

## ● Hardware-based High-Speed Mask Test Function

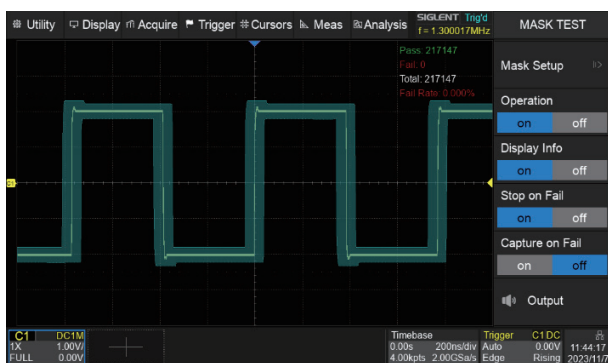

The oscilloscope utilizes a hardware-based Mask Test function, performing up to 80,000 Pass / Fail decisions each second. It is easy to generate user-defined test templates to provide trace mask comparisons, making it suitable for long-term signal monitoring or automated production line testing

## ● Bode Plot



SDS800X HD can control the USB AWG module or control an independent SIGLENT SDG instrument, scan a device's amplitude and phase frequency response, and display the data as a Bode Plot. There is also a Vari-level Mode for accurately measuring Power Supply Control Loop Response (PSRR)

## ● Serial Bus Decode

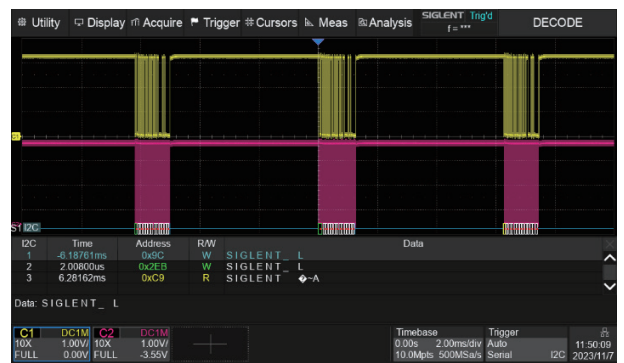

Display the decoded characters through the events list. Bus protocol information can be quickly and intuitively displayed in tabular form. I2C, SPI, UART, CAN, LIN are supported

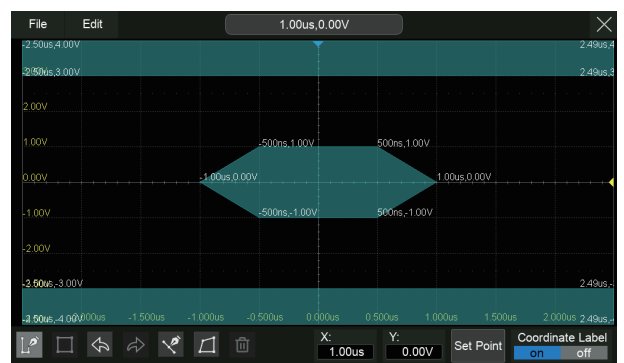

Built-in Mask Editor application helps to create custom masks

## ● Power Analysis (Optional)



The Power Analysis option provides a full suite of power measurements and analysis, which greatly improve the measurement efficiency in switching power supplies and power devices design

## • Digital Channels / MSO (Optional)

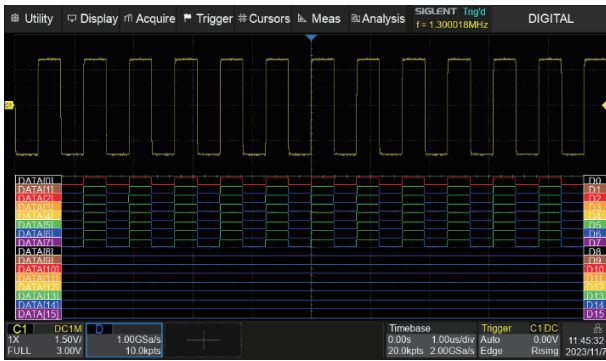

Four analog channels plus 16 digital channels enable users to acquire and trigger the waveforms then analyze the pattern, simultaneously with one instrument

## • USB AWG module (Optional)

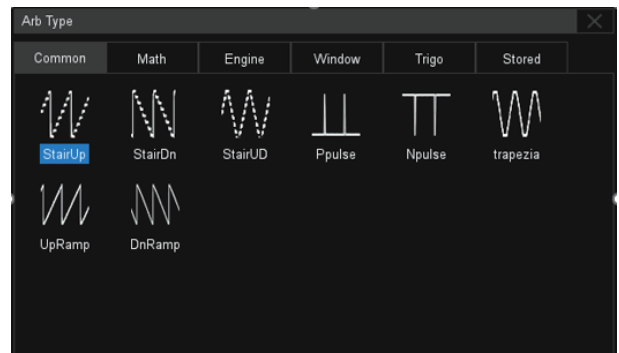

The USB waveform generator can output waveforms with up to 25 MHz frequency and  $\pm 3$  V amplitude. Six basic waveforms together with multiple types of predefined waveforms and as user-defined arbitrary waveforms are supported

## Specifications

Model	SDS804X HD SDS802X HD	SDS814X HD SDS812X HD	SDS824X HD SDS822X HD
Analog channels	4 (4CH Series: SDS804X HD, SDS814X HD, SDS824X HD), 2 (2CH Series: SDS802X HD, SDS812X HD, SDS822X HD)		
Bandwidth	70 MHz	100 MHz	200 MHz
Vertical resolution	12-bit		
Sample rate (Max.)	One channel mode: 2 GSa/s, Two channel mode: 1 GSa/s, Four channel mode: 500 MSa/s		
Memory depth (Max.)	One channel mode: 50 Mpts/ch, Two channel mode: 25 Mpts/ch, Four channel mode: 10 Mpts/ch		One channel mode: 100 Mpts/ch, Two channel mode: 50 Mpts/ch, Four channel mode: 25 Mpts/ch
Waveform capture rate (Max.)	Normal mode: 80,000 wfm/s; Sequence mode: 500,000 wfm/s		Normal mode: 120,000 wfm/s; Sequence mode: 500,000 wfm/s
Trigger type	Edge, Slope, Pulse width, Window, Runt, Interval, Dropout, Pattern, Video, Qualified, Nth edge, Delay, Setup/Hold time, Serial		
Serial trigger and decode(Standard)	I2C, SPI, UART, CAN, LIN		
Measurement	50+ parameters, statistics, histogram, trend, and track supported		
Math	4 traces 2 Mpts FFT, Filter, +, -, x, ÷, ∫dt, d/dt, √, Identity, Negation, Absolute, Sign, ex, 10x, ln, lg, Interpolation, MaxHold, MinHold, ERES, Average. Supports formula editor		
Data analysis	Search, Navigate, History, Mask Test, Counter, Bode plot, and Power Analysis		
Digital channel (optional)	16-channel; maximum sample rate up to 1 GSa/s; record length up to 10 Mpts		
USB AWG module (option)	One channel, 25 MHz, sample rate of 125 MHz, wave length of 16 kpts, isolated output		
I/O	USB 2.0 Host x2, USB 2.0 Device, 10 M / 100 M LAN, Auxiliary output (TRIG OUT, PASS/FAIL), SBUS (Siglent MSO)		
Probe (Standard)	Passive probe PB470 for each channel	Passive probe PP510 for each channel	Passive probe PP215 for each channel
Display	7 TFT-LCD with capacitive touch screen (1024*600)		

## Ordering Information

Model	Description
SDS824X HD	200 MHz, 2 GSa/s, 4CH
SDS814X HD	100 MHz, 2 GSa/s, 4CH
SDS804X HD	70 MHz, 2 GSa/s, 4CH
SDS822X HD	200 MHz, 2 GSa/s, 2CH
SDS812X HD	100 MHz, 2 GSa/s, 2CH
SDS802X HD	70 MHz, 2 GSa/s, 2CH

Standard Accessories	Quantity
USB cable	1
Quick start	1
Passive probe	1/channel
Certificate of calibration	1
Power cord	1

Optional Accessories	Part No.
AWG Software	SDS800XHD-FG
USB Isolated AWG Module Hardware	SAG1021I
16 Channels MSO Software	SDS800XHD-16LA
16 Channels Logic Analyzer	SLA1016
Power Analysis Software	SDS800XHD-PA
Power Analysis deskew fixture	DF2001A

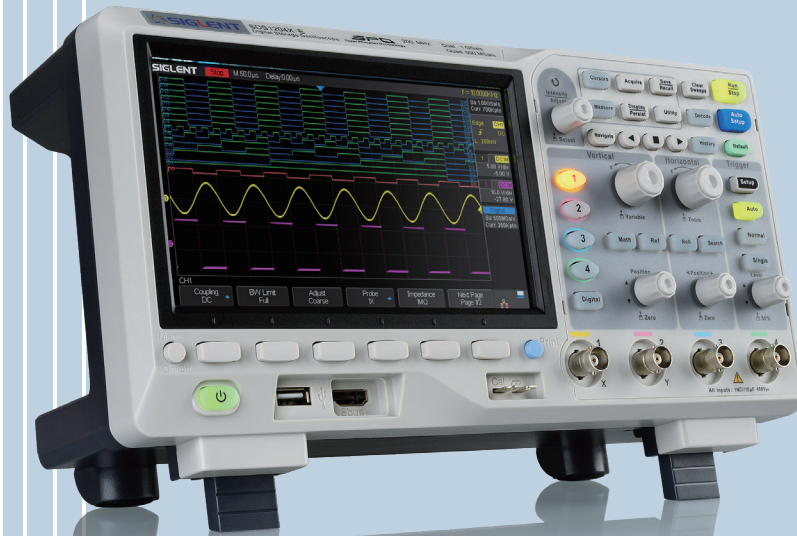

## SDS1000X-E Super Phosphor Oscilloscope

### Key Features

- Two channel series have one 1 GSa/s ADC, four channel series have two 1 GSa/s ADCs. When all channels are enabled, each channel has a maximum sample rate of 500 MSa/s. When a single channel per ADC is active, it has sample rate of 1 GSa/s
- The newest generation of SPO technology
  - Waveform capture rate up to 100,000 wfm/s (normal mode), and 400,000 wfm/s (sequence mode)
  - Supports 256-level intensity grading and color display modes
  - Record length up to 14 Mpts
  - Digital trigger system
- Intelligent trigger: Edge, Slope, Pulse Width, Window, Runt, Interval, Time out (Dropout), Pattern
- Serial bus triggering and decoding (Standard), supports protocols I<sup>2</sup>C, SPI, UART, RS232, CAN, LIN
- Segmented acquisition (Sequence) mode, divides the maximum record length into multiple segments (up to 80,000), according to trigger conditions set by the user, with a very small dead time segment to capture the qualifying event
- 1 Mpts FFT
- Math and measurement functions use all sampled data points (up to 14 Mpts)
- MSO, 16 digital channels (four channel series only, optional)
- Search and navigate (four channel series only)
- USB AWG module (four channel series only, optional)

## Function & Characteristics

- When all channels are enabled, each channel has a maximum sample rate of 500 MSa/s. When a single channel per pair is active, that channel has sample rate of 1 GSa/s

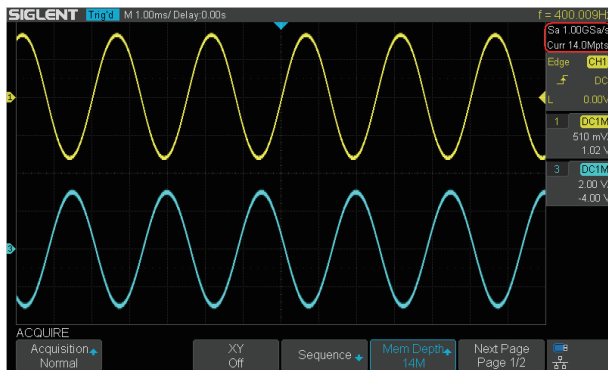

The four channel series has two 1 GSa/s ADC chips (channel 1 and 2 share one, channel 3 and 4 share another), so that each channel can achieve sample rates up to 500 MSa/s and work on bandwidths of 200 MHz when all channels are enabled.

- Record Length of Up to 14 Mpts (single channel/ pair mode), 7 Mpts/CH (two channels/pair mode)

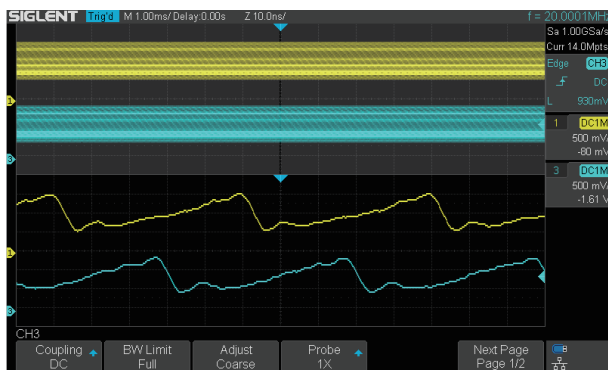

Using hardware-based Zoom technologies and max record length of up to 14 Mpts, users are able to oversample to capture for longer time periods at higher resolution and use the zoom feature to see more details within each signal.

- Waveform Capture Rate Up to 400,000 wfm/s

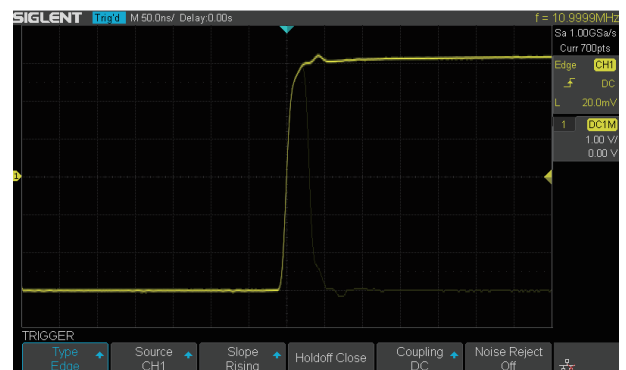

With a waveform capture rate of up to 400,000 wfm/s (sequence mode), the oscilloscope can easily capture the unusual or low-probability events.

- 256 -Level Intensity Grading and Color Temperature Display

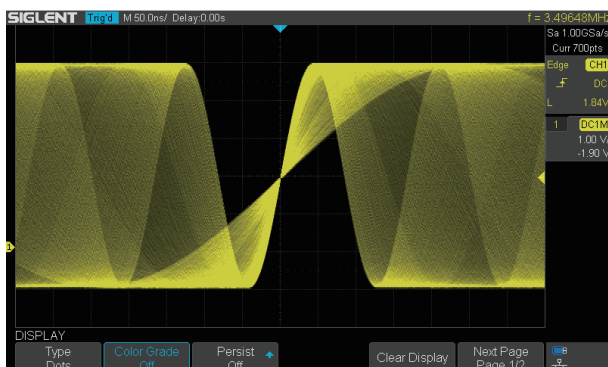

SPO display technology provides for fast refresh rates. The resulting intensity-graded trace is brighter for events that occur with more frequency and dims when the events occur with less frequency.

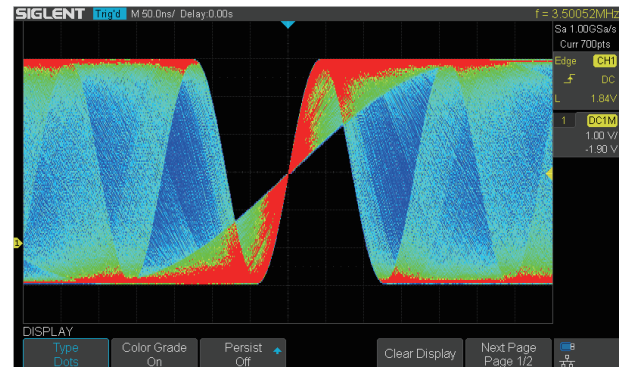

The color temperature display is similar to the intensity-graded trace function, but the trace occurrence is represented by different colors (color "temperature") as opposed to changes in the intensity of one color. Red colors represents the more frequent events, while blue is used to mark points that occur less frequently.

## • Search and Navigate (four channel series only)

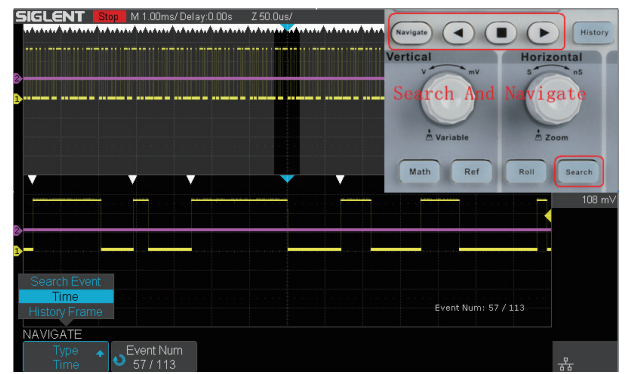
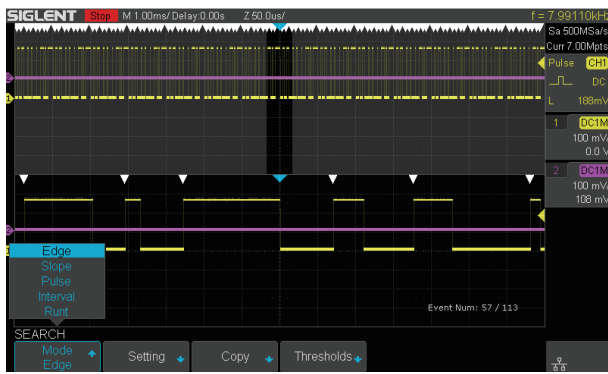

The SDS1000X-E can search events specified by the user in a frame. It can also navigate by time (delay position) and historical frames.

## • 16 Digital Channels/MSO (four channel series only, optional)

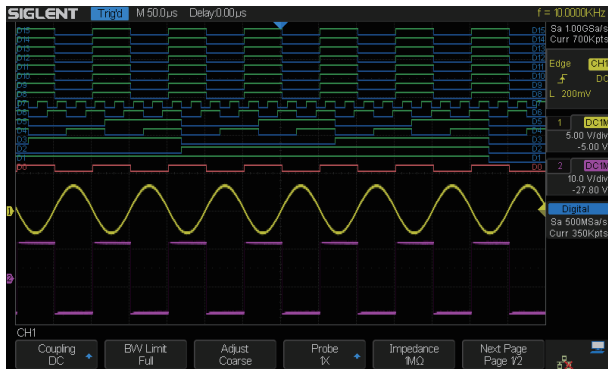

16 digital channels enables users to acquire and trigger on the waveforms then analyze the pattern, simultaneously with one instrument.

## • USB 25 MHz AWG Module (four channel series only, optional)



The four channel series supports a USB 25 MHz function/arbitrary waveform generator that is operated from the USB host connection. Functions include Sine, Square, Ramp, Pulse, Noise, DC and 45 built-in waveforms. The arbitrary waveforms can be accessed and edited by the SIGLENT EasyWave PC software.

## • 7 inch TFT-LCD display and 10 one-button menus

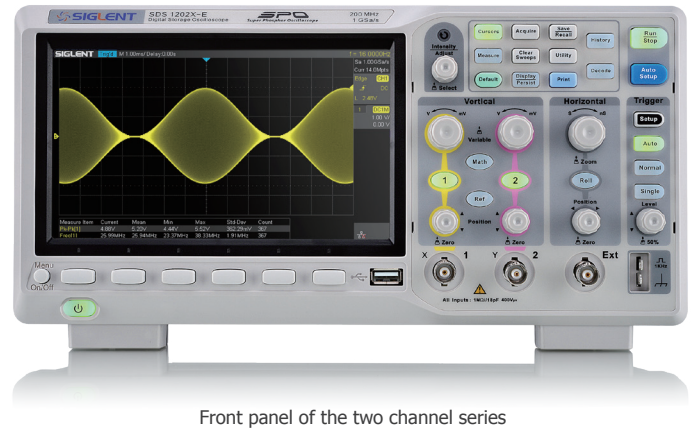
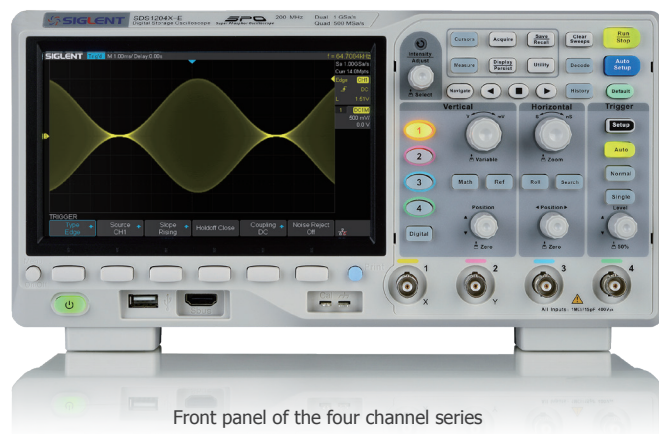

- 7-inch TFT -LCD display with 800 \* 480 resolution
- Most commonly used functions are accessible using 10 different one-button operation keys: Auto Setup, Default, Cursor, Measure, Roll, History, Persist, Clear Sweep, Zoom, Print

## Models and key Specification

Model	SDS1104X-E	SDS1204X -E SDS1202X-E
Bandwidth	100 MHz	200 MHz
Sampling Rate (Max.)	Two channel series have a single 1 GSa/s ADC, four channel series have two 1 GSa/s ADCs. When all channels are enabled, each channel has a maximum sample rate of 500 MSa/s. When a single channel per pair is active, that channel has sample rate of 1 GSa/s	
Channels	4 (four channel series) 2+EXT (two channel series)	
Memory Depth (Max.)	7 Mpts/CH (not interleave mode); 14 Mpts/CH (interleave mode)	
Waveform Capture Rate (Max.)	100,000 wfm/s (normal mode), 400,000 wfm/s (sequence mode)	
Trigger Type	Edge, Slope, Pulse Width, Window, Runt, Interval, Dropout, Pattern, Video	
Serial Trigger and decoder (Standard)	I <sup>2</sup> C, SPI, UART/RS232, CAN, LIN	
16 Digital Channels (four channel series only, optional)	Maximum waveform capture rate up to 1 GSa/s, Record length up to 14 Mpts/CH	
USB AWG module (four channel series only, optional)	One channel, 25 MHz, sample rate of 125 MHz, wave length of 16 kpts	
Bode plot ( four channel series only)	Minimum start frequency of 10 Hz, minimum scan bandwidth of 500 Hz, maximum scan bandwidth of 120 MHz (dependent on Oscilloscope and AWG bandwidth), 500 maximum scan frequency points	
I/O	USB Host, USB Device, LAN, Pass/Fail, Trigger Out, Sbus (Siglent MSO)	
Probe (Std)	4 pcs passive probe PP510	4/2 pcs passive probe PP215
Display	7 inch TFT -LCD (800x480)	
Weight	Four channel series: Without package 2.6 Kg; With package 3.8 Kg Two channel series: Without package 2.5 Kg; With package 3.5 Kg	

Ordering information		
Product Name	SDS1104X-E 100 MHz Four Channels	
	SDS1204X-E 200 MHz Four Channels	
	SDS1202X-E 200 MHz Two Channels	
Standard Accessories	USB Cable -1	
	Quick Start -1	
	Passive Probe -2/4	
	Certification -1	
	Power Cord -1	
Optional Accessories	16 Channels MSO Software (four channel series only)	SDS1000X-E-16LA
	16 Channels Logic Analyzer (four channel series only)	SLA1016
	AWG Software (four channel series only)	SDS1000X-E-FG
	USB AWG Module Hardware (four channel series only)	SAG1021I
	STB Demo Source	STB-3
	High Voltage Probe	HPB4010
	Current Probes	CP4020/CP4050/CP4070/CP4070A/CP5030/CP5030A/ CP5150/CP5500
Differential Probes	DPB4080/DPB5150/DPB5150A/DPB5700/DPB5700A	



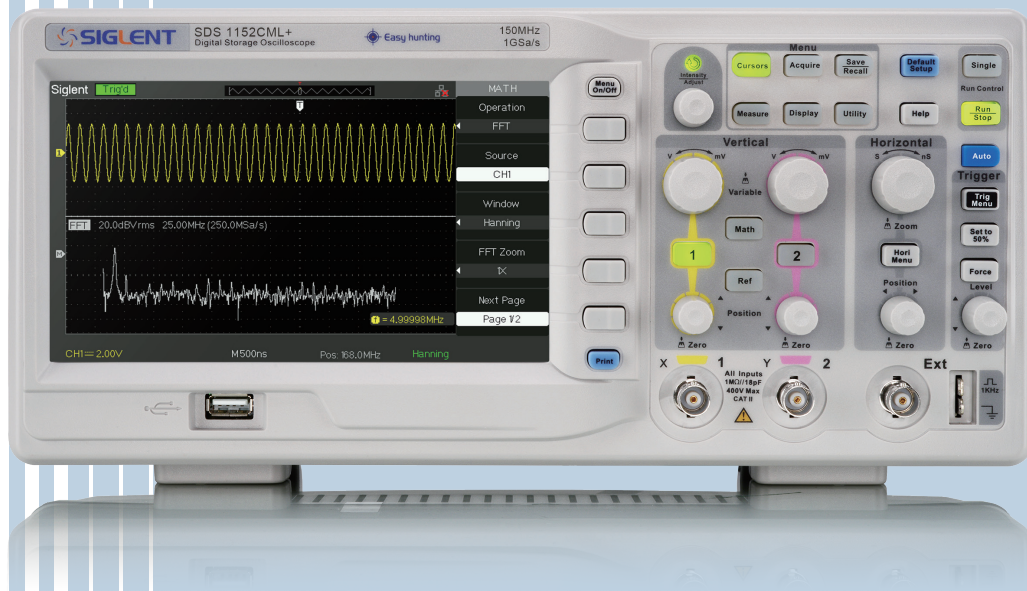

## SDS1000DL+/CML+ Series Digital Oscilloscope

### Application

- Electronic circuit design and debugging
- Electrical circuit function test
- Inspect instantaneous signal
- Industrial control and measuring
- Products quality control
- Education and training

### Key Features

- 50 MHz to 150 MHz Bandwidth
- 500 MSa/s~1 GSa/s sampling rate, 32 Kpts~2 Mpts memory depth
- 7 inch (8\*18 div) color TFT-LCD display
- 6 digits hardware frequency counter, real time counting display
- Waveform record and play back function
- Unique digital filter and data recorder function
- Embedded 12 languages, online help, one key storing and one key printing
- Interface: USB Device, USB Host, LAN, Pass/Fail
- Supports USB-TMC protocol and SCPI programming command control

## Specifications

Model	SDS1052DL+	SDS1072CML+	SDS1102CML+	SDS1152CML+
<b>Bandwidth</b>	50 MHz	70 MHz	100 MHz	150 MHz
<b>Channels</b>	2 CH +1 EXT			
<b>Real time sampling rate</b>	500 MSa/s	1 GSa/s	1 GSa/s	1 GSa/s
<b>Equivalent sampling rate</b>	50 GSa/s			
<b>Memory depth</b>	32 Kpts	2 Mpts	2 Mpts	2 Mpts
<b>Input impedance</b>	1 M $\Omega$   17 pF	1 M $\Omega$   17 pF	1 M $\Omega$   17 pF	1 M $\Omega$   17 pF
<b>Vertical sensitivity</b>	2 mv~10 v/div	2 mv~10 v/div	2 mv~10 v/div	2 mv~10 v/div
<b>Vertical resolution</b>	8 bit			
<b>Trigger source</b>	CH1, CH2, Ext, Ext/5, AC Line			
<b>Trigger types</b>	Edge, Pulse, Video, Slope, Alternative			
<b>Math operation</b>	+, -, *, /, FFT			
<b>Digital filter</b>	High pass, Low pass, Band pass, Band stop			
<b>Data recorder function</b>	√	√	√	√
<b>Max input voltage</b>	± 400 V (DC+AC Pk-Pk)			
<b>Internal storage</b>	2 groups of reference waveform, 20 groups of setting, 10 groups of waveform			
<b>External storage</b>	Bitmap save, CSV save, Waveform save, Setting save			
<b>Lasting</b>	Turn off, 1 s, 2 s, 5 s, infinite			
<b>Language</b>	English, French, German, Russian, Spanish, Simplified Chinese, Traditional Chinese, Portuguese, Japanese, Korean, Italian, Arabic			
<b>Interface</b>	USB Host, USB Device, LAN, Pass/Fail			
<b>Display</b>	7 inch color TFT-LCD			
<b>Power</b>	AC 100-240 V, 45 Hz-440 Hz, 50 VA Max			

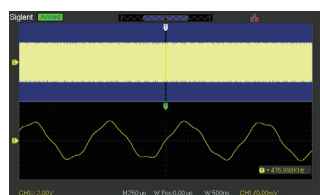

Normal Memory (40 kpts)

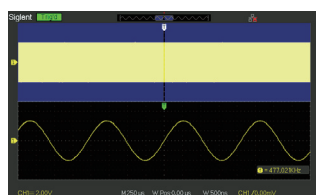

Long Memory (2 Mpts)



32 types of auto measurements



5 parameters display

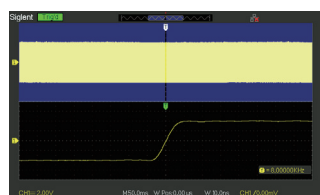

Zoom Function

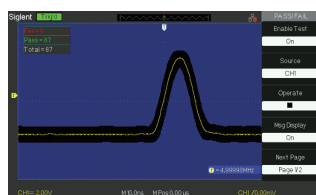

Pass/Fail Function

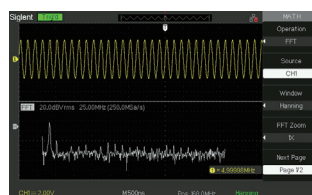

Math Function

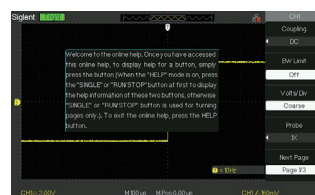

Embedded Online Help

## Standard Accessories





## SHS1000X/SHS800X Handheld Oscilloscope

### Application

- 200 MHz, 100 MHz bandwidth models
- Sample rate of 1 GSa/s (single-channel), Sample rate of 500 MSa/s (two-channels)
- The Siglent SPO technology
  - Waveform capture rates up to 100,000 wfm/s (normal mode) and 400,000 wfm/s (sequence mode)
  - Supports 256-level intensity grading and color temperature display modes
  - Record length up to 12 Mpts
  - Digital trigger system
- Intelligent trigger: Edge, Slope, Pulse Width, Window, Runt, Interval, Time out (Dropout), Pattern
- Serial bus triggering and decoding (Standard) for IIC, SPI, UART, CAN, and LIN protocols
- Video trigger/HDTV
- Low background noise with voltage scales from 2 mV/div to 100 V/div
- 3 one-button shortcuts for Oscilloscope, Multimeter and Recorder functions
- 8 one-button shortcuts for: Run/Stop, Auto Setup, Default, Measure, Cursors, Display/Persist, Clear Sweep and Print. More function shortcuts available when combined with the shift button
- Segmented acquisition (Sequence) mode, divides the maximum record length into multiple segments (up to 80,000), according to trigger conditions set by the user, with a very small dead time segment to capture the qualifying event
- History waveform record (History) function (maximum recorded waveform length is 80,000 frames)
- Automatic measurement function for 38 parameters as well as Measurement Statistics, Zoom, Gating, Math, History and Reference functions
- 1 Mpts FFT. Support Peaks and Markers
- Math and measurement functions use all sampled data points (up to 12 Mpts)
- Math functions (FFT, addition, subtraction, multiplication, division, integration, differential, square root)
- Default key can be customized for user settings or factory "defaults"
- Supports Multi-language display and embedded online help
- Security Erase mode
- Search and navigate function
- Includes Recorder mode, including Sample and Measurement Loggers
- 6000 counts Digital Multimeter, Support DCV, ACV, DCI, ACI, Resistance, Diode, Capacitance, Continuity test
- True RMS AC Voltage/Current measurement multimeter
- 5.6-inch TFT-LCD display with 640 \* 480 resolution
- Interface types: Isolated USB Host, USB Device (MicroUSB -TMC)
- Supports SCPI remote control commands
- UL2054 certified lithium battery pack, 6900 mAh capacity, external charger
- IP Rating: IP51
- Compliance with UL61010-1, UL61010-2-030, UL61010-2-033

## Characteristics

- Front panel and back panel



Front panel of the SHS1000X series



Rear of the SHS800X series

Large bright 5.6-inch TFT -LCD display with 640 \* 480 resolution. The most commonly used functions are accessible using 8 different one-button operation keys: Run/Stop, Auto Setup, Default, Cursor, Measure, Display/Persist, Clear Sweep, and Print. More function shortcuts are available combined with the shift button.

- When two channels are enabled, each channel has a maximum sample rate of 500 MSa/s. When a single channel is active, that channel has a sample rate of 1 GSa/s

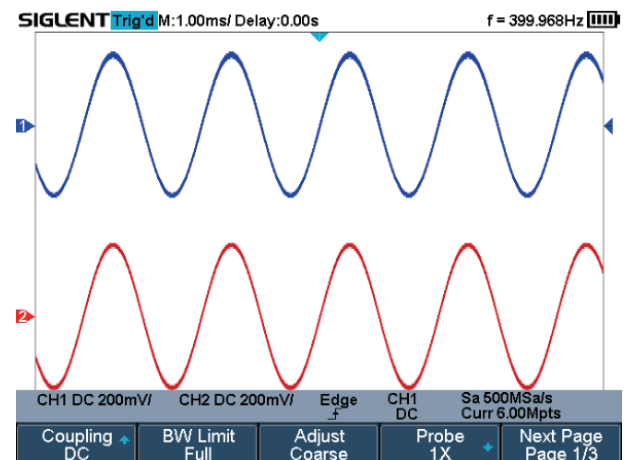
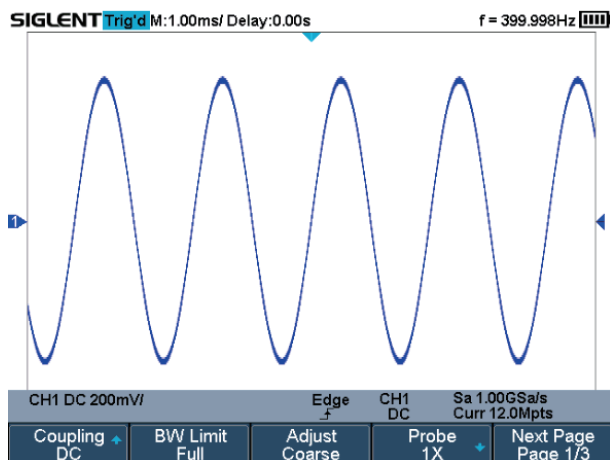

- Record Length of up to 12 Mpts

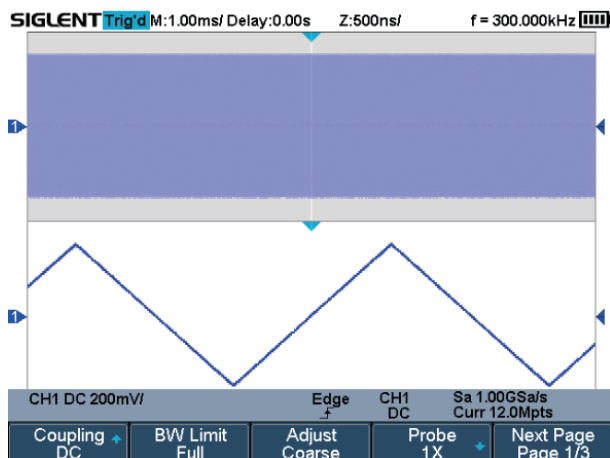

Using hardware-based Zoom technologies and max record length up to 12 Mpts, users can oversample to capture for longer periods at higher resolution and use the zoom feature to see more details within each signal.

- Waveform Capture Rate up to 400,000 wfms/s

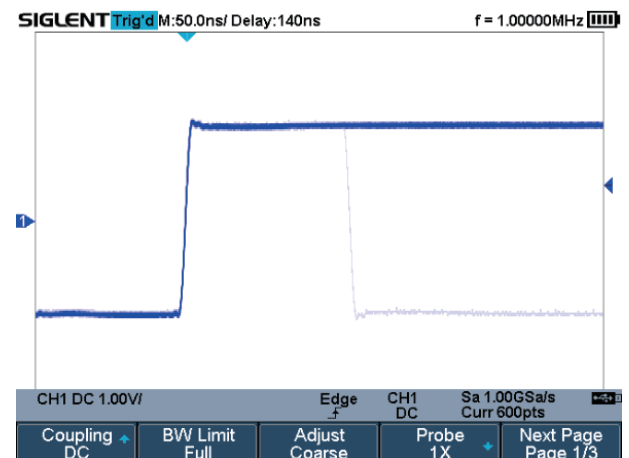

With a waveform capture rate of up to 400,000 wfms/s (sequence mode), the oscilloscope can easily capture unusual or low-probability events.

## • 256-Level Intensity Grading and Color Temperature Display

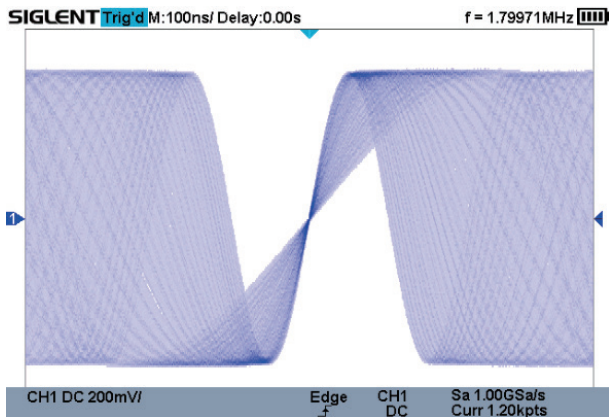

SPO display technology provides fast refresh rates. The resulting intensity-graded trace is brighter for events that occur with more frequency and dims when the events occur with less frequency.

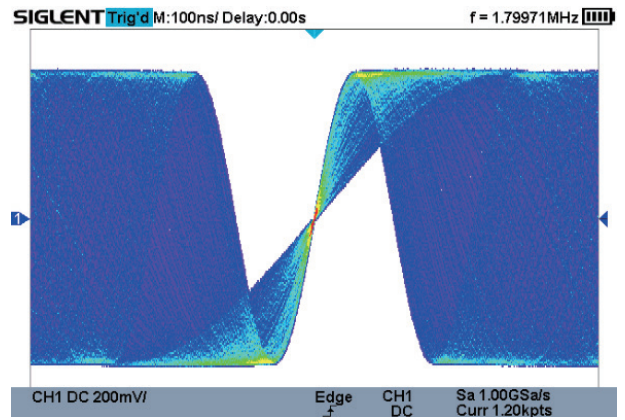

The color temperature display is similar to the intensity-graded trace function, but the trace occurrence is represented by different colors (color "temperature") as opposed to changes in the intensity of one color. Red colors represent events that occur more frequently, while blue is used to mark points that occur less frequently.

## • Serial Bus Decoding Function

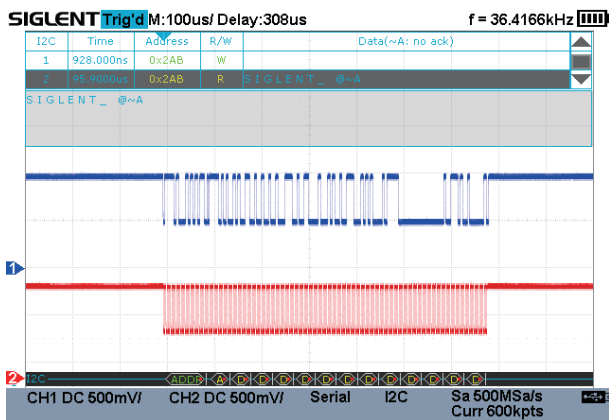

SHS800X/SHS1000X displays the decoding through the events list. Bus protocol information can be quickly and intuitively displayed in a tabular format.

## • History Waveforms (History) Mode and Segmented Acquisition (Sequence)

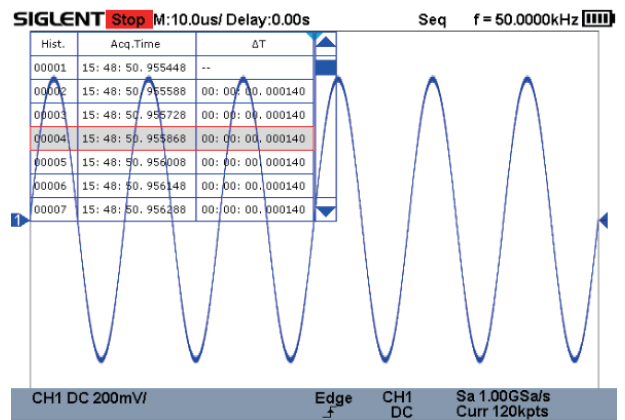

Playback the latest triggered events using the history function. Segmented memory collection will store trigger events into multiple (Up to 80,000) memory segments, each segment will store triggered waveforms and timestamps for each frame.

## • True measurement to 12 M points

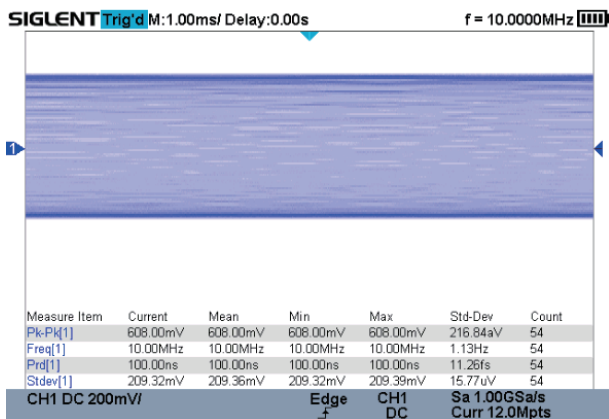

SHS800X/SHS1000X series can measure all sampled data points up to 12 Mpts. This ensures the accuracy of measurements while the math co-processor decreases measurement time and increases ease-of-use.

## • Gate and Zoom Measurement

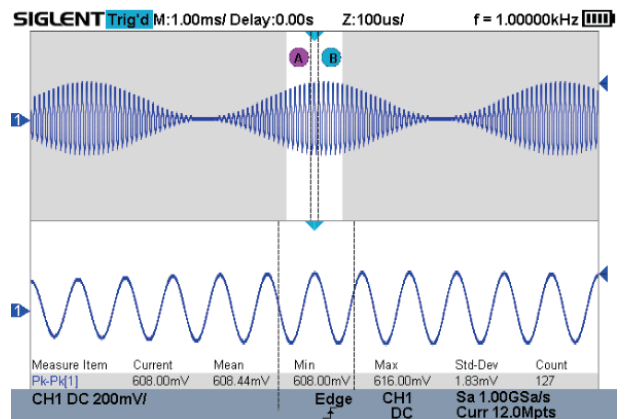

Through Gate and Zoom measurement, the user can specify an arbitrary interval of waveform data analysis and statistics. This helps avoid measurement errors that can be caused by invalid or extraneous data, greatly enhancing the measurements' validity and flexibility.

## • 1M points used to calculate the FFT

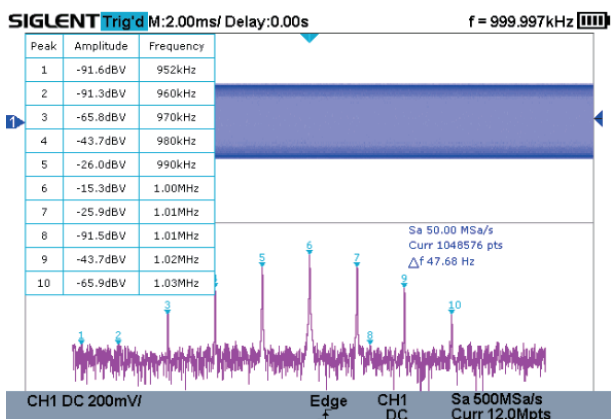

The new math co-processor enables FFT analysis of incoming signals using up to 1 M samples per waveform. This provides high-frequency resolution with a fast refresh rate. The FFT function also supports a variety of window functions so that it can adapt to different spectrum measurement needs. Support Peaks, Markers, a variety of numbers.

## • Customizable Default Key

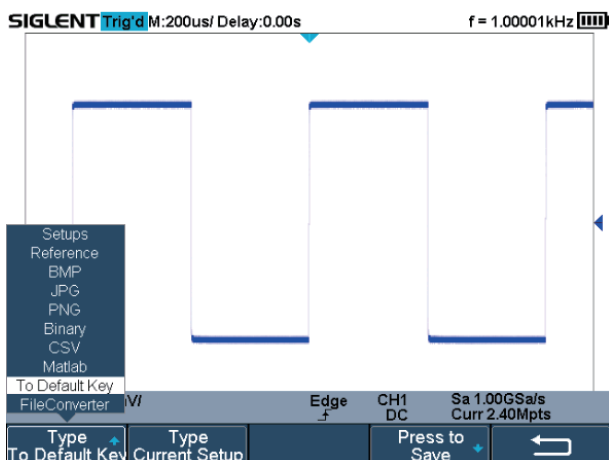

The current parameters of the oscilloscope can be preset to Default Key through the Save menu.

## • Search and Navigate

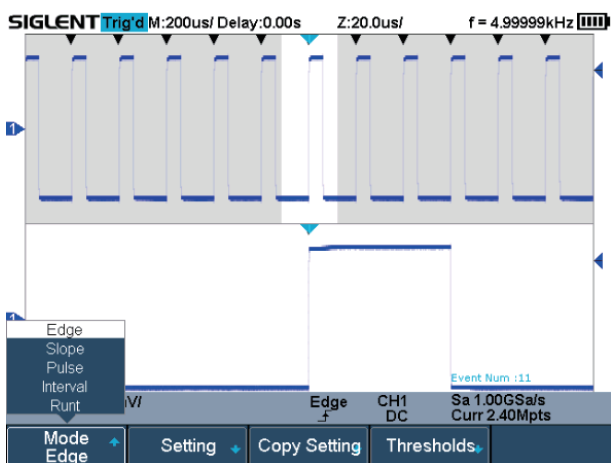

The SHS800X/SHS1000X series can search events specified by the user in a frame. It can also navigate by time (delay position) and historical frames.

## • 6000 Counts Digital Multimeter

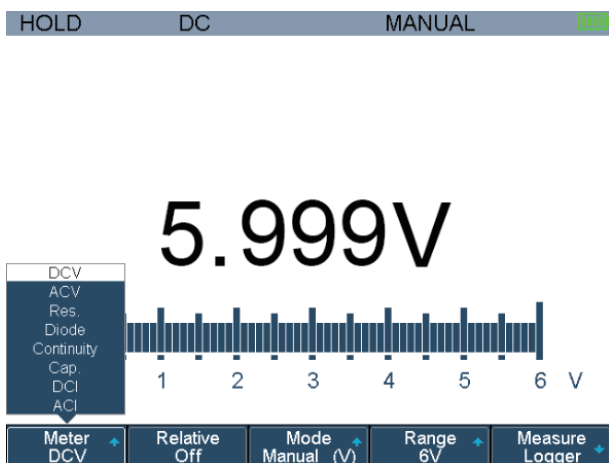

6000 count digital multimeter featured function of DCV, true RMS ACV, DCI, ACI, Diode, Resistance, Capacitance, and Continuity.

## • Sample Logger

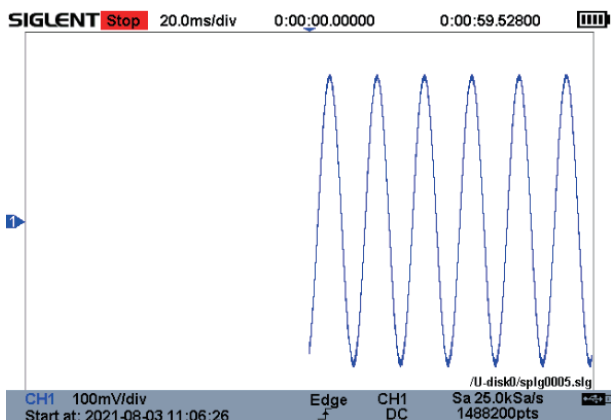

The Sample Logger is the mode of logging the sampling points for a long time. For there are many sampling points to log, they are logged into the internal flash or external U disk in real-time. After stopping logging, the user can recall the sampling points on the oscilloscope, or analyze the saved data on the computer.

## • Measurement Logger

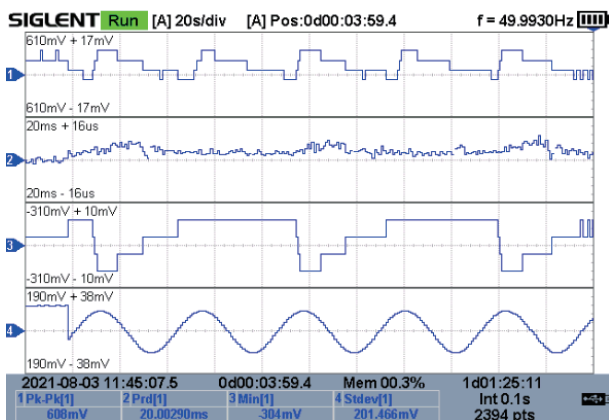

The measurement Logger is the mode of logging the measurement value for a long time. For the amount of measurement data is relatively small, to process quickly, the data is logged in memory. After stopping logging, the data can be saved into the internal flash or external U disk.

# Handheld Oscilloscope

## • Adapter/Battery



Wall power using the supplied adapter



Battery powered

SHS800X/SHS1000X supports adapter power supply and battery power supply. After connecting the adapter, the battery enters into charging mode. The adapter provides a maximum 4 A output current.

SHS800X/SHS1000X uses a UL2054 certified lithium battery package. The battery capacity of 6900 mAh can guarantee long-term operation without an external power supply for up-to 5.5 hours (SHS800X) and 4 hours (SHS1000X). The battery supports an external charger to further meet the requirements of portability.

## • Connectivity



Right side of the SHS800X series



Left side of the SHS1000X series

SHS800X/SHS1000X supports USB Host, USB Device (Micro USB -TMC)

## Specifications

Model	SHS810X	SHS820X	SHS1102X	SHS1202X
Bandwidth	100 MHz	200 MHz	100 MHz	200 MHz
Sample rate (Max.)	Two-channel share a single 1 GSa/s ADC. When two channels are enabled, each channel has a maximum sample rate of 500 MSa/s. When a single channel is active, that channel has a sample rate of 1 GSa/s			
Channels	2 analog oscilloscope channels, 1 multimeter channel			
Memory depth (Max.)	6 Mpts/CH (dual-channel mode) 12 Mpts/CH (single channel mode)			
Waveform capture rate (Max.)	100,000 wfms/s (normal mode), 400,000 wfms/s (sequence mode)			
Trigger type	Edge, Slope, Pulse Width, Window, Runt, Interval, Dropout, Pattern, Video			
Serial Trigger and decoder	IIC, SPI, UART, CAN, LIN			
Data Logger(Recorder)	Sample Logger. The Max sample rate is 25 kSa/s, the Min sample rate is 1 Sa/s Measurement Logger. The Max interval is 10 minutes, the Min interval is 0.1second. The Max items of logging is 4			
I/O	USB Host, USB Device			
Max input Voltage (Scope)	CAT II 300 Vrms Between BNC Signal and Protecting Earth CAT II 30 Vrms Between BNC GND and Protecting Earth CAT II 300 Vrms Between BNC Signal and BNC GND		CAT III 600 Vrms, CAT II 1000 Vrms Between BNC Signal and Protecting Earth CAT III 600 Vrms, CAT II 1000 Vrms Between BNC GND and Protecting Earth CAT III 300 Vrms Between BNC Signal and BNC GND	
Max input Voltage (Meter)	CAT III 300 Vrms, CAT II 600 Vrms		CAT III 600 Vrms, CAT II 1000 Vrms	
Probe	PP510	PP215	PB925	
Display	5.6-inch TFT-LCD (640x480)			
Weight	Without package 1.75 kg. With package 3.5 kg			

## Ordering Information

Product Name	SHS820X 200 MHz	
	SHS810X 100 MHz	
	SHS1202X 200 MHz Isolated Input	
	SHS1102X 100 MHz Isolated Input	
Standard Accessories	USB Cable -1	
	Quick Start -1	
	Passive Probe -2	
	Multimeter Test Lead -2	
	Certification -1	
	Power Adapter -1	
	Battery -1	
	SCD600MA Current Measurement Adapter -1	
	SCD10A Current Measurement Adapter -1	
Carrying Bag -1		
Optional Accessories	STB Demo Source	STB-3
	High Voltage Probe	HPB4010
	Current Probes	CP4020/CP4050/CP4070/CP4070A/CP5030/CP5030A/CP5150/CP5500/CPL5100
	Differential Probes	DPB1300/DPB4080/DPB5150/DPB5150A/DPB5700/DPB5700A
	Smart Battery Charger	GSCH4000A



## SDG7000A Arbitrary Waveform Generator

 Easy Pulse

True Arb



### Key Features

- Dual channel differential/single-ended output, 16-bit LVDS/LVTTL digital bus output
- High-performance sampling system with 5GSa/s sample rate and 14-bit vertical resolution
- 1 GHz maximum bandwidth
- Generates arbitrary waveform with sample rates of 0.01 Sa/s ~ 2.5 GSa/s, with maximum memory depth of 512 Mpts, and provides segment editing /playback functions
- Generates vector signals with up to 500 MS/s symbol rate
- Generates low jitter pulses with 1 ns minimum pulse width and 500ps minimum edge
- Up to 1 GHz bandwidth White Gaussian Noise and the bandwidth is adjustable
- Supports PRBS up to 312.5 Mbps
- The digital bus can output digital signals up to 1 Gbps
- Supports analog/digital modulation, sweeping and bursting
- Enhanced dual channel operation functions: inter channel tracking, coupling and copying; Dual channel superposition function; Supports mutual modulation between channels
- The 24 Vpp analog output is superimposed with  $\pm 12$  Vdc offset to provide a maximum output range of  $\pm 24$  V (48 V)
- High precision Frequency Counter
- 5-inch capacitive touch screen with resolution of 800x480; Supports external mouse and keyboard operation; Supports WebServer to control the instruments remotely
- Supports multiple interfaces: 10MHz In, 10MHz Out, Trigger In/Out, Markers etc
- Supports SCPI command for easy integration into test systems

## Characteristics

### • Multi-functional Waveform Generator



The SDG7000A series integrates multiple waveform generator functions from DC to continuous waves up to 1 GHz, which can replace RF signal generators in some applications. It adopts Siglent's TrueArb point-by-point arbitrary waveform generation technology, which enables user-adjustable output sample rates from 0.01 Sa/s to 2.5 GSa/s with excellent jitter performance and the generation of I/Q vector signals with a maximum settable bandwidth greater than 500 MHz. Using the benefits of Siglent's EasyPulse architecture, a low jitter pulse with a minimum pulse width of 1 ns can be generated. The SDG7000A also features a Gaussian noise output with adjustable bandwidth, Pseudo-random code generation, an optional 16 channels of digital signal output for synthesizing digital communications, and much more.

### • Wide Range Amplitude Output

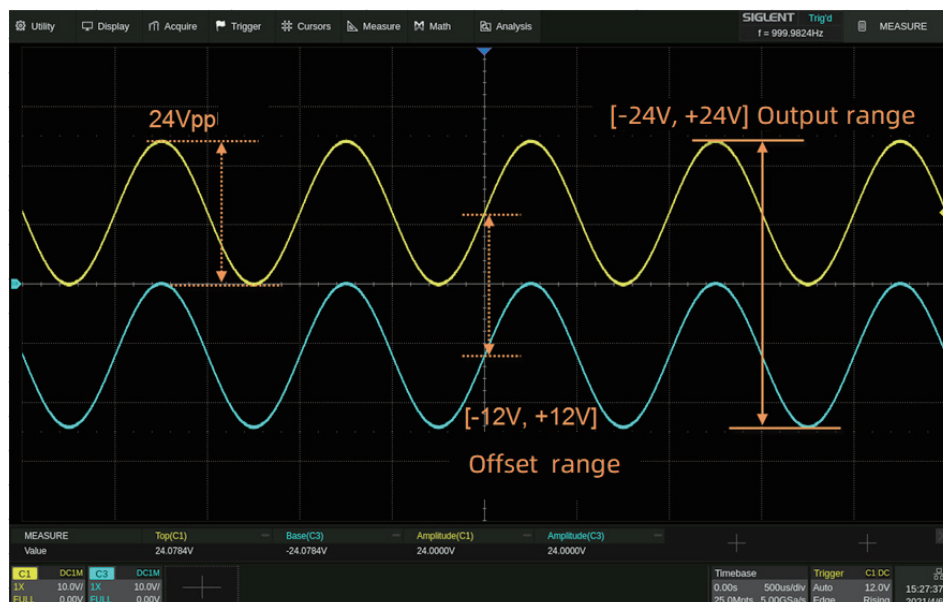

24Vpp analog output superimposed with  $\pm 12$  Vdc offset, providing a maximum output range of  $\pm 24$  V (48 V).

# Waveform Generator

## • Excellent Arbitrary Waveform Generation

### AFG mode

uses traditional DDS technology to generate arbitrary waveforms

### AWG mode

uses the innovative TrueArb technology, with an adjustable sample rate from 0.01 Sa/s~ 2.5 GSa/s and jitter less than 20 ps. It not only has all the advantages of traditional DDS technology, but also overcomes its intrinsic jitter and distortion defects. The flexible platform also provides zero order hold, linear and sinc interpolation methods for increased flexibility when creating complex waveforms.

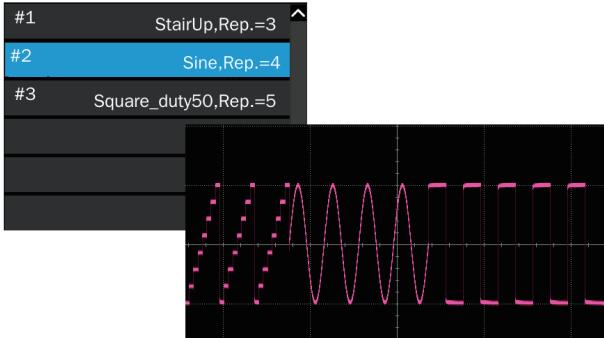

## Sequence editing and playback

The SDG7000A supports up to 1024 arbitrary wave segments, each of which can be set with a maximum of 65535 repetitions. When switching between segments, the output seamlessly moves from the last point of the previous segment to the first point of the next segment without generating an idle level. It is suitable for applications with high requirements for waveform switching.

## EasyWaveX

supports extensive arbitrary wave editing functions including manual, linear, coordinate, and equation drawing that facilitate rapid generation of the required waveforms. The EasyWaveX editing software is embedded in the SDG7000A, and can also be installed in a computer, interacting with the SDG7000A over USB or LAN interfaces.

## • High-Speed Low Jitter Pulse

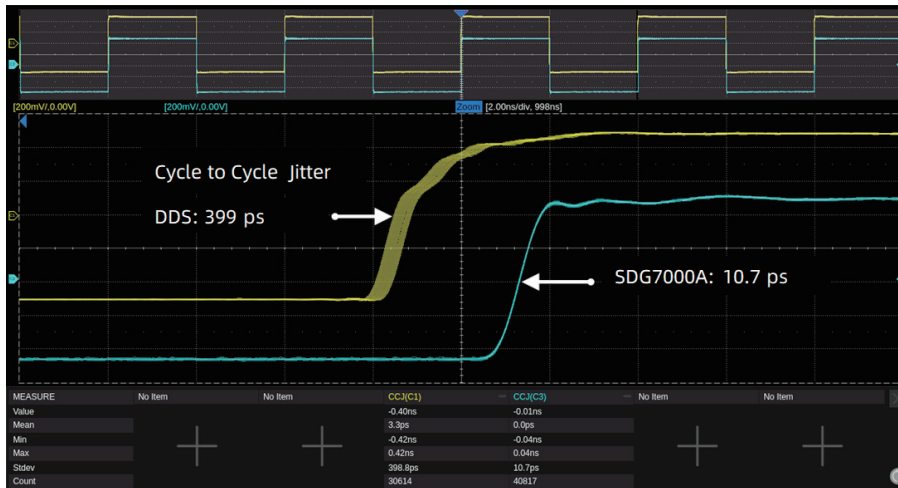

### Low jitter

When a Square/Pulse waveform is generated by traditional DDS, there can be additional jitter if the sample rate is not an integer-related multiple of the output frequency. EasyPulse technology successfully overcomes this weakness in DDS designs and helps to produce low jitter Square/Pulse waveforms.

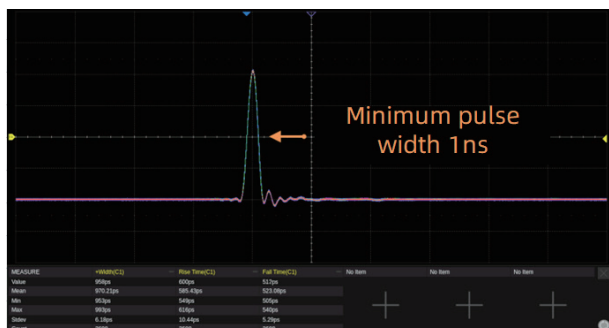

### High speed

The minimum 1 ns pulse width, can be generated at any frequency. The pulse width can be finely adjusted in steps of 10 ps.

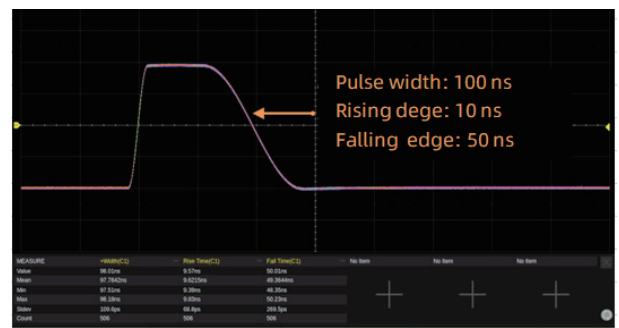

### Flexible edge

Adjustable fine step resolution to 100 ps. The minimum edge is 500 ps and can be generated at any frequency. The rising/ falling edge can be set respectively and can be used to generate asymmetric pulse

## • Vector Signal Output (Optional)

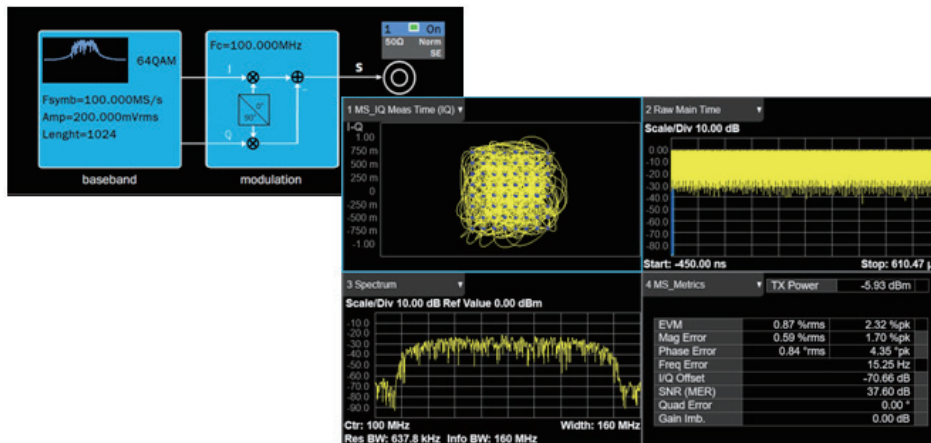

The SDG7000A can generate common modulation types of IQ signals, such as ASK, FSK, PSK, QAM. With the innovative resampling technology, excellent EVM performance can be obtained at any symbol rate between 250 S/s ~ 500 MS/s. The built-in digital quadrature modulator can modulate the carrier of the IQ signal to any frequency between 0 Hz~1 GHz. The EasyIQ software can be used to generate and edit various types of IQ signals.

## • Complex Signal Generator

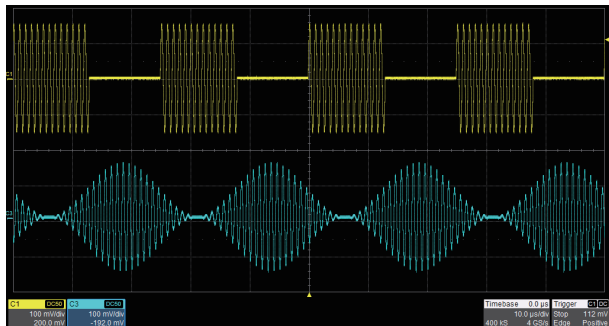

### Modulation

A variety of analog and digital modulation modes such as AM, FM, PM, FSK, ASK, PSK, DSB-SC, and PWM are supported. There are three modulation sources: Internal, External, and Channel.

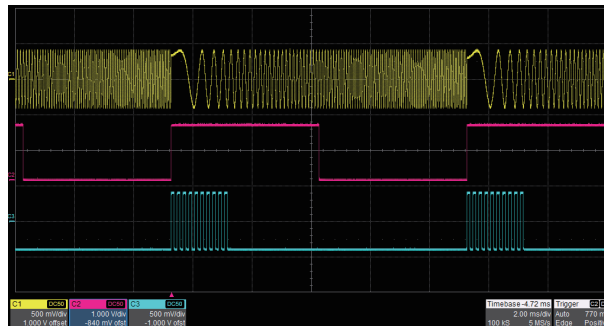

### Sweep and Burst

Sweep supports "Line" and "Log" modes, while Burst enables "NCycle" and "Gated" modes. Both Sweep and Burst support trigger sources: Internal, External, and Manual.

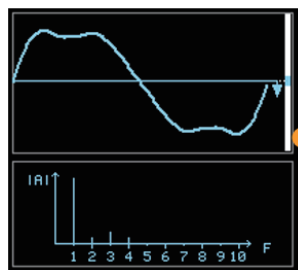

### Harmonics Function

provides the ability to add higher-order elements to your signal.

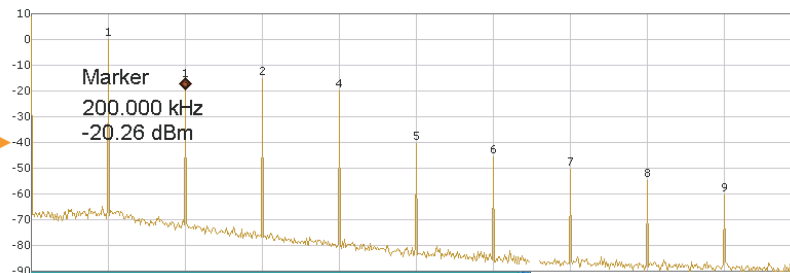

# Waveform Generator

## • 16 Channel Digital Output (Optional)

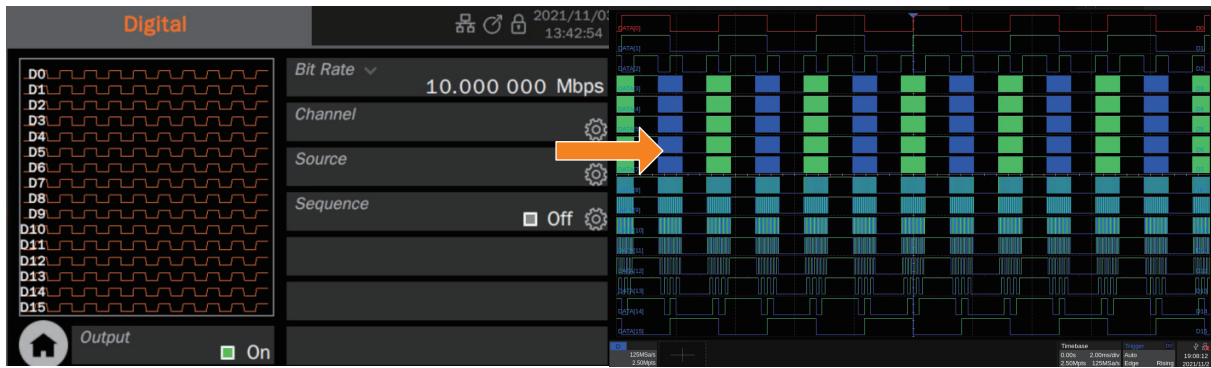

Purchase the corresponding digital bus kit to get 16-channel LVTTTL or LVDS output with a bit rate of 1  $\mu$ bps ~ 1 Gbps. Combine the digital bus with the analog channels to realize mixed-signal outputs.

## • Enhanced Dual Channel Functionality

### Two Dual-Channel Operation Mode



#### Independent mode

enables the two channels to be used as two independent generators. Independent mode also eliminated the discontinuity on the output when parameters (frequency, amplitude) change.



#### Phase-Locked mode

Automatically aligns the phases of each output.

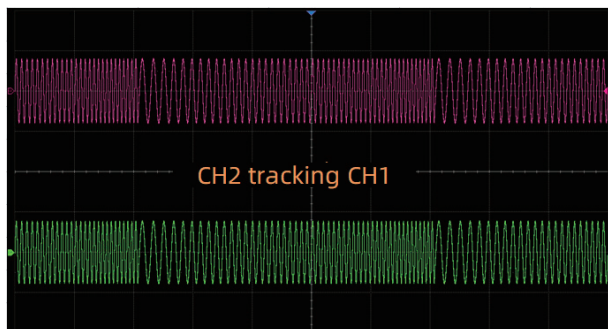

#### Track/Copy/Coupling

The track, copy and coupling functions between the two channels can quickly transfer the parameters of one channel to the other according to the requirements, greatly simplify the operation and meet the requirements of fast and synchronous switching waveforms.

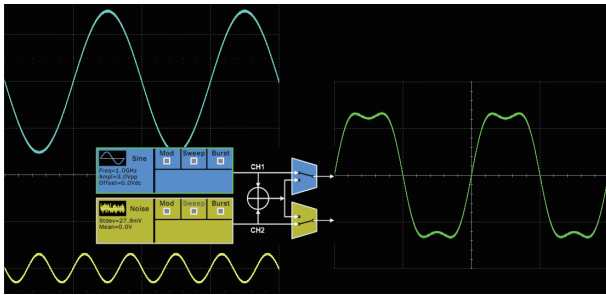

## Waveform Combining

Superimposes CH1 and CH2 waveforms internally and provides the combined waveform to a user-selected output. It easily combines basic waveforms, random noise, modulation signals, sweep signals, burst signals, EasyPulse waveforms, and TrueArb waveforms without external connections or complex editing.

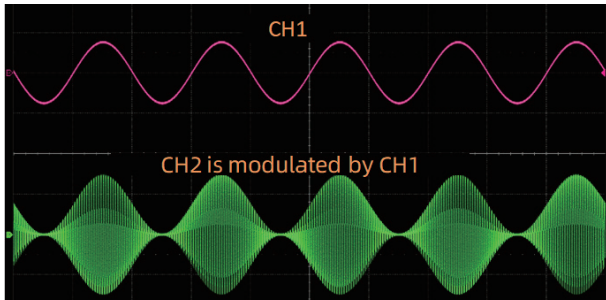

## Channel Modulation

One channel can modulate the other without external connections. This feature provides an easy method for complex modulation waveform creation. The modulating wave channel can be directly output and compared with the modulated signal.



## ● SigIQPro Signal Generation Software (Optional)

SigIQPro is a flexible PC-based signal generation software that takes signal generation to a whole new level, making it easy to generate complex signals that are fully compliant with Bluetooth, IoT and other communication standards. SIGLENT instruments and SigIQPro signal generation software integrate simulation, design and test to easily meet the needs of users at all stages of design, R&D, and production.

## Specifications

Model	SDG7102A	SDG7052A	SDG7032A
Number of channels	2 Differential/Single-ended		
Bandwidth	1 GHz	500 MHz	350 MHz
Sample rate	5 GSa/s		
Vertical resolution	14-bit		
Arbitrary waveform	0.01 Sa/s ~ 2.5 GSa/s sample rate; 24 pts ~ 512 Mpts/ch memory depth, with segment editing and playback		
Vector signal (Optional)	500 MS/s max symbol rate; Carrier DC ~ 1 GHz settable. Includes modulation modes such as ASK, PSK, FSK and QAM. EasyIQ software provides vector signal creation and editing		
Continuous waveform	Up to 1GHz, supports harmonic generation function		
Pulse	Min pulse width 1 ns, min. edge 500 ps pulse with low jitter, the rise/fall edge is independently fine adjustable, and the pulse width is fine adjustable		
Noise	Bandwidth 1 mHz ~ 1 GHz adjustable		
PRBS	Bit rate 1 $\mu$ bps ~ 312.5 Mbps, length PRBS3 ~ PRBS32		
Complex signal generation	Supports internal/external modulation, AM, FM, PM, PWM, FSK, PSK, ASK, etc.; Supports sweep; Support burst		
Dual-channel function	Inter channel tracking, coupling, and copying. Dual channel superposition function. Supports mutual modulation between channels		
Output range	24 Vpp analog output superimposed $\pm$ 12 V DC offset, supports a maximum output range of $\pm$ 24 V (48 V)		
Digital bus(Optional)	16-bit, LVTTTL or LVDS output Bit rate: 1 $\mu$ bps ~ 1 Gbps		
Interface	USB 2.0 Host x3, USB 2.0 Device(USBTMC) LAN 10M/100M (VXI-11/Telnet/Socket/WebServer) EXT MOD/CNT, 10MHz In, 10MHz Out, Marker x2, Trigger In/Out		
Interaction	5" TFT-LCD with capacitive touch screen (800x480) Supports mouse operation Supports Webserver Supports SCPI control		

## Ordering Information

Product Description	
SDG7102A	1 GHz, 5 GSa/s, 14-bit, 512 Mpts, 5-inch capacitive touch screen
SDG7052A	500 MHz, 5 GSa/s, 14-bit, 512 Mpts, 5-inch capacitive touch screen
SDG7032A	350 MHz, 5 GSa/s, 14-bit, 512 Mpts, 5-inch capacitive touch screen
Standard Configurations	
USB cable×1	
BNCcoaxial cable×2	
Quick start ×1	
Power cord ×1	
Wireless mouse×1	
Optional Configurations	Model
20 dB Attenuator	ATT-20dB
Single Instrument Rack Mount Kit	SSG-RMK
USB-GPIB Adapter	USB-GPIB
High precision OCXO (Installed at the factory, cannot be added after purchase)	10M_OCXO_L
Digital Bus Kit-LVTTL	DIG-LVTTL
Digital Bus Kit-LVDS (Without RF cables)	DIG-LVDS
Digital Bus Kit-LVDS (With 32 RF cables)	DIG-LVDS-2
IQ Signal Generator Function (software)	SDG-7000A-IQ
350 MHz to 500 MHz bandwidth upgrade (software)	SDG-7000A-BW05
500 MHz to 1 GHz bandwidth upgrade (software)	SDG-7000A-BW10

## SDG6000X Series Pulse/Arbitrary Waveform Generator



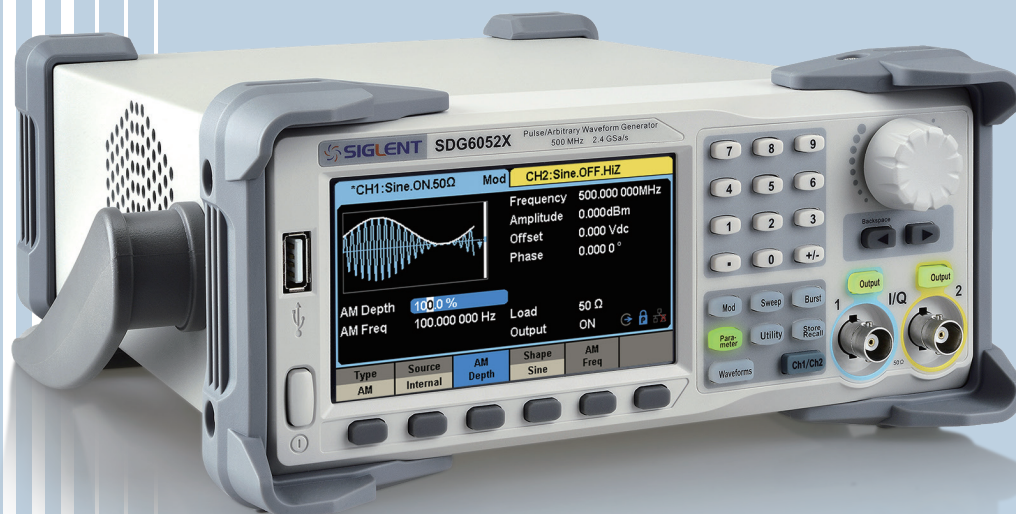

## Key Features

- Dual-Channel, 500 MHz maximum bandwidth, 20 Vpp maximum output amplitude, high fidelity output with 80 dB dynamic range
- High-performance sampling system with 2.4 GSa/s sampling rate and 16-bit vertical resolution
- Innovative TrueArb technology, based on a point-by-point architecture, supports any 8 pts~8 Mpts Arb waveform with a sampling rate in range of 1  $\mu$ Sa/s~75 MSa/s
- Innovative EasyPulse technology, capable of generating lower jitter Square or Pulse waveforms, brings a wide range and extremely high precision in pulse width and rise/fall times adjustment
- Multi-function signal generator, meeting requirements in wide range, Continuous Wave Generator, Pulse Generator, Function Arbitrary Waveform Generator, IQ Signal Generator (optional), Noise Generator, PRBS Generator
- Sweep and Burst function
- Harmonics function
- Waveform Combining function
- Channel Coupling, Copy and Tracking function
- 196 built-in arbitrary waveforms
- High precision Frequency Counter
- Standard interfaces include: USB Host, USB Device (USBTMC), LAN (VXI-11, Socket, Telnet), GPIB (Optional)
- 4.3" touch screen display for easier operation



## Characteristics

### • Continuous Wave

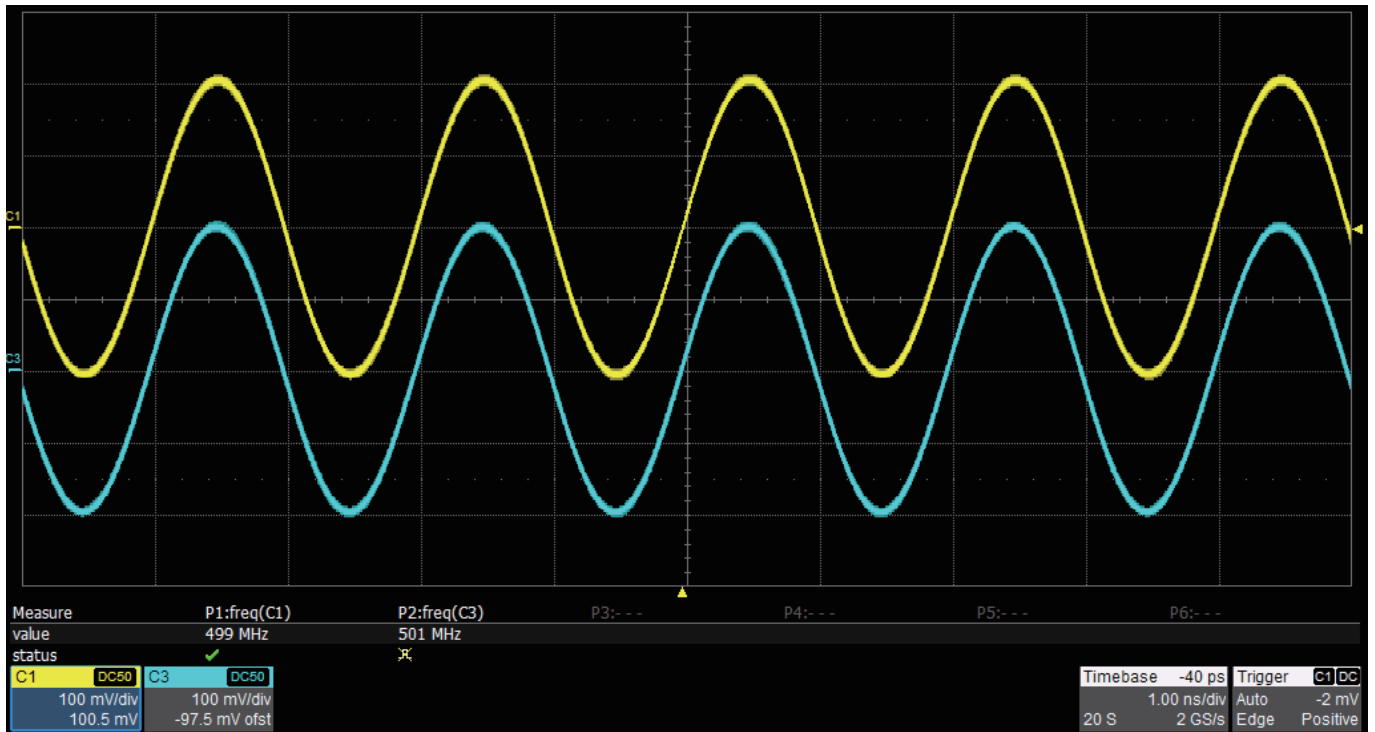

Up to 500 MHz continuous sine wave.

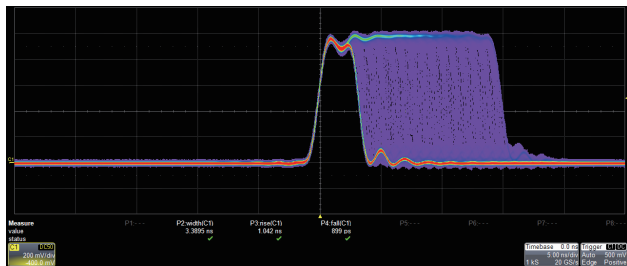

### • Pulse *Easy Pulse*

#### ◀ Adjustable Pulse Width

The pulse width can be fine-tuned to the minimum of 3.3 ns with an adjustment step as small as 100 ps, at any frequency.

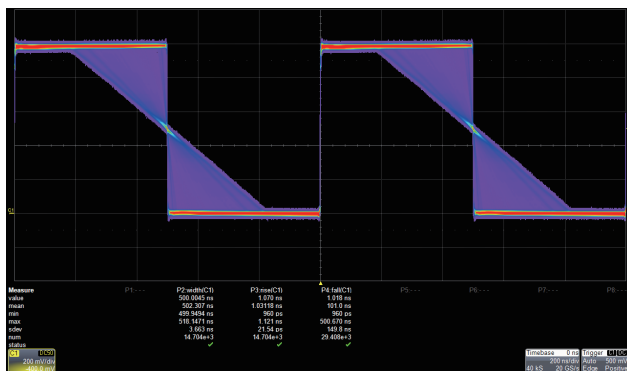

#### ◀ Adjustable Edge

The rise/fall times can be set independently to the minimum of 1 ns at any frequency with a minimum adjustment step as small as 100 ps.



#### ◀ Low Jitter

When a Square/Pulse waveform is generated by traditional DDS, there can be additional jitter if the sampling rate is not an integer-related multiple of the output frequency. EasyPulse technology successfully overcomes this weakness in DDS designs and helps to produce low jitter Square/Pulse waveforms.

## • Arbitrary Waveform *True Arb*

Traditional DDS designs can lead to additional jitter and distortion when sourcing arbitrary waveforms. The SIGLENT TrueArb design minimizes jitter and distortion to help deliver high fidelity arbitrary waveforms.

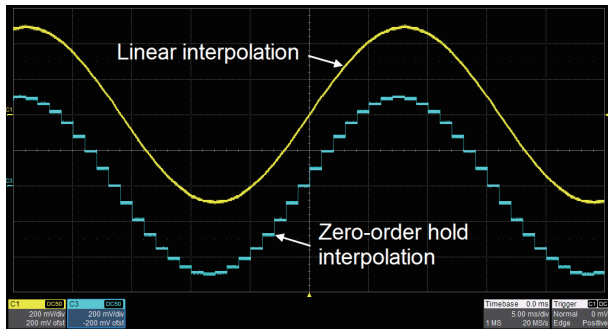

### Point by Point Output

TrueArb generates arbitrary waveforms point-by-point. It never skips any point so that it can reconstruct all the details of the waveform, as defined. Two interpolation modes are available: linear and zero-order hold.

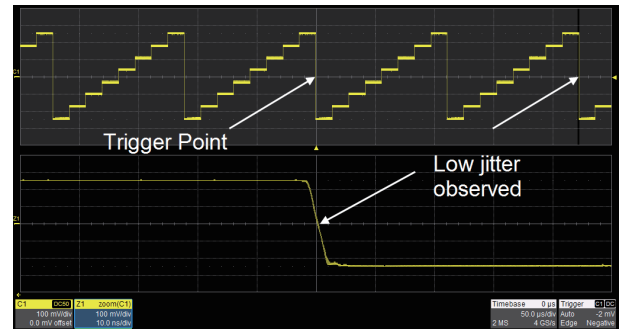

### Low Jitter

As with EasyPulse, TrueArb effectively overcomes the clock jitter that can effect traditional DDS generators.

## • PRBS

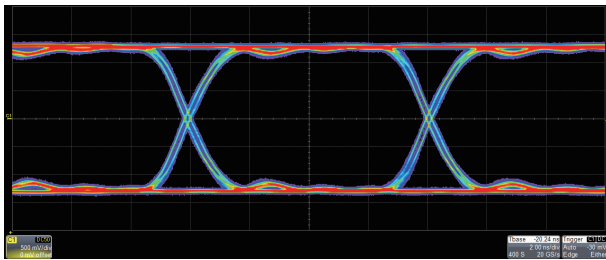

PRBS3 ~ PRBS32 with finely adjustable  $10^6$  bps ~ 300 Mbps bit rate and 1 ns ~ 1us edge.

\*CH1:PRBS.ON.50Ω
CH2:PRBS.ON.50Ω

Bit Rate 122.880 000Mbps

Amplitude 800.0mVpp

Offset 850.0mVdc

Length **PRBS-30**

Rise/Fall 2.0ns

Load 50 Ω

Output ON

TTL/CMOS
LVTTTL  
LVCOMS
ECL
LVPECL
LVDS
Differential  
ON

Preset common logic levels such as TTL, LVCMOS, LVPECL and LVDS. An added differential mode provides an easy way to generate differential signals using the both channels.

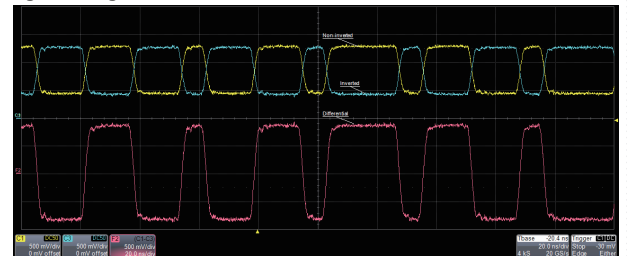

# Waveform Generator

## • IQ (optional)

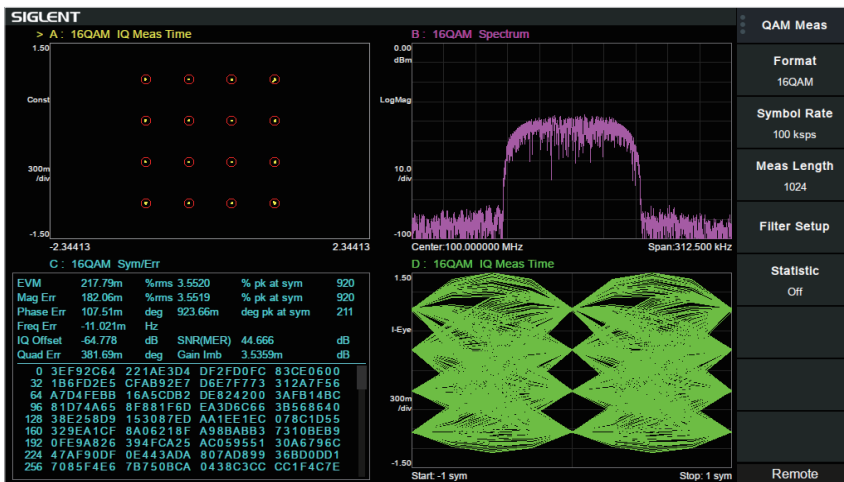
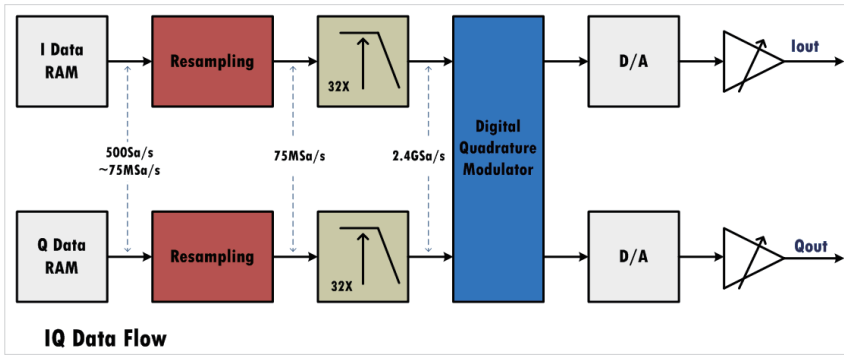

The SDG6000X supports popular modulation types such as ASK, FSK, PSK, and QAM. Proprietary resampling technology provides excellent EVM performance at arbitrary symbol rates between 250 Symb/s ~ 37.5 MSymb/s. Built-in digital quadrature modulator provides the possibility to generate IQ signals from baseband to 500 MHz intermediate frequency.



IQ waveforms can be generated by the PC software EasyIQ.

## • Complex Signals Generation

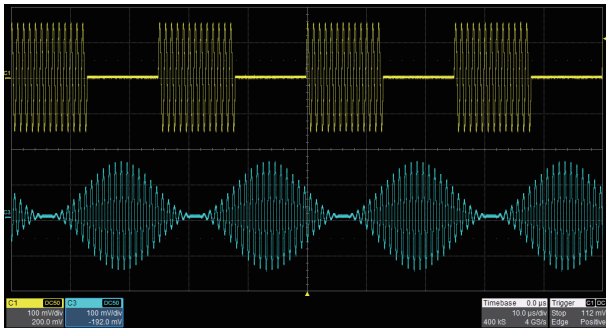

### Modulation

Plenty of modulation types, such as AM, FM, PM, FSK, ASK, PSK, DSB-AM, PWM are supported. The modulation source can be configured as "Internal" or "External".

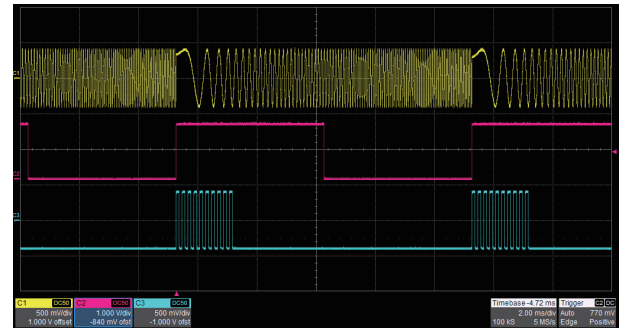

### Sweep and Burst

Sweep modes include "Linear" and "Log". Burst modes includes "N cycle" and "Gated". Both Sweep and Burst can be triggered by "Internal", "External" or "Manual" source.

## Waveform Combining

The waveform combining function superimposes CH1 and CH2 waveforms internally and provides the combined waveform to a user-selected output. Easily combine basic waveforms, random noise, modulation signals, sweep signals, burst signals, EasyPulse waveforms and TrueArb waveforms.

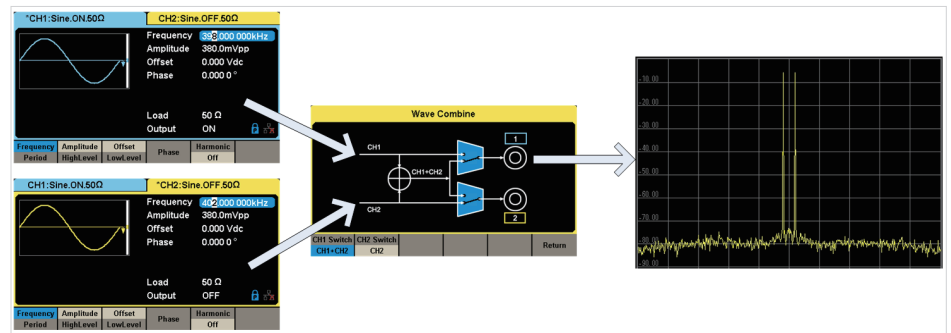

## Harmonics Function

Harmonics function gives you the ability to add higher-order elements to your signal.

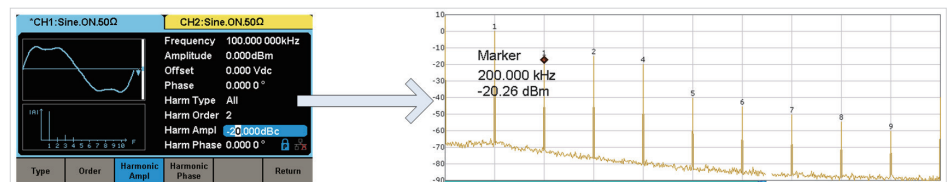

## • Two Dual-channel Operation Mode

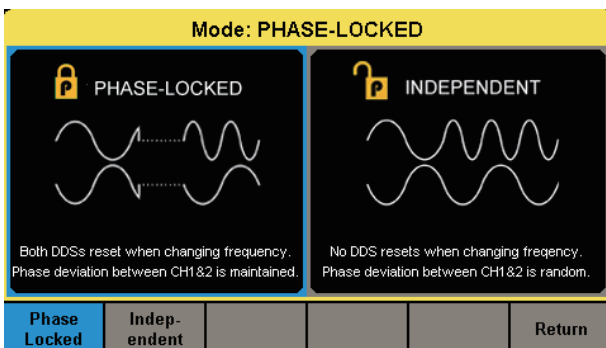

"Phase-Locked" mode automatically aligns the phases of each output. While "Independent" mode permit the two channels to be used as two independent generators. Independent mode also smoothes parameter (frequency, amplitude) changes made to an active channel.

## • Frequency Counter

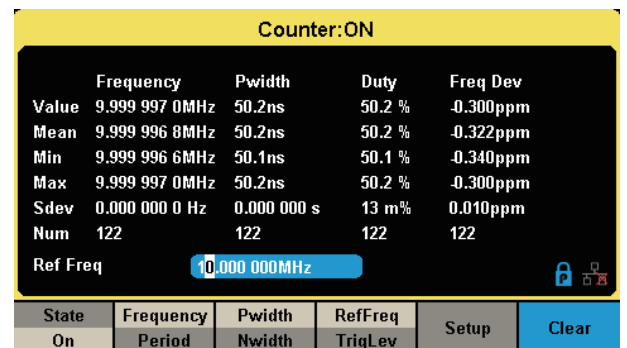

8-digit hardware frequency counter with statistics function and input range of 0.1 Hz ~ 400 MHz.

## Specifications

Model	SDG6022X	SDG6032X	SDG6052X
Bandwidth	200 MHz	350 MHz	500 MHz
Number of channels	2		
Sampling rate	2.4 GSa/s (2X Interpolation)		
Vertical resolution	16 bit		
Arbitrary waveform length	2 ~ 20 Mpts		
Display	4.3" touch screen display, 480 x 272 x RGB		
Interface	Standard: USB Host, USB Device, LAN Optional: GPIB (USB-GPIB adaptor)		

Frequency	
Resolution	±1 ppm (25°C )
	±2 ppm (0-40°C )
1st-year aging	±1 ppm (25°C )
10-year aging	±3.5 ppm (25°C )

Sine	
Harmonic distortion	0~1 MHz ( included ) < -65 dBc
	1~60 MHz ( included ) < -60 dBc
	60~100 MHz ( included ) < -50 dBc
	100~200 MHz ( included ) < -40 dBc
	200~300 MHz ( included ) < -30 dBc
	300 MHz ( included ) < -28 dBc
Total Harmonic Distortion	10 Hz ~ 20 kHz < 0.075%
Non-harmonic spurious	≤350 MHz < -60 dBc
	>350 MHz < -55 dBc

Pulse	
Frequency	1 μHz ~ 150 MHz (SDG6052X, SDG6032X) 1 μHz ~ 80 MHz (SDG6022X)
Pulse Width	≥3.3 ns
Pulse width accuracy	±(0.01%+0.3 ns)
Rise time ( setting range )	1 ns (10% ~ 90%) SDG6052X, SDG6032X 2 ns (10% ~ 90%) SDG6022X
Overshoot	3%, 100 kHz, 1 Vpp, 50 Ω load , 2 ns edge
Duty cycle	0.001% ~ 99.999% Limited by frequency setting
Duty cycle resolution	0.001%
Jitter (rms) cycle to cycle	<100 ps, 1 Vpp, 50 Ω load

Arbitrary Wave	
Frequency setting range	1 μHz ~ 50 MHz
Waveform length	2 pts ~ 20 Mpts
Sampling rate	1 uSa/s ~ 300 MSa/s (TrueArb mode)
	1.2 GSa/s (DDS mode)
Vertical resolution	16 bit
Jitter (rms) cycle to cycle	≤100 ps (1 Vpp, 50 Ω load , TrueArb mode)

Square	
Frequency	1 μHz~ 120 MHz (SDG6052X, SDG6032X) 1 μHz~ 80 MHz (SDG6022X)
Rise /fall times	2 ns~2.4 ns (10% ~ 90%, 1 Vpp, 50 Ω load)
Overshoot	≤3% (100 kHz, 1 Vpp, 50 Ω load)
Duty cycle	10% ~ 90% (Limited by frequency setting)
Jitter (rms) cycle to cycle	<100 ps (1 Vpp, 50 Ω load)

Output	
Accuracy	±(1%+1 mVpp) (10 kHz sine, 0 V offset)
Amplitude flatness	±0.3 dB (50 Ω load, 0.5 Vpp, compare to 1 MHz Sine)
Output impedance	50±0.5 Ω (100 kHz sine)
Output current	-200 ~ 200 mA
Crosstalk	< -60 dBc (CH1=CH2=0 dBm, Sine, 50 Ω load)

IQ (optional)	
Symbol rate	250 Symb/s ~ 37.5 MSymb/s (Limited by the oversampling factor)
Vertical resolution	16 bit
Modulation type	2ASK, 4ASK, 8ASK, BPSK, QPSK, 8PSK, DBPSK, DQPSK, D8PSK, 8QAM, 16QAM, 32QAM, 64QAM, 128QAM, 256QAM, 2FSK, 4FSK, 8FSK, 16FSK, MSK, MultiTone, custom (Supported by EasyIQ software)
Pattern	PN7, PN9, PN15, PN23, User file, Custom (Supported by EasyIQ software)
Output Range	1 mVrms ~ 0.5 Vrms ( $\sqrt{I^2 + Q^2}$ , 50 Ω load)
Carrier frequency	500 MHz (IF Output)

PRBS	
Bit rate	1 ubps~ 300 Mbps (SDG6052X, SDG6032X) 1 ubps~ 160 Mbps (SDG6022X)
Sequence length	$2^{m-1}$ , m = 3, 4, ... , 32
Rise/fall times	1 ns ~ 1 us (SDG6052X, SDG6032X. 10% ~ 90%, 1 Vpp, 50 Ω load) 2 ns ~ 1 us (SDG6022X. 10% ~ 90%, 1 Vpp, 50 Ω load)
Output Range (Note)	2 mVpp ~ 20 Vpp≤(40 Mbps, HiZ load)
	2 mVpp ~ 10 Vpp (40 ~ 240 Mbps ( included ), HiZ load)
	2 mVpp ~ 5 Vpp (240 Mbps, HiZ load)

## Ordering Information

Product Description	
SDG6052X	500 MHz, 2-CH, 2.4 GSa/s, 16-bit
SDG6032X	350 MHz, 2-CH, 2.4 GSa/s, 16-bit
SDG6022X	200 MHz, 2-CH, 2.4 GSa/s, 16-bit

Standard Configurations	
Quick start	×1
Power cord	×1
Calibration certificate	×1
USB cable	×1
BNC coaxial cable	x2

Optional Configurations	
SPA1010	10 W Power Amplifier
ATT-20dB	20 dB Attenuator
USB-GPIB	USB-GPIB Adapter
SDG-6000X-IQ	IQ Signal Generator Function

## SDG2000X Series Function/Arbitrary Waveform Generator

 Easy Pulse

 True Arb



### Key Features

- Dual-channel, 120 MHz maximum bandwidth, 20 Vpp maximum output amplitude, high fidelity output with 80 dB dynamic range
- High-performance sampling system with 1.2 GSa/s sampling rate and 16-bit vertical resolution. No detail in the waveforms will be lost
- Innovative TrueArb technology, based on a point-by-point architecture, supports any 8 pts~8 Mpts Arb waveform with a sampling rate in range of 1  $\mu$ Sa/s~75 MSa/s
- Innovative EasyPulse technology, capable of generating lower jitter Square or Pulse waveforms, brings a wide range and extremely high precision in pulse width and rise/fall times adjustment
- Plenty of analog and digital modulation types: AM、DSB-AM、FM、PM、PSK、FSK、ASK and PWM
- Practical functions: Channel Copy, Channel Coupling, Channel Track, harmonic generator, overvoltage protection function
- Sweep and Burst function, Harmonics mode supported
- High precision Frequency Counter
- Standard interfaces: USB Host, USB Device (USBTMC) , LAN (VXI-11)
- Optional interface: USB-GPIB
- 4.3" touch screen display for easier operation

## Characteristics

### • Excellent Analog Channel Performance

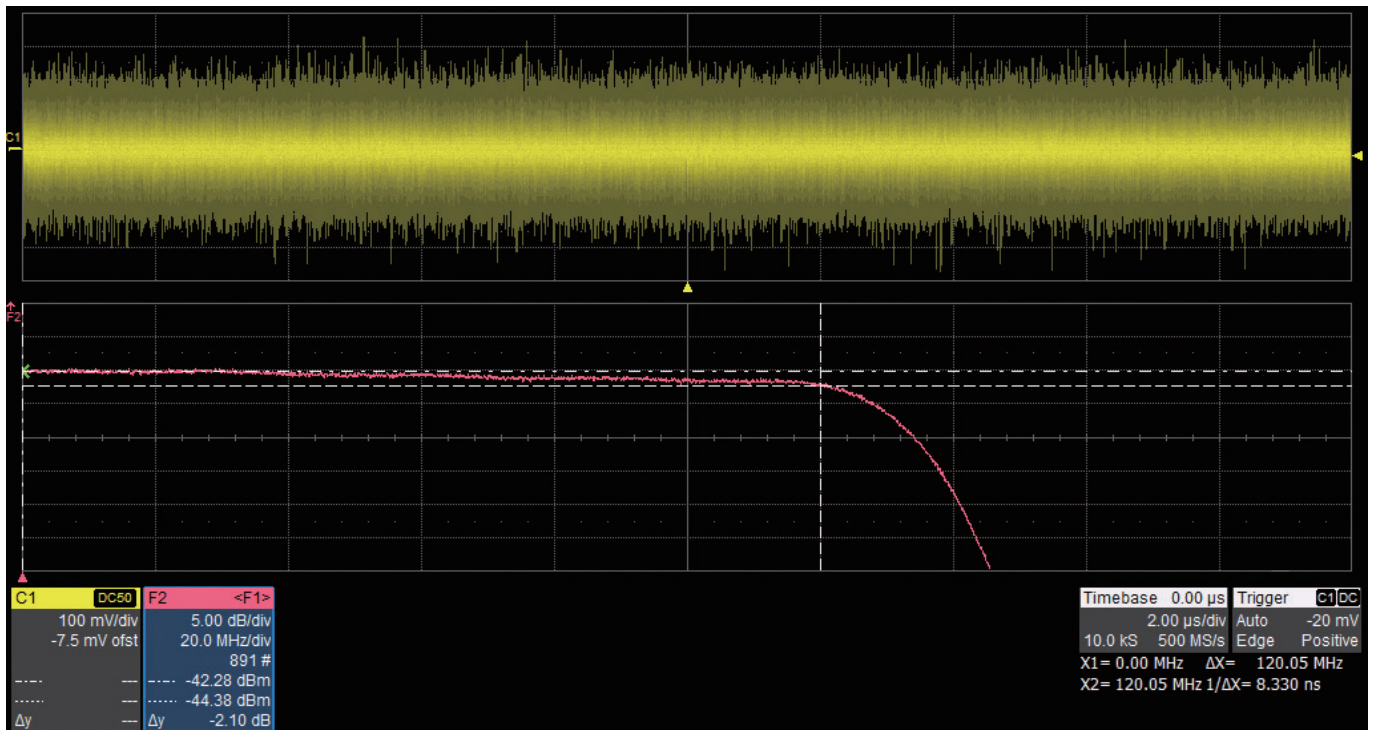

▲ The bandwidth of analog channels proves to be greater than 120 MHz, via doing a frequency response test with white noise.

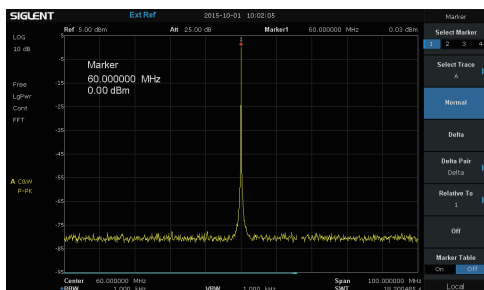

◀ High fidelity sine output. Almost no spurious observed @60 MHz, 0 dBm.

▶ Capacity of outputting large signal at high frequency. Dual-channel, 20 Vpp amplitude can be guaranteed even @20 MHz.

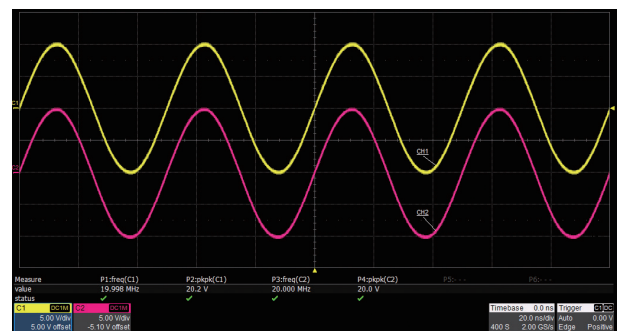

▶ Low noise floor, improves signal-noise ratio.





## • Innovative EasyPulse Technology

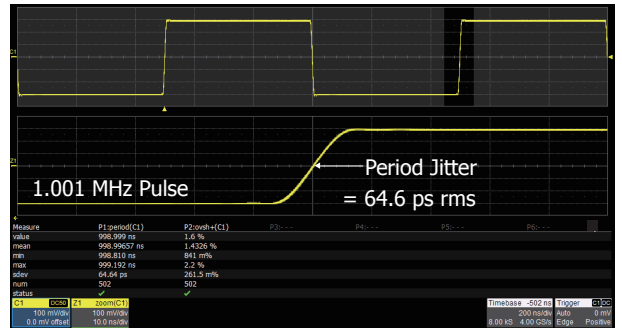
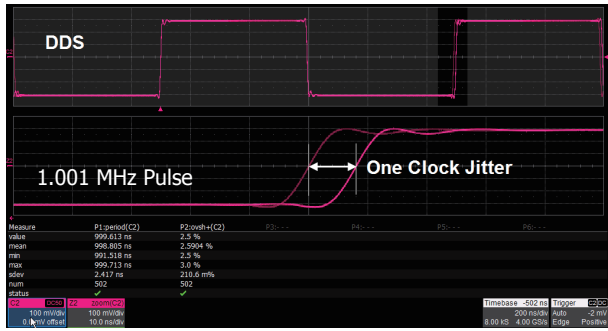

When a Square/Pulse waveform is generated by DDS, there will be a one-clock-jitter if the sampling rate is not an integer-related multiple of the output frequency. SDG2000X EasyPulse technology successfully overcomes this weakness in DDS designs and helps to produce low jitter Square/Pulse waveforms.

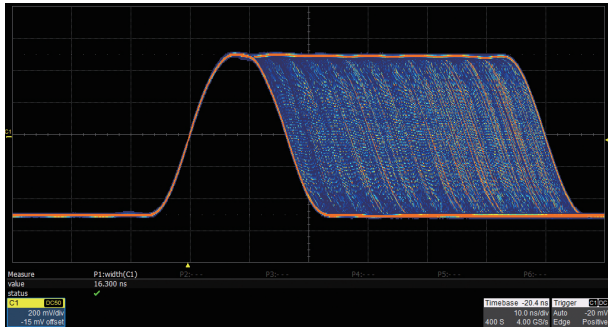

The Pulse width can be fine-tuned to the minimum of 16.3 ns with the adjustment step as small as 100 ps.

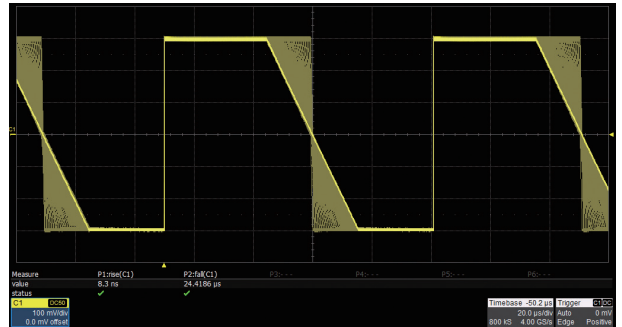

The rise/fall times can be set independently to the minimum of 8.4 ns at any frequency and to the maximum of 22.4 s. The adjustment step is as small as 100 ps.

## • Innovative TrueArb Technology

For arbitrary waveforms, TrueArb not only has all the advantages of traditional DDS, but also eliminates the probability that DDS may cause serious jitter and distortion.

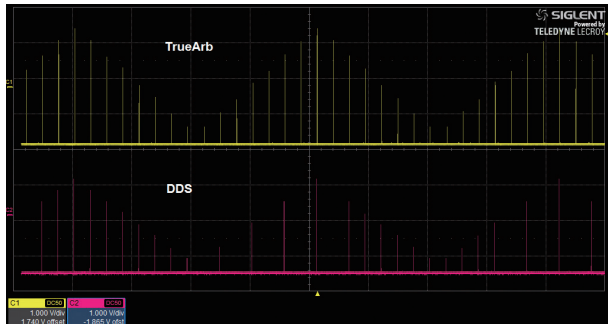

TrueArb generates arbitrary waveforms point by point, never skips any point so that it can reconstruct all the details of the waveform as defined.

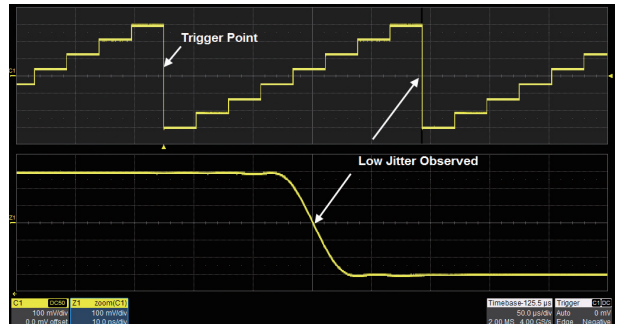

As with EasyPulse, TrueArb effectively overcomes the defect that DDS may cause the one-clock-jitter in arbitrary waveforms.

## • 4.3" Touch Screen Display

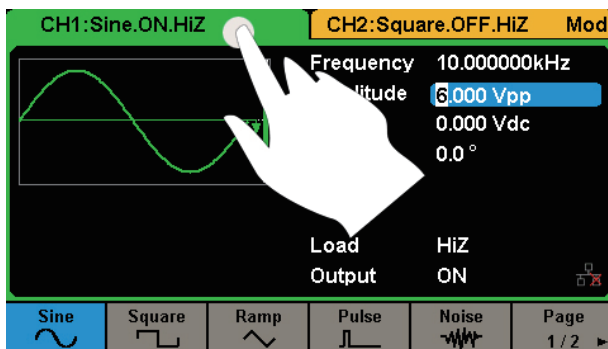

4.3" touch screen display, makes operation much more convenient.

## • Arbitrary Waveform Software EasyWave

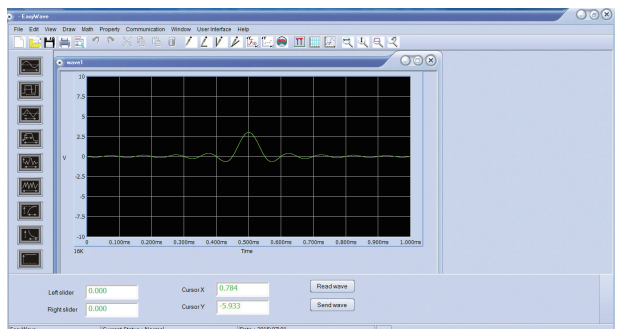

EasyWave is a powerful arbitrary waveform editing software that supports several ways to generate arbitrary waveform such as manual drawing, line-drawing, equation-drawing, coordinate-drawing, etc. It is quite convenient for users to edit their own arbitrary waveforms through EasyWave.

## Characteristics

### • High-performance Sampling System

Benefiting from a 1.2 GSa/s and 16-bit sampling system, SDG2000X achieves extremely high accuracy performance in both time domain and amplitude, which results in more accurately reconstructed waveforms and lower distortion.

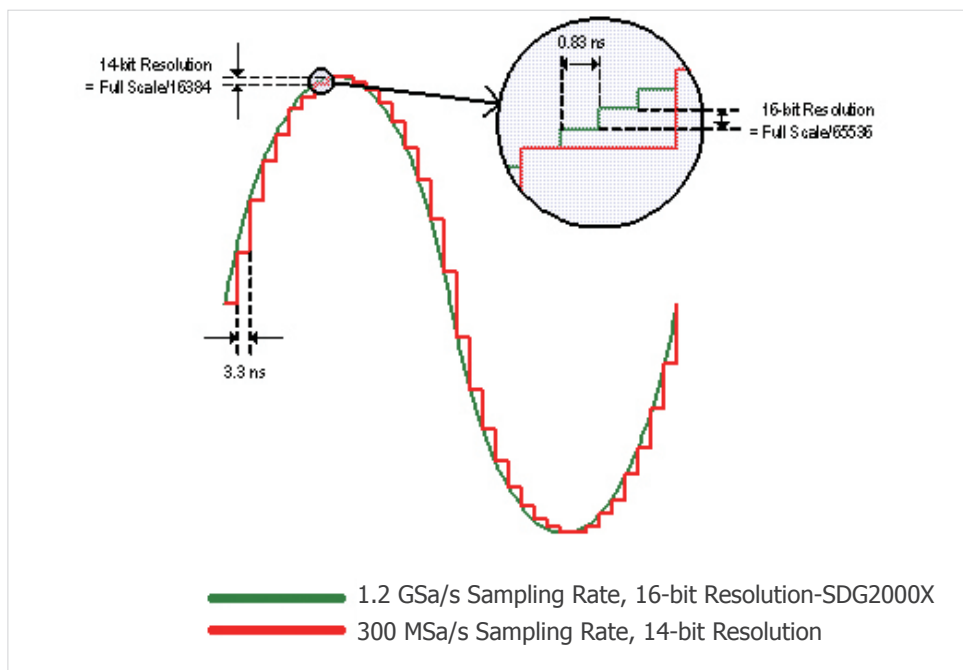

## Specifications

Product Model	SDG2042X	SDG2082X	SDG2122X		
Bandwidth	40 MHz	80 MHz	120 MHz		
Sampling rate	1.2 GSa/s (4 X Interpolation)				
Vertical resolution	16 bit				
Num. of channels	2				
Max. amplitude	±10 V				
Display	4.3" touch screen display, 480 x 272 x RGB				
Interface	Standard: USB Host, USB Device, LAN Optional: GPIB (USB-GPIB adaptor)				
Frequency Characteristics					
Parameter	Min.	Typ.	Max.	Unit	Condition
Resolution			1 μ	Hz	
Initial accuracy	-1		+1	ppm	25°C
	-2		+2	ppm	0~40°C
1 <sup>st</sup> -year aging	-1		+1	ppm	25°C
10-year aging	-3.5		+3.5	ppm	25°C
Sine Characteristics					
Parameter	Min.	Typ.	Max.	Unit	Condition
Frequency	1 μ		120 M	Hz	
Harmonic distortion			-65	dBc	0 dBm, 0~10 MHz (Included)
			-60	dBc	0 dBm, 10~20 MHz (Included)
			-55	dBc	0 dBm, 20~40 MHz (Included)
			-50	dBc	0 dBm, 40~60 MHz (Included)
			-45	dBc	0 dBm, 60~80 MHz (Included)
			-40	dBc	0 dBm, 80~100 MHz (Included)
			-38	dBc	0 dBm, 100~120 MHz (Included)
Total Harmonic Distortion			0.075	%	0 dBm, 10 Hz ~ 20 kHz
Non-harmonic spurious			-70	dBc	≤50 MHz
			-65	dBc	>50 MHz

# Waveform Generator

Square Characteristics					
Parameter	Min.	Typ.	Max.	Unit	Condition
Frequency	1 $\mu$		25 M	Hz	
Rise/fall times			9	ns	10% ~ 90%, 1 Vpp, 50 $\Omega$ Load
Overshoot			3	%	100 kHz, 1 Vpp, 50 $\Omega$ Load
Duty cycle	0.001		99.999	%	Limited by frequency setting
Jitter (rms), Cycle to cycle			150	ps	1 Vpp, 50 $\Omega$ Load

Pulse Characteristics					
Parameter	Min.	Typ.	Max.	Unit	Condition
Frequency	1 $\mu$		25 M	Hz	
Pulse width	16.3			ns	
Pulse width accuracy			$\pm(0.01\%+0.3 \text{ ns})$		
Rise/fall times	8.4 n		22.4	s	10% ~ 90%, 1 Vpp, 50 $\Omega$ Load, Subject to pulse width limits
Overshoot			3	%	100 kHz, 1 Vpp
Duty cycle	0.001		99.999	%	Limited by frequency setting
Duty cycle resolution	0.001			%	
Jitter (rms) cycle to cycle			150	ps	1 Vpp, 50 $\Omega$ Load

Arbitrary Wave characteristics					
Parameter	Min.	Typ.	Max.	Unit	Condition
Frequency	1 $\mu$		20 M	Hz	
Waveform length	8		8 M	pts	
Sampling rate	1 $\mu$		75 M	Sa/s	TrueArb mode
	300			MSa/s	DDS mode
Vertical resolution	16			bit	
jitter (rms)			150	ps	1 Vpp, 50 $\Omega$ Load, TrueArb mode

Output Characteristics					
Parameter	Min.	Typ.	Max.	Unit	Condition
Range (Note 1)	2 m		20	Vpp	$\leq 20$ MHz, HiZ load
	2 m		10	Vpp	$> 20$ MHz, HiZ load
	1 m		10	vpp	$\leq 20$ MHz, 50 $\Omega$ load
	1 m		5	vpp	$> 20$ MHz, 50 $\Omega$ load
Accuracy	$\pm (1\%+1 \text{ mVpp})$				10 kHz sine, 0 V offset
Amplitude flatness	-0.3		+0.3	dB	0~100 MHz (Included), 50 $\Omega$ load, 2.5 Vpp, compare to 10 kHz Sine
	-0.4		+0.4	dB	100~120 MHz (Included), 50 $\Omega$ load, 2.5 Vpp, compare to 10 kHz Sine
Output impedance	49.5	50	50.5	$\Omega$	10 kHz sine
Output current	-200		200	mA	
Crosstalk			-60	dBc	CH1 - CH2/CH2 - CH1

Note 1: The specification will be divided by 2 while applied to a 50  $\Omega$  load.

## Ordering Information

Product Description	SDG2000X Series Function/Arbitrary Waveform Generator
Product code	SDG2042X 40 MHz
	SDG2082X 80 MHz
	SDG2122X 120 MHz
Standard configurations	A Quick Start, A Power Cord, A USB Cable, A Calibration Certificate, A BNC Coaxial Cable
Optional configurations	USB-GPIB adapter

# SDG1000X

## Function/Arbitrary Waveform Generator

*Easy Pulse*

*True Arb*



### Application

- IC test
- Simulate sensor
- Simulate environment signals
- Electrical circuit function test
- Education and training

### Key Features

- Dual-channel, with bandwidth up to 60 MHz, and amplitude up to 20 Vpp
- 150 MSa/s sampling rate, 14-bit vertical resolution, and 16 kpts waveform length
- Innovative EasyPulse technology, capable of generating lower jitter Pulse waveforms, brings a wide range and extremely high precision in pulse width and rise/fall times adjustment
- Innovative TrueArb technology, based on a point-by-point architecture, supports any 8 pts~8 Mpts Arb waveform with a sampling rate in range of 1  $\mu$ Sa/s~75 MSa/s
- Special circuit for Square wave function, can generate Square waves up to 60 MHz with jitter less than 300 ps+0.05 ppm of period
- Plenty of analog and digital modulation types: AM, DSB-AM, FM, PM, FSK, ASK, PSK and PWM
- Sweep and Burst functions
- Harmonics Generator function
- Waveform Combining function
- High precision Frequency Counter
- Standard interfaces: USB Host, USB Device (USBTMC), LAN (VXI-11)
- Optional interface: GPIB
- 4.3" TFT-LCD display

## Models and Key Specifications

Product Model	SDG1032X	SDG1062X
Bandwidth	30 MHz	60 MHz
Sampling rate	150 MSa/s	
Vertical resolution	14-bit	
Waveform Length	16 kpts	
Num. of channels	2	
Max. amplitude	±10 V	
Display	4.3" display, 480 x 272 x RGB	
Interface	Standard: USB Host, USB Device, LAN Optional: GPIB (USB-GPIB adaptor)	

## Characteristics

### • Identical dual output-channels with high performance

Capable of outputting large signals at high frequencies. dual-channels, 20 Vpp amplitude can be guaranteed at up to 10 MHz.

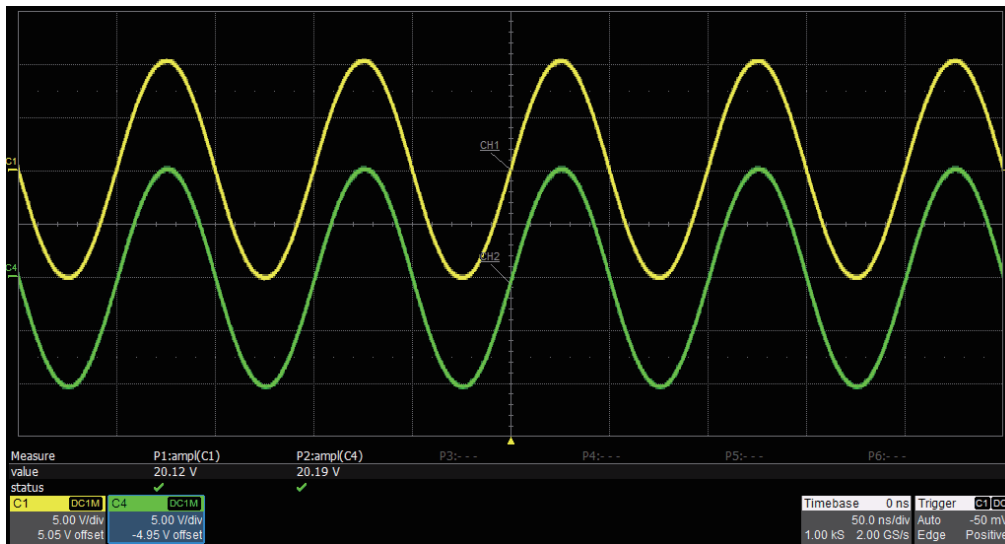

### • Low Distortion Output

With 0 dBm output, the THD (Total Harmonic Distortion) is less than 0.075%. Harmonics and spurs are less than -40 dBc throughout the entire bandwidth.

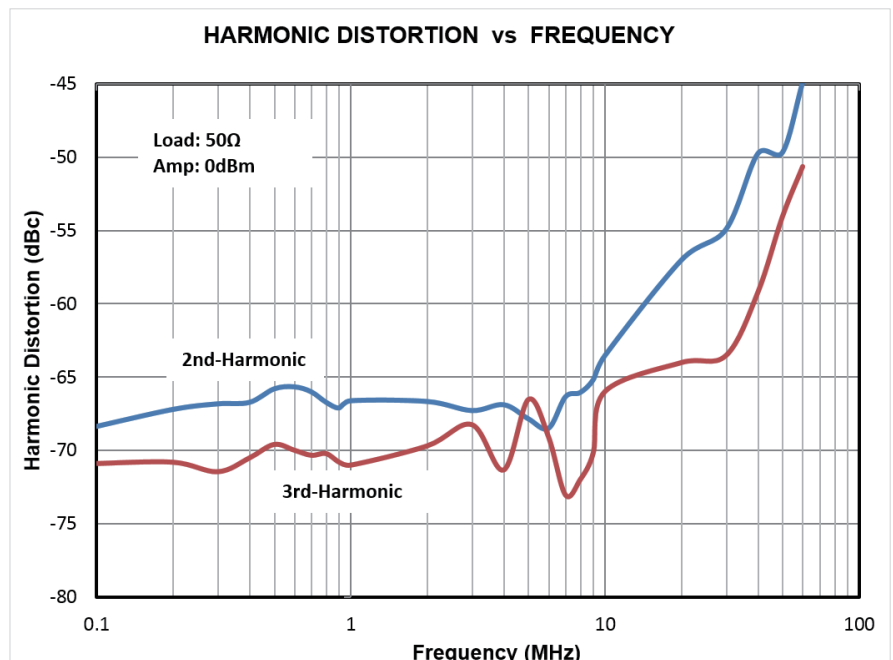

## • Innovative EasyPulse Technology

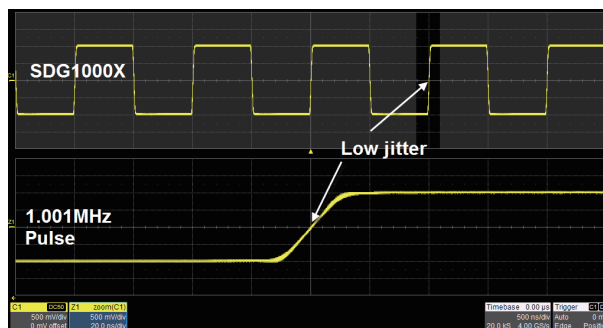
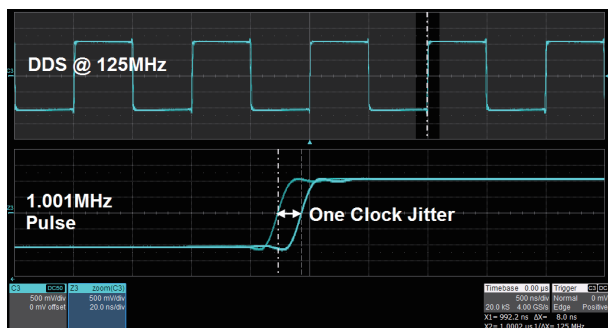

When a Pulse waveform is generated by a common DDS generator, there will be a one-clock-jitter if the sampling rate is not an integer-related multiple of the output frequency. SDG1000X EasyPulse technology successfully overcomes this weakness in DDS designs and helps to produce low jitter Pulse waveforms.

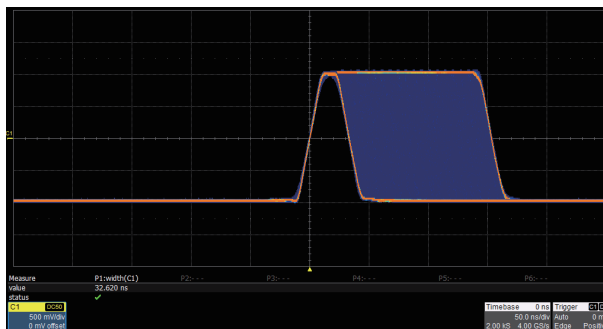
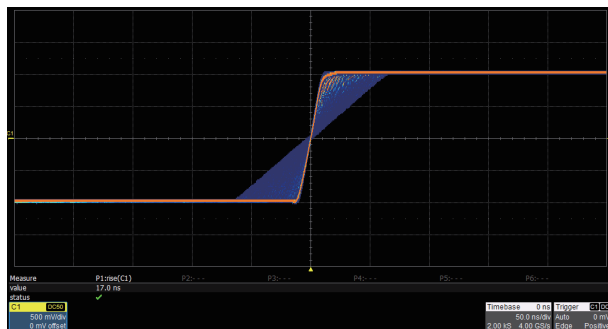

The rise/fall times can be set independently to the minimum of 16.8 ns at any frequency and to the maximum of 22.4 s. The adjustment step is as small as 100 ps. The Pulse width can be fine-tuned to the minimum of 32.6 ns with the adjustment step as small as 100 ps.

## • High performance Square Waves

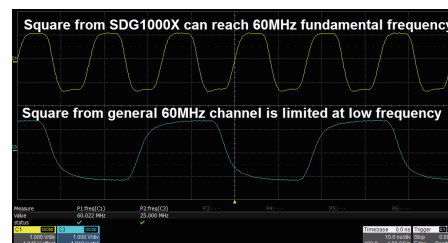
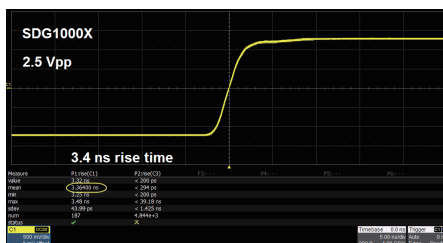
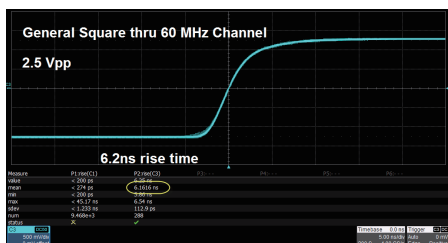

Benefiting from a special square-wave generating circuitry, the Square from the SDG1000X breaks the 60 MHz bandwidth barrier, reaching rise/fall times of less than 4.2 ns, and frequencies up to 60 MHz.

▶ The Square wave exhibits the same excellent jitter performance as the Pulse waveform.

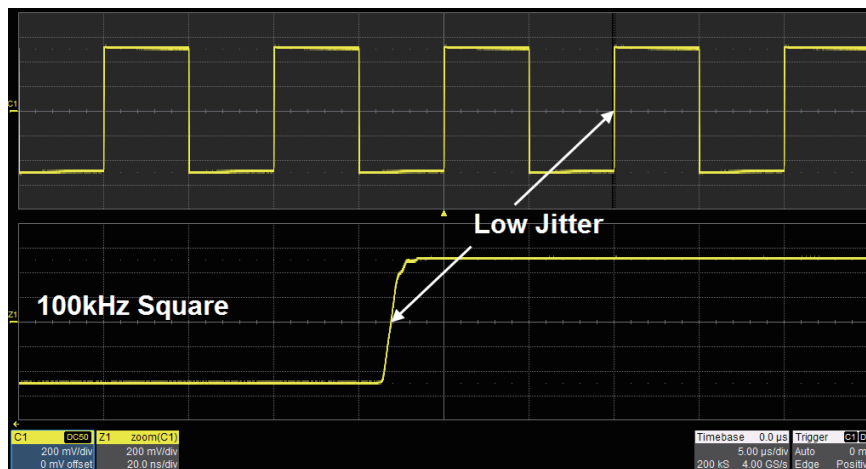

## Characteristics

### • Modulation

The screenshot shows the Modulation menu for two channels, both set to Sine wave with a 50Ω load. Channel 1 is labeled "CH1:Sine.ON.50Ω" and Channel 2 is "CH2:Sine.ON.50Ω". The settings for both are: Frequency 1.000 000kHz, Amplitude 4.000 Vpp, Offset 0.000 Vdc, and Phase 0.00°. Channel 1 has AM Depth set to 120.0% and AM Freq set to 100.000 000 Hz. The Load is 50 Ω and Output is ON. The menu includes tabs for Type (AM), Source (Internal), AM Depth, Shape (Sine), and AM Freq.

Multiple modulation types: AM, DSB-AM, FM, PM, FSK, ASK, PSK and PWM. The modulation source can be configured as "Internal" or "External".

### • Harmonics Function

The screenshot shows the Harmonics Function menu. It features a graph of the waveform and a graph of the Harmonic Order (H) vs. Harmonic Amplitude (A). The settings are: Frequency 1.000 000kHz, Amplitude 4.000 Vpp, Offset 0.000 Vdc, Phase 0.00°, Harm Type All, Harm Order 3, Harm Ampl 800.0mVpp, and Harm Phase 0.00°. The menu includes tabs for Type, Order, Harmonic Ampl, Harmonic Phase, and Cancel.

Up to 10 harmonics may be generated. Amplitude and phase of each harmonic can be set independently.

### • Frequency Counter

The screenshot shows the Frequency Counter menu. It displays a table of measurement statistics for a 10.000 000MHz reference frequency. The table includes columns for Value, Frequency, Pwidth, Duty, and Freq Dev. The Ref Freq is set to 10.000 000MHz. The menu includes tabs for State (On), Frequency (Period), Pwidth (Nwidth), RefFreq (TrigLev), Setup, and Clear.

Value	Frequency	Pwidth	Duty	Freq Dev
9.999 980 2MHz	50.5ns	50.5 %	-1.981ppm	
9.999 980 7MHz	50.4ns	50.4 %	-1.928ppm	
9.999 979 8MHz	39.2ns	39.2 %	-2.021ppm	
9.999 982 3MHz	61.9ns	61.9 %	-1.767ppm	
515.388 20MHz	2.4ns	2.4 %	0.049ppm	
46	46	46	46	

High precision Frequency Counter with an input frequency range of 0.1 Hz~200 MHz.

### • Waveform Combining

The screenshot shows the Wave Combine menu. It features a diagram of two channels (CH1 and CH2) being combined into a single output (CH1+CH2). The menu includes tabs for CH1 Switch, CH2 Switch, CH1+CH2, CH2, and Return.

Capable of combining the waveforms of 2 channels from internal, providing more flexible tools to generate complex waveforms.

## Ordering Information

Product Description	
30 MHz, 2 CH, 150 MSa/s, 14 bit	SDG1032X
60 MHz, 2 CH, 150 MSa/s, 14 bit	SDG1062X
Standard configurations	
Quick Start -1	
Power Cord-1	
Calibration Certificate -1	
USB Cable -1	
Optional configurations	
BNC Coaxial Cable	SDG-BNC
20 dB Attenuator	ATT-20dB
USB-GPIB Adapter	USB-GPIB



## SDG800 *Easy Pulse* Function/Arbitrary Waveform Generator

### Application

- Simulate sensor
- Simulate environmental signal
- Circuit function test
- IC chip test
- Research and education

### Key Features

- Advanced DDS technology, 125 MSa/s sampling rate, 14 bit vertical resolution
- Single channel output, 5 kinds of standard waveforms, built-in 46 kinds of arbitrary waveforms (including DC)
- Complete modulation functions: AM, DSB-AM, FM, PM, FSK, ASK, PWM, linear/logarithmic sweep and burst
- Innovative EasyPulse technology, can output pulse of low jitter, quick rising/falling edge
- Standard interfaces: USB Device, USB Host, support U-Disk storage and software update
- Provide 10 nonvolatile storage spaces for user's arbitrary waveforms
- Be capable of seamlessly connected to SIGLENT Digital Storage Oscilloscope
- Configurable with powerful arbitrary waveform editing software EasyWave



## Specifications

Model	SDG805	SDG810	SDG830
Maximum output frequency	5 MHz	10 MHz	30 MHz
Output channels	1		
Sampling rate	125 MSa/s		
Wave length	16 kpts		
Frequency resolution	1 $\mu$ Hz		
Vertical resolution	14 bit		
Waveform	Sine, Square, Ramp, Pulse, Gaussian white noise, Arbitrary waveform, 46 types of built-in arbitrary waveforms		
Sine wave	1 $\mu$ Hz ~ 5 MHz	1 $\mu$ Hz ~ 10 MHz	1 $\mu$ Hz ~30 MHz
Square wave	1 $\mu$ Hz ~ 5 MHz	1 $\mu$ Hz ~ 10 MHz	1 $\mu$ Hz ~10 MHz
Pulse	500 $\mu$ Hz ~ 5 MHz	500 $\mu$ Hz ~ 5 MHz	500 $\mu$ Hz ~5 MHz
Ramp/Triangular	1 $\mu$ Hz ~ 300 kHz	1 $\mu$ Hz ~ 300 kHz	1 $\mu$ Hz ~ 300 kHz
Gaussian white noise	>5 MHz bandwidth (-3 dB)	>10 MHz bandwidth (-3 dB)	>30 MHz bandwidth (-3 dB)
Arbitrary waveform	1 $\mu$ Hz ~ 5 MHz	1 $\mu$ Hz ~ 5 MHz	1 $\mu$ Hz ~ 5 MHz
Modulation function	AM, FM, PM, DSB-AM, FSK, ASK, PWM, Sweep, Burst		
Standard configuration	USB Host & USB Device		
Amplitude (high impedance)	4 mVpp~20 Vpp ( $\leq$ 10 MHz) 4 mVpp~10 Vpp ( $>$ 10 MHz)		

# SPS5000X

## Programmable Switching DC Power Supply



### Main Features

- Rated Output Voltage: 40 V, 50 V, 80 V, 160 V
- Rated Output Power: 180 W, 360 W, 720 W, 1080 W
- Wide range of output voltage and current, high efficiency power supply
- CV, CC priority mode selection, better protection of equipment under test
- Load transient recovery time (Load change from 50~100%) <1 ms
- Adjustable slew rate of output voltage and current
- Setting and readback resolution: 1 mV, 1 mA
- User enabled internal output discharge circuit to accelerate the down programming of the output voltage
- Remote Voltage Sensing
- List function up to 50 steps; can be created from the front panel or by importing list sequence files from a USB memory device
- External analog voltage and resistor control of voltage or current output
- External voltage and current monitoring output
- OVP, OCP, LPP, OTP protection.
- 2.4-inch OLED high brightness liquid crystal display, 170-degree viewing angle
- Standard Interface: USB, LAN, Analog Control Interface
- Optional Interface: USB-GPIB module
- 1/2, 1/3, 1/6 rack mount size
- Embedded Web Server offers remote control through a web browser without the need for the driver or software

## Design Features

### • Constant Output Power

In constant output power mode, the voltage and current range is switched automatically to maximize the voltage and current without sacrificing the supply's output power. This mode enables the supply to provide a higher output voltage at lower current and a higher output current at lower voltage. Compared to the traditional rectangular output range of most supplies, the SPS5000X series power supply provides a wider voltage and current output range, which greatly increases the utilization of the power supply.

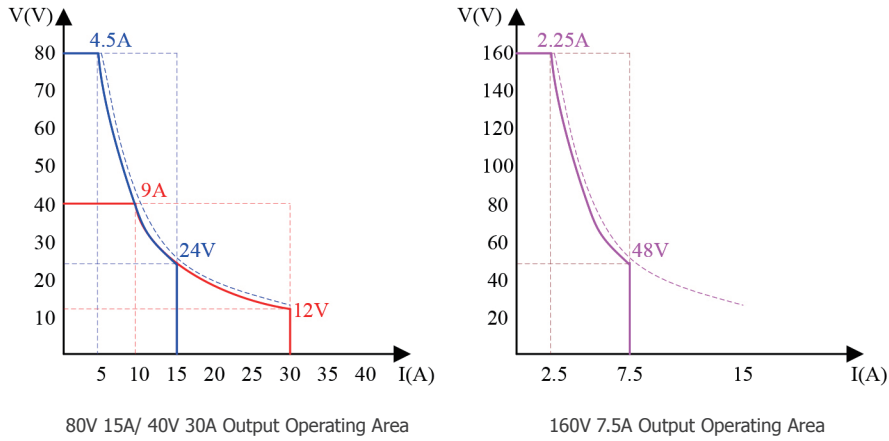

### • Adjustable Output Voltage, Current up/down Slew Rate

The SPS5000X series supports custom setting of the rise/fall slew rate of voltage/current to verify the performance of the object under test as the voltage/current changes. This feature can effectively prevent the damage caused by inrush current to the DUT in applications such as the testing of capacitive current absorbing devices.

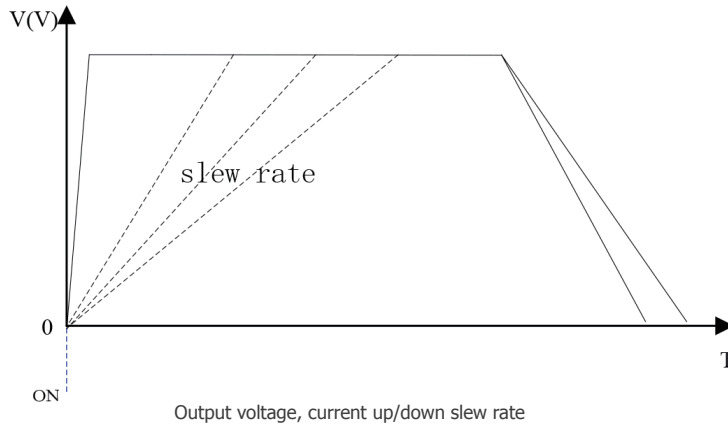

### • CV/CC Priority Mode

When the SPS5000X series power supply is set to CC priority mode, at the power output-on stage, it is able to operate under CC priority to limit the inrush current spike and overshoot voltage effectively when the power output is turned on.

In CV priority mode, the output voltage reaches the set voltage value quickly. In some applications, such as LED testing, when the power output is started, the surge current and overshoot voltage will appear when the voltage reaches the on-state voltage of the LEDs.



CV priority mode



CC priority mode

### • Intuitive List Operation Function

By editing the single-step setting value, duration, and slew rate, the List function can generate multiple complex sequences to meet complex test requirements. The user can edit the sequence by 50 steps natively or import the List sequence file via USB for multi-step running. The minimum precision of delay time is 1ms. The minimum running time is 1 second.

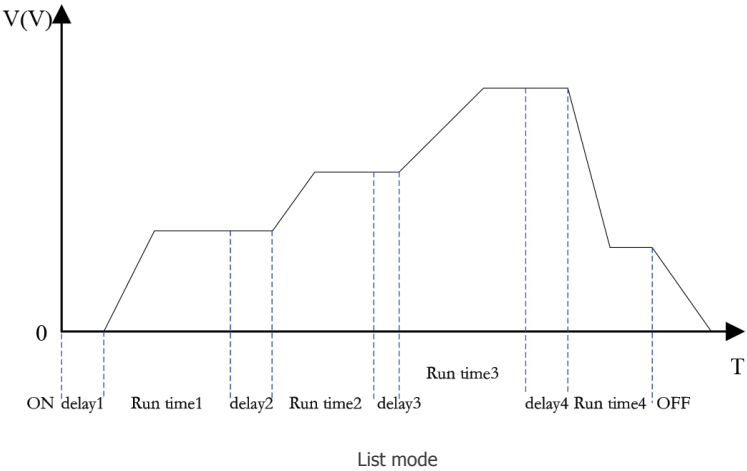

### • Rich Interface

The power supply includes USB and Ethernet communication interfaces as standard, and a USB-GPIB converter module as optional. The embedded Web Server enables control and monitor of the power supply directly from a web browser, eliminating the need to install software drivers or applications.

	State	Voltage(V)	Current(A)	Power(W)	Channel Enabled	List	Vset(V)	Iset(A)	Output
CH1	CV	29.991	0.000	0.005	<input checked="" type="checkbox"/>	<input type="checkbox"/>	30	6	<span style="color: green;">ON</span>
CH2	CC	0.000	0.000	0.000	<input type="checkbox"/>	<input type="checkbox"/>	0	0	
CH3	CC	0.000	0.000	0.000	<input type="checkbox"/>	<input type="checkbox"/>	0	0	

Step	Vset(V)	Iset(A)	Delay Time(s)	Running Time(s)	Slope(V/s)	Operation
1	3	4	3	3	3	Delete
2	3	3	2	3	3	Delete
3	2	2	2	2	4	Delete
4	3	3	3	1	1	Delete
5	2	3	3	1	1	Delete
6	3	2	1	3	1	Delete
7	3	2	2	4	1	Delete
8	2	2	3	3	1	Delete
9	3	2	2	2	2	Delete
10	1	3	3	2	2	Delete

Web Server Interface

### Specifications

Model	SPS5041X	SPS5042X	SPS5043X	SPS5044X	SPS5045X	units
Output channel	1			2	3	CH
Rated output voltage	40					V
Rated output current	30	60	90	30		A
Total rated output power	360	720	1080	720	1080	W
Power Ratio	3.33					

# DC Power Supply

Model	SPS5051X	SPS5081X	SPS5082X	SPS5083X	SPS5084X	SPS5085X	units
Output channel	1	1			2	3	CH
Rated output voltage	50	80					V
Rated output current	10	15	30	45	15		A
Total rated output power	180	360	720	1080	720	1080	W
Power Ratio	2.77	3.33					
Model	SPS5161X	SPS5162X	SPS5163X	SPS5164X	SPS5165X	units	
Output channel	1			2	3	CH	
Rated output voltage	160					V	
Rated output current	7.5	15	22.5	7.5		A	
Total rated output power	360	720	1080	720	1080	W	
Power Ratio	3.33						

## Ordering Information

Product information	Product No	
40 V/30 A 360 W	Single channel programmable Switching DC Power supply	SPS5041X
40 V/60 A 720 W	Single channel programmable Switching DC Power supply	SPS5042X
40 V/90 A 1080 W	Single channel programmable Switching DC Power supply	SPS5043X
40 V/30 A 360 W X2	Dual Channel Programmable Switching DC Power supply	SPS5044X
40 V/30 A 360 W X3	Three Channel Programmable Switching DC Power supply	SPS5045X
50 V/10 A 180 W	Single channel programmable Switching DC Power supply	SPS5051X
80 V/15 A 360 W	Single channel programmable Switching DC Power supply	SPS5081X
80 V/30 A 720 W	Single channel programmable Switching DC Power supply	SPS5082X
80 V/45 A 1080 W	Single channel programmable Switching DC Power supply	SPS5083X
80 V/15 A 360 W X2	Dual Channel Programmable Switching DC Power supply	SPS5084X
80 V/15 A 360 W X3	Three Channel Programmable Switching DC Power supply	SPS5085X
160 V/7.5 A 360 W	Single channel programmable Switching DC Power supply	SPS5161X
160 V/15 A 720 W	Single channel programmable Switching DC Power supply	SPS5162X
160 V/22.5 A 1080 W	Single channel programmable Switching DC Power supply	SPS5163X
160 V/7.5 A 360 W X2	Dual Channel Programmable Switching DC Power supply	SPS5164X
160 V/7.5 A 360 W X3	Three Channel Programmable Switching DC Power supply	SPS5165X
Standard Accessories		
USB Cable -1		
Quick Start -1		
Calibration Certificate -1		
Power Cord -1		
Output guard -1		
Optional Accessories		
SPS5000X-SEC	SPS5000X Series cable	
SPS5000X-PAC	SPS5000X Parallel cable	
SPS5000X-RMK	SPS5000X EIA Standard rack	

# SPD3000

## Programmable Linear DC Power Supply



### Application

- R&D lab general purpose testing
- Teaching lab experiment
- Automotive electronic test
- Production testing and quality assessment inspection

### Key Features (SPD3303X/SPD3303X-E)

- 3 independent controlled and isolated output, 32 V/3.2 A $\times$ 2, 2.5 V/3.3 V/5 V/3.2 A $\times$ 1, total 220 W
- Max 5 digits Voltage, 4 digits Current Display, Minimum Resolution: 1 mV/1 mA
- Supports panel timing output functions
- 4.3 inch true color TFT- LCD 480 $\times$ 272 display
- 3 types of output modes: independent, series, parallel
- 100 V/120 V/220 V/230 V compatible design to meet the needs of different power grids.
- Intelligent temperature-controlled fan , effectively reducing noise
- Clear graphical interface, with the waveform display function
- Internal 5 groups of system parameter save/recall, supports data storage space expansion
- Provides PC software: Easypower , supports SCPI , LabView driver

### Key Features (SPD3303C)

- 3 independent high precision output: 32 V/3.2 A $\times$ 2, 2.5 V/3.3 V/5 V/3.2 A $\times$ 1, total 220 W
- 4 digits voltage and 3 digits current display, min resolution: 10 mV, 10 mA
- Three output modes: independent, series and parallel
- 100 V/120 V/220 V/230 V compatible design, to meet the need of different power grids
- Smart temperature controlled fan, effectively reduce the noise
- Save/Recall 5 group system specifications, support data storage expansion
- Connected to PC via USB Device, support SCPI command, to meet the control and communication needs

## Specifications

Model	SPD3303C	SPD3303X-E	SPD3303X
Channels	CH1: DC voltage range: 0-32 V, DC current range: 0-3.2 A		
	CH2: DC voltage range: 0-32 V, DC current range: 0-3.2 A		
	CH3: DC voltage range: 2.5/3.3/5.0 V, DC current range: 0-3.2 A		
Max output power	220 W		
Resolution	10 mV / 10 mA		1 mV / 1 mA
Display digits	LED display 4 digits voltage 3 digits current	4.3 inch TFT-LCD display 4 digits voltage 3 digits current	4.3 inch TFT-LCD display 5 digits voltage 4 digits current
Ripple noise	CV/CH3: $\leq 1$ mVrms (5 Hz~1 MHz) CC: $\leq 3$ mArms		
Standard interface	USB Device	USB Device, LAN	
Dimension	225 mm (W)×136 mm (H)×275 mm (D)		
Weight	7.5 kg (SPD3303C) 8 kg (SPD3303X/X-E)		

### Panel displays the timing output

Through front panel operation, 5 groups of timing settings and output control can be displayed, which provides users a simple power programming function. Also a connection can be made with Siglent's EasyPower PC software providing a full range of communication and control requirements.

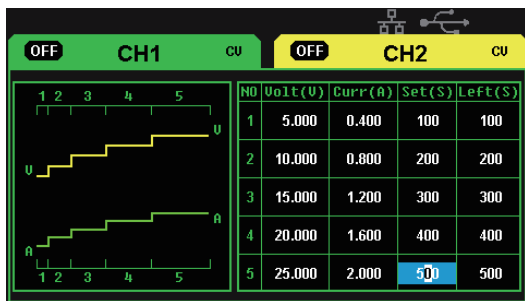

Panel timing output

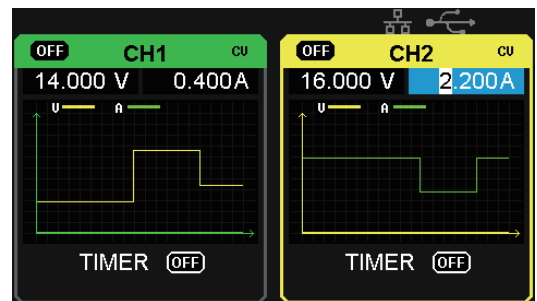

Real time wave display

### Save/Recall setting parameters

SPD3000X series programmable power supply can save or recall 5 groups of setting parameter in internal storage, also supports external storage expansion. You can easily obtain the settings you needed.

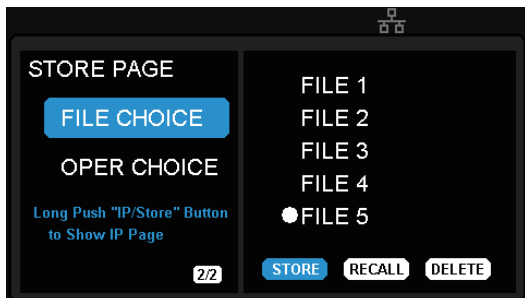

Internal Storage

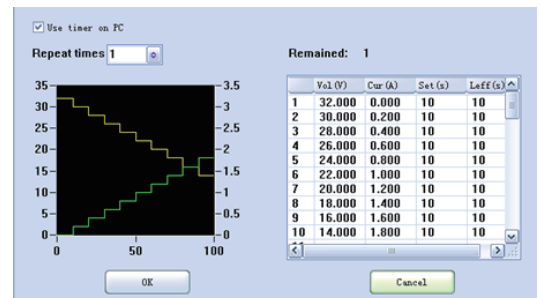

PC Timer



## SPD1000X Programmable Linear DC Power Supply

### Main Features

- Single path high-precision programmable voltage output:
  - 16 V/8 A, total power up to 128 W
  - 30 V/5 A, total power up to 150 W
- Stable, reliable, Low ripple and noise:  $\leq 350 \mu\text{Vrms}/3 \text{ mVpp}$ ;  $< 2 \text{ mArms}$
- Fast transient response time:  $< 50 \mu\text{s}$
- 5 digit Voltage, 4 digit Current Display, Minimum Resolution: 1 mV/1 mA
- Supports front panel timing output functions
- 2.8 inch true color TFT- LCD 240 \*320 display
- 2 types of output modes: Two-wire output mode, 4-wire compensation output mode, Maximum compensation voltage 1 V
- 100/120/220/230 V compatible design to meet the needs of different power grids
- Intelligent temperature-controlled fan reduces noise
- Clear graphical interface, with the waveform display function
- Internal 5 groups of system parameter save/recall
- Includes PC software: Easypower, supports SCPI, LabView driver



## Design Features

- **High-resolution and high-precision output**

The SPD1000X power supply features a high measurement resolution of 1 mV/1 mA . This ensures accurate output even with very small changes in voltage or current. This is impossible for a low resolution power supply.

- **4-wire SENSE compensation mode function**

In the 4-wire SENSE compensation output mode: By using a separate measurement circuit, the supply can more accurately compensate for any voltage drops due to high resistance connections or long cables. Maximum compensation voltage is 1 V.

- **Low ripple and noise**

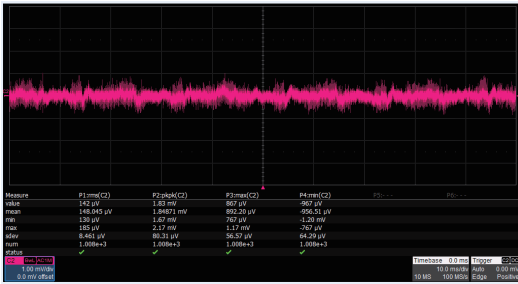

- **Fast transient response time**

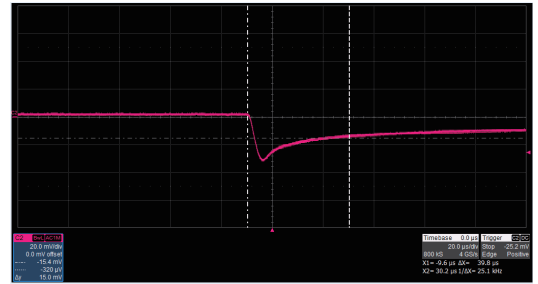

- **Low voltage overshoot**

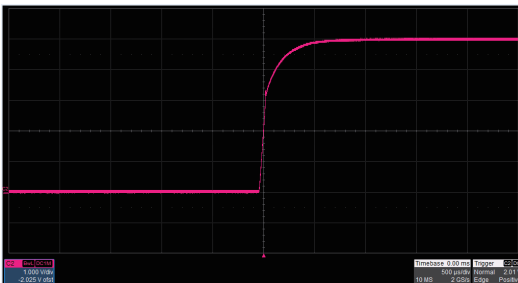

- **0.01% Load Regulation & 0.2% Line Regulation**



- **Panel displays the timing output**

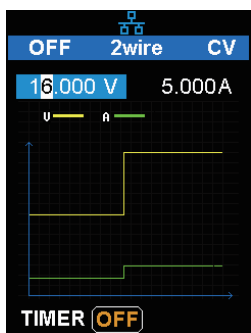

Panel timing output

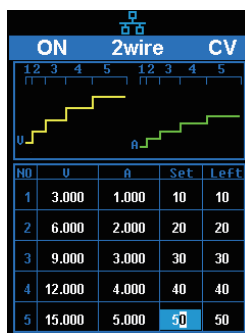

Real time wave display

- **Save/Recall setting parameters**

SPD1000X programmable power supply can save or recall 5 groups of setting parameters in internal storage. You can easily recall the settings you need.

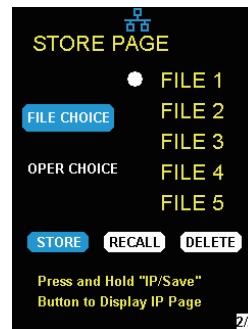

Internal Storage

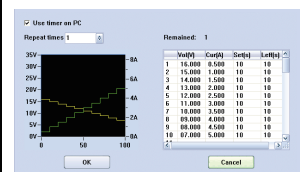

PC Timer

## Specifications

All the specifications are guaranteed when the instrument has been working for more than 30 minutes under the specified operating temperature. Unless otherwise noted, the specifications are applicable to all the channels of the specified model.

Model		SPD1168X	SPD1305X
DC Output (0 °C to 40°C )		Output Voltage: 0 to 16 V Output Current: 0 to 8 A	Output Voltage: 0 to 30 V Output Current: 0 to 5 A
Display		2.8 inch true color TFT-LCD 5 digit voltage/4 digit current	
Resolution		1 mV/1 mA	
Program Accuracy (25 ± 5 °C )		Voltage: ±(0.03% of reading+10 mV)	
		Current: ±(0. 3% of reading+10 mA)	
Program Accuracy (25 ± 5 °C )		Voltage: ±(0.03% of reading+10 mV)	
		Current: ±(0. 3% of reading+10 mA)	
Temperature Coefficient per °C (Output Percentage + Offset)		Voltage: ±(0.01% of reading+3 mV)	
		Current: ±(0.01% of reading+3 mA)	
Constant Voltage Mode	Load Regulation	≤ 0.01% + 2 mV	
	Ripple & Noise	≤ 350 uVrms/3 mVpp (20 Hz to 20 MHz)	
	Recovery Time	< 50 μs (50% load change, minimum load 0.5 A)	
Constant Current Mode	Line Regulation	≤ 0.2% + 3 mA	
	Load Regulation	≤ 0.2% + 3 mA	
	Ripple & Noise	≤ 2 mArms	
Locking Key		Yes	
Memory Save/Recall		5 Sets	
Max Output Power		128 W	150 W
Power Source		AC 100 /120/220/230 V ± 10% 50/60 Hz	
Standard Configuration Interface		USB Device, LAN	
Insulation		Case to Terminal ≥ 20 MΩ (DC 500 V) Case to AC line ≥ 30 MΩ (DC 500 V)	
Operating Environment		Outdoor Usage: Elevation: ≤2000 m Environment Temperature 0 to 40 °C Relative Humidity ≤ 80% Installation Level: II Pollution Level: 2	
Storage Environment		Environment Temperature: -10 to 70 °C Relative Humidity ≤ 70%	
Dimension		154.6 (W) × 144.5 (H) × 280(D) mm	
Weight		≈5.5 kg	



## SDL1000X Series Programmable DC Electronic Load

### Main Feature

- SDL1020X (Single channel ): DC 150 V/30 A, total power up to 200 W
- SDL1030X (Single channel ): DC 150 V/30 A, total power up to 300 W
- 4 static modes / Dynamic mode: CC/CV/CR/CP
- CC Dynamic mode: Continuous, pulsed, toggled
- CC Dynamic mode: 25 kHz, CP Dynamic mode: 12.5 kHz, CV Dynamic mode: 0.5 Hz
- Measuring speed of voltage and current: up to 500 kHz
- Adjustable current rise time range: 0.001 A/us~2.5 A/us
- Min. readback resolution: 0.1 mV, 0.1 mA
- Short-circuit, Battery test, CR-LED mode, and factory test functions
- 4-wire SENSE compensation mode function
- List function supports editing as many as 100 steps
- Program function supports 50 groups of steps
- OCP, OVP, OPP, OTP and LRV protection
- External analog control
- Voltage, Current monitoring via 0-10 V
- 3.5 inch TFT-LCD display, capable of displaying multiple parameters and states simultaneously
- Built-in RS232/USB/LAN communication interface, USB-GPIB module (optional)
- Waveform trend chart and ease-to-use file storage and call functions
- Includes PC software: Supports SCPI, LabView driver

## Design Features

### Steady state operating mode

The SDL features four operating modes to provide flexible test capabilities. In CC mode, the electronic load will sink a constant current, regardless of the voltage at its terminals. In CV mode, the electronic load will cause a constant voltage to appear at its terminals. In CR mode, the electronic load will behave as a fixed resistance value. As shown in the figure, the electronic load will linearly change the current according to the input voltage. In CP mode, the electronic load will cause a constant power to be dissipated in the load.

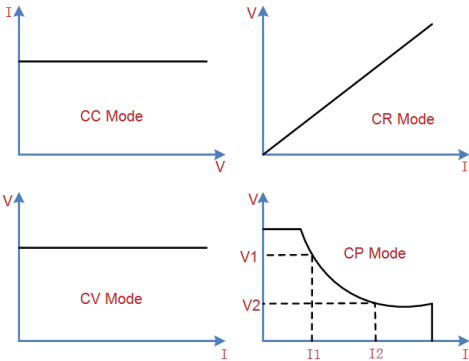

### Dynamic test mode up to 25 kHz (CC)

The transient test allows switching between two different load values. A common application is to test the dynamic characteristics of a DC source or DUT (Device Under Test). The transient test function enables the load to periodically switch between two set levels (Level A and Level B). The highest frequency can be set to 25 kHz in CC mode. The highest frequency can be set to 12.5 kHz in CP modes.

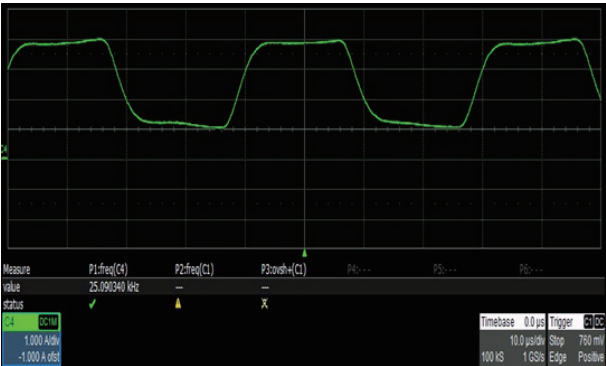

### Simplify complex sequencing using the list operation function

You can generate complex load sequences quickly using the list operation function. Here, you can edit the setpoints, dwell time, and slew rate for each step in the test. \*Slew rate can only be edited in CC mode.

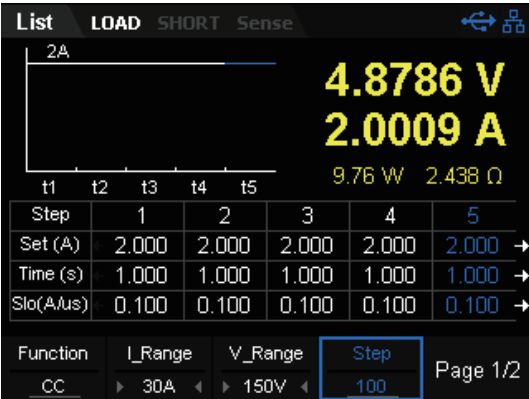
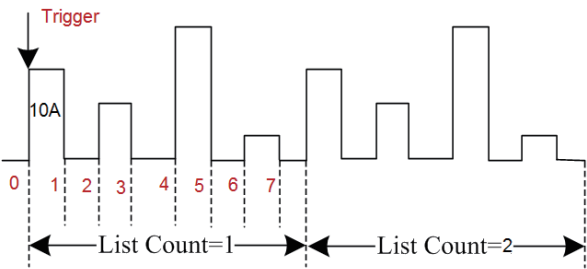

### 4-wire SENSE compensation mode function

In CC/CV/CR/CW mode, when a load is connected to a power supply, it will cause a large voltage-drop on the connection lines between tested instrument and terminals of load. Using remote sense, you can measure the voltage at the DUTs input terminals, effectively removing the additional error due to the voltage drop in the connection wires.

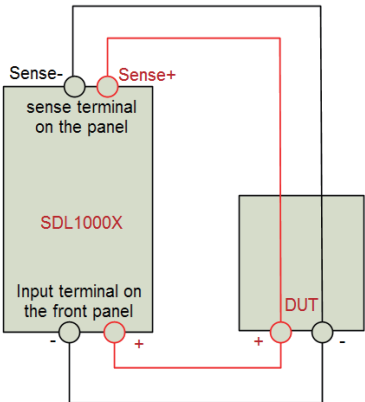

## • Program function

In program (auto-test) mode, you can generate a sequence of tests using different modes, mode parameters and durations. This function is useful for automatically executing a set of tests on a device then display whether the tests passed or failed. Test results are easily viewed by pressing the up and down buttons. The load provides 8 nonvolatile registers to save auto-test file for recall later. Each file contains 1-50 steps to set up. Auto-test function is especially useful in the designing battery charging circuitry.

step	1	2	3	4	5
mode	CC	CC	CC	CC	CC
Irange	30A	30A	30A	30A	30A
Vrange	150V	150V	150V	150V	150V
paus	OFF	OFF	OFF	OFF	OFF
short	OFF	OFF	OFF	OFF	OFF
Ton	10.000s	1.000s	1.000s	1.000s	1.000s
Toff	1.000s	1.000s	1.000s	1.000s	1.000s
Tdly	1.000s	1.000s	1.000s	1.000s	1.000s

Step	Storage	Trig	Result
5			

## • Battery discharge function

The SDL1000X can also provide insight into battery performance by analyzing the discharge characteristics of the DUT. The SDL features three stop conditions for the discharge test: Voltage, capacity or time. The discharge process is immediately terminated if the stop conditions are met. This provides more control over the test termination and an extra layer of safety during critical tests. Throughout the test process the battery voltage, discharge current, discharge time and discharged capability is displayed clearly on the LCD panel.

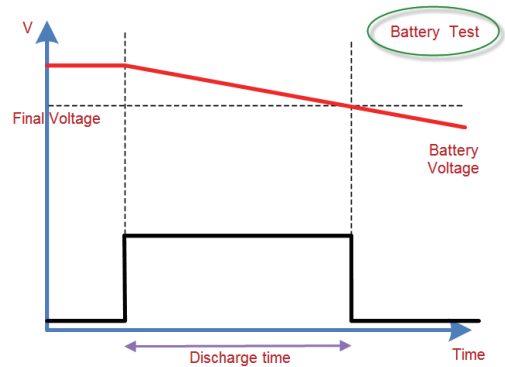

## • OCPT/OPPT Mode

Over-current protection (OCPT) mode prevents drawing too much current from the DUT. After the input voltage reaches the Von point, the DC load will start to draw a current from the source after a delay time. The current value will increase by a certain step size at regular intervals. Simultaneously, the DC load will compare the input voltage to the OCP voltage: If it is lower, then the present current value will be compared to see if it is in the current range you have set. Within the range, the OCP test will evaluate Pass or Fail. If it is outside of the set range, the DC load will increase drawing current and compare the voltage again.

OCPT	LOAD	SHORT	Sense
4.9395 V	0.9973 A		
4.93 W	4.952 Ω		

I_Range	V_Range	OCP_V	I_Step	Page 1/3
30A	150V	1.00V	1.000A	

## • CR-LED Mode

The SDL1000X includes a CR-LED mode specifically for LED driver testing. Basing on the traditional CR mode, CR-LED mode adds a diode break-over voltage setting. When the input voltage is above this set value, the DC load start to work. Thus, it can emulate the actual characteristics of an LED.

LED	LOAD	SHORT	Sense
4.7505 V	0.8566 A		
4.07 W	5.501 Ω		

  

I_Range	V_Range	Io	Vo	Rco
30A	150V	1.000A	5.00V	0.2000

Overpower-protection (OPPT) mode: When the input voltage has reached the Von point, the load will draw power after a delay time. The power value will increase by a step size at regular intervals. Simultaneously, the DC load will judge whether the input voltage is lower than OPP voltage you have set, if it is, then the present current value will be compared to see if it is in the current range you have set. Within the range, the OPP test will Pass or Fail. If it is outside of the set power, the load will continue to increase the power draw within the cut-off current range and compare OPP voltage with the input.

## • Voltage Rise/Fall speed test

The electronic load is also equipped to directly measure voltage rise and fall times. It can calculate the time from one voltage to another without the need for additional measurement instrumentation. With an SDL1000X, you can save money and improve efficiency.

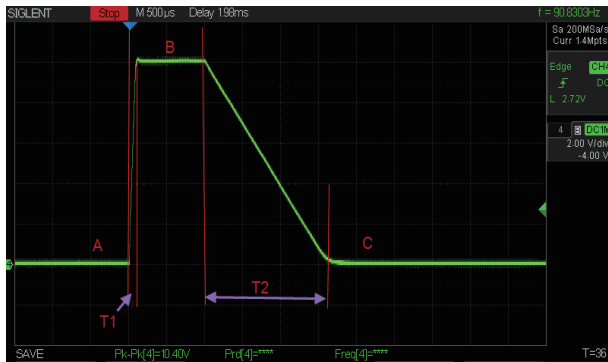

## • Waveform trend chart function

The electronic load includes a waveform display function and supports the following operations for the waveform: Pause, recording, and capturing the waveform. You can quickly observe the trends of parameter changes as they occur throughout the test.

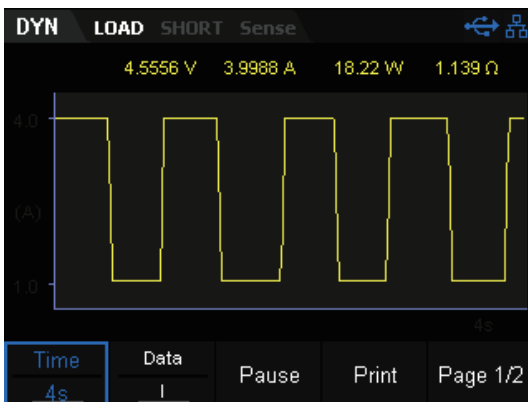

## • External analog control

The load allows the user to control current or voltage through external analog terminals (EXT PRG). Input a 0-10 V analog to adjust 0-100% rated voltage and current. It is very useful for those applications that need to change the input value with external signals.

## • Voltage threshold function

The SDL1000X can be set to turn on or off if the input voltage is at, above, or below a set value. By defining these thresholds, you control when the load is active. Which minimizes test time and increases safety.

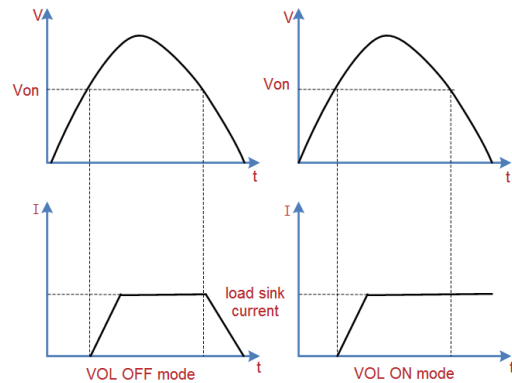

## • Save/Recall setting parameters

The load allows you to save different types of files to the internal and external memories. You can recall and read them when necessary.

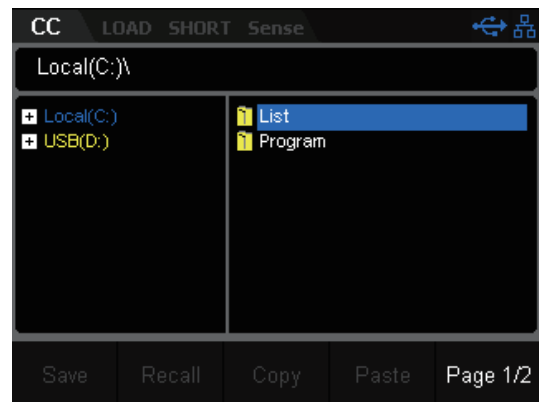

## • Multiple protection modes

The SDL1000X series Programmable DC Electronic Load provides five protection types: OVP, OCP, OPP, OTP and LRV. When OVP/OCP/OPP/OTP/reverse voltage protection (LRV) occurs, the load will immediately turn off the input and stop sinking. Then, a prompt message is displayed.



## SDM3065X Digital Multimeter

### Application

- Research Laboratory
- Development Laboratory
- Detection and Maintenance
- Calibration Laboratory
- Automatic Production Test

### Main Feature (SDM3065X/SDM3065X-SC)

- 4.3" TFT-LCD, 480\*272
- Real 6½ digits readings resolution (2,200,000 counts)
- 1Gb Nand flash size, Mass storage configuration files and data files
- True-RMS AC Voltage and AC Current measuring
- Supports double display, Chinese and English Menu
- File management (support for U-disc and local storage)
- Built-in cold terminal compensation for thermocouple
- Comes with easy, convenient and flexible any sensor measurement control software: EasyDMM
- Standard interfaces: USB Device, USB Host, LAN (Optional Accessories: USB- GPIB Adapter )
- Scanner Card SC1016 (Only for SDM3065X-SC)
- Built-in Help system makes information acquisition easier
- Support remote control operation via SCPI commands. Compatible with commands of other main stream multimeters
- Supports intelligent management system for laboratory based on BS framework and LAN

## Special Features

- Histogram

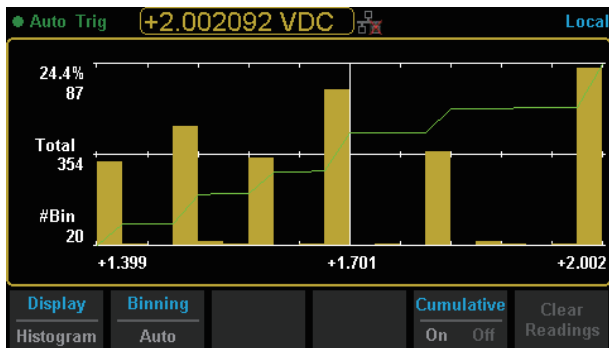

- Trend Chart

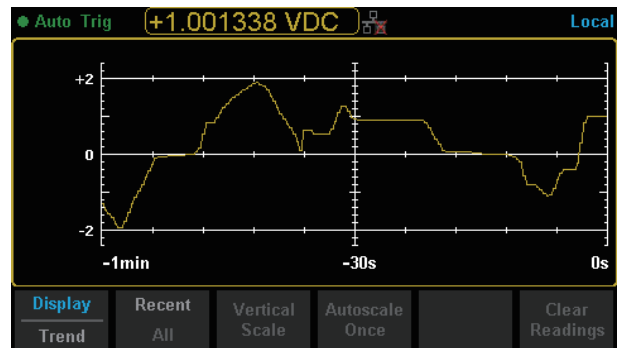

- "Analog" Bar Display

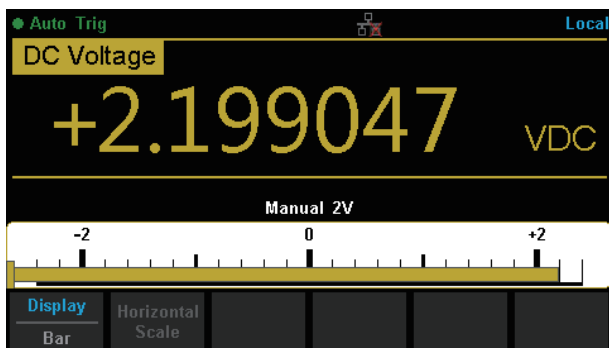

- Statistics

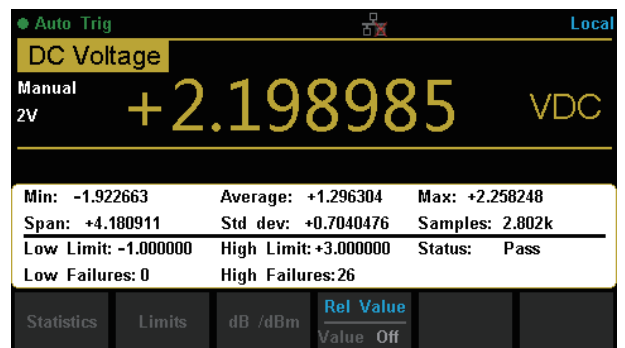

- Dual Measurement Display

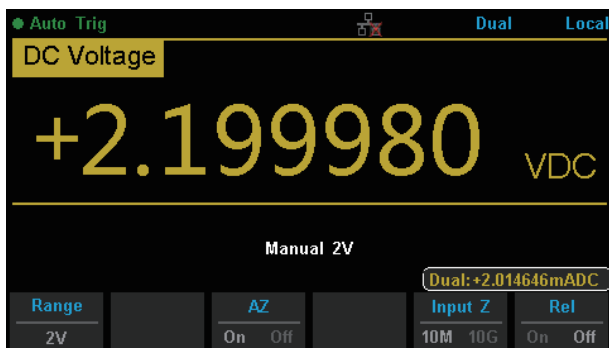

- Hold Measurement

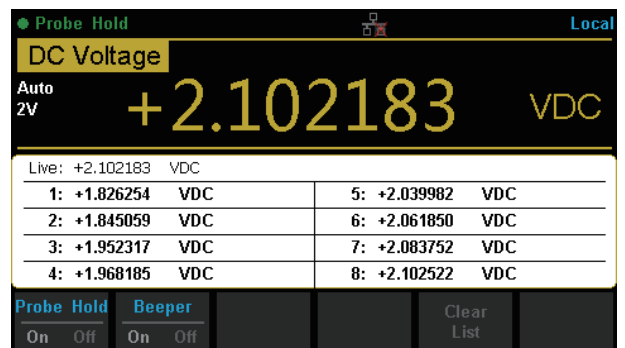

- dBm Hold Measurement

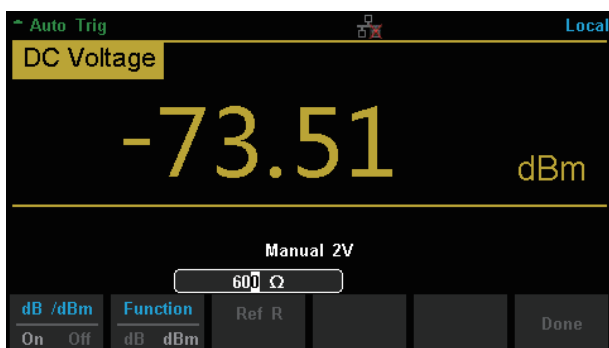

- Interface





## Scanner card SC1016 (Only for SDM3065X-SC)

The SIGLENT Scanner Card SC1016 is a multiplexer that provides multi-point measurement capabilities to the SDM3065X-SC. The scanner features 12 multi-purpose + 4 current channels and supports the following measurement functions: DCV, ACV, DCI, ACI, 2WR, 4WR, CAP, FREQ, DIODE, CONT and TEMP (RTD and Thermocouple). It provides a convenient and versatile solution for test applications that require multiple measurement points or signals and is an ideal tool for R&D burn-in and production testing.

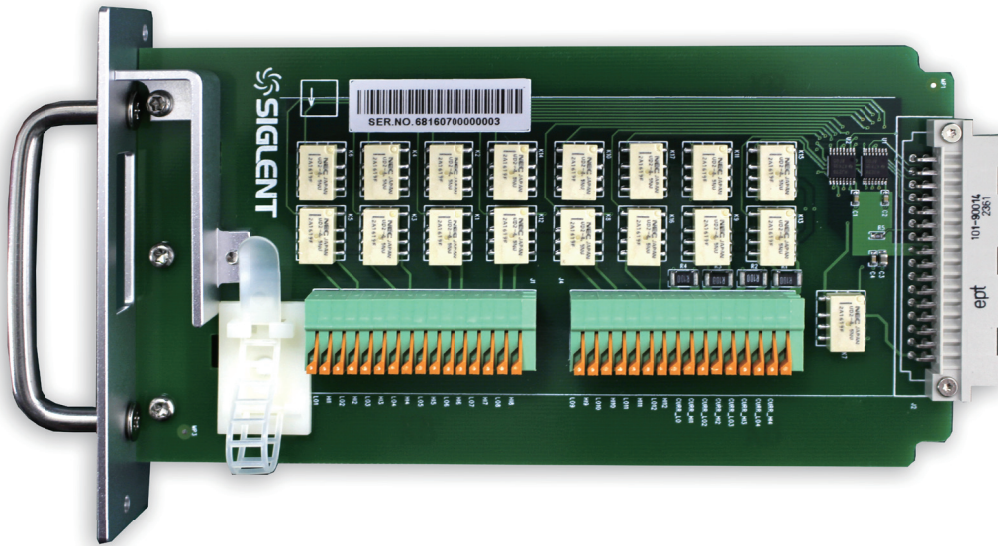

## Ordering Information

Standard Accessories	
Power Cord -1	
USB Cable -1	
Quick Start -1	
warranty Card -1	
EasyDMM <sup>[1]</sup>	software
Test Leads and Alligator Clips -2	
Optional Accessories	
USB-GPIB	USB-GPIB adapter

[1]The latest version of EasyDMM can be downloaded for free from the SDM3000 series of digital multimeter. Please see our web site at [www.siglent.com](http://www.siglent.com) for more information.



## SDM3055 Digital Multimeter

### Application

- Research & Development Laboratory
- Detection and Maintenance
- Calibration Laboratory
- Automatic Production Test

### Main Features (SDM3055/SDM3055-SC)

- Real 5½ digits readings resolution ( 240, 000 counts )
- Up to 150 rdgs/s measurement speed
- True-RMS AC Voltage and AC Current measuring
- 1 Gb Nand flash size, Mass storage configuration files and data files
- Built-in cold terminal compensation for thermocouple temperature measurements
- With easy, convenient and flexible PC software: EasyDMM
- standard interfaces: USB Host, LAN ( Optional Accessories USB-GPIB Adapter )
- Scanner Card SC1016 ( Only for SDM3055-SC )
- Support remote control operation via SCPI commands. Compatible with commands of main stream multimeters

## Special Features

### • Histogram

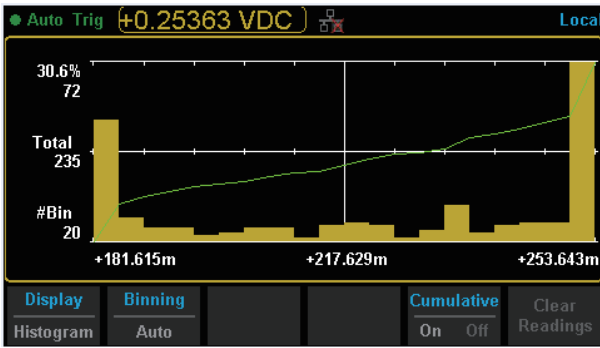

### • Trend Chart

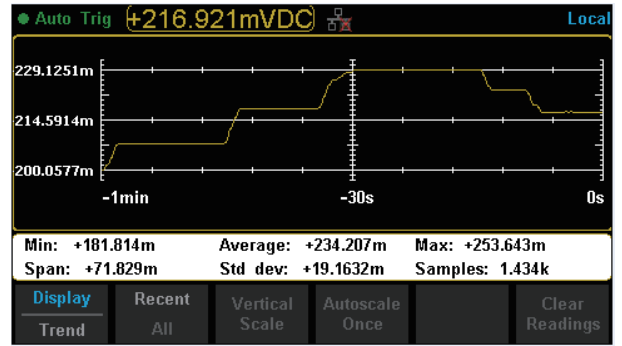

### • Bar Chart

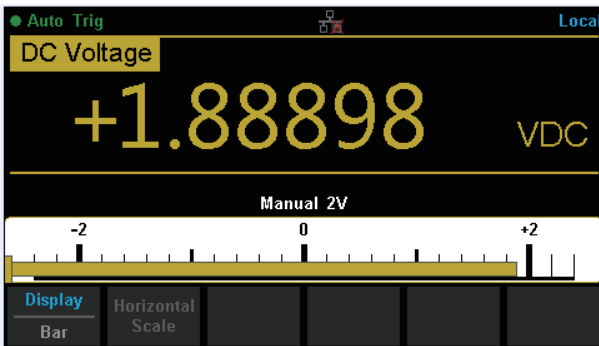

### • Statistics

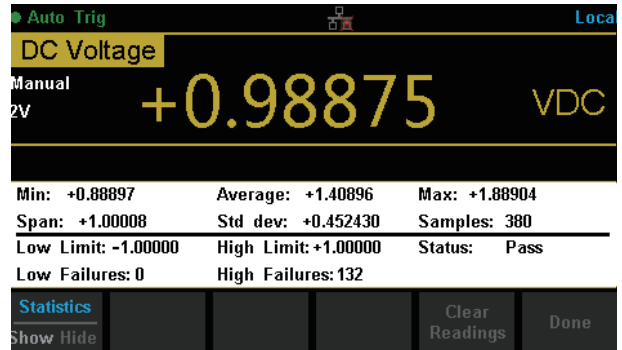

### • Dual Display

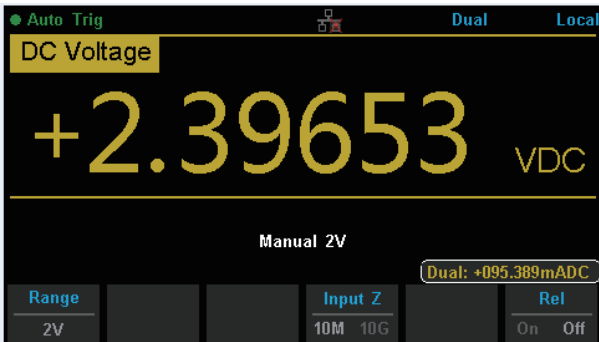

### • Hold Measurement

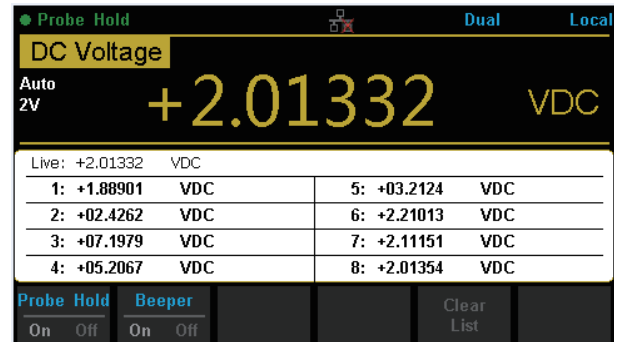

### • dBm Hold Measurement

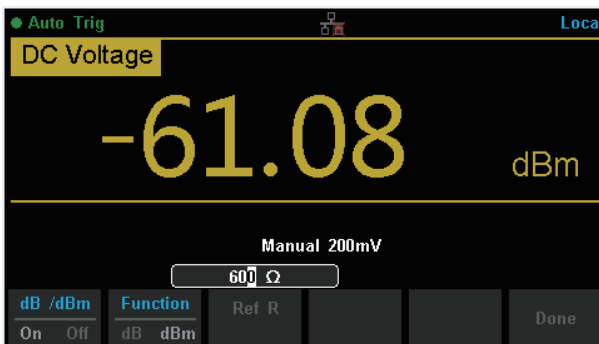

### • Interface



## Scanner card SC1016 ( Only for SDM3055-SC )

The SIGLENT Scanner Card SC1016 is a multiplexer that provides multi-point measurement capabilities to the SDM3055-SC. The scanner features 12 multi-purpose + 4 current channels and supports the following measurement functions: DCV, ACV, DCI, ACI, 2WR, 4WR, CAP, FREQ, DIODE, CONT and TEMP ( RTD and Thermocouple ). It provides a convenient and versatile solution for test applications that require multiple measurement points or signals and is an ideal tool for R&D burn-in and production testing.

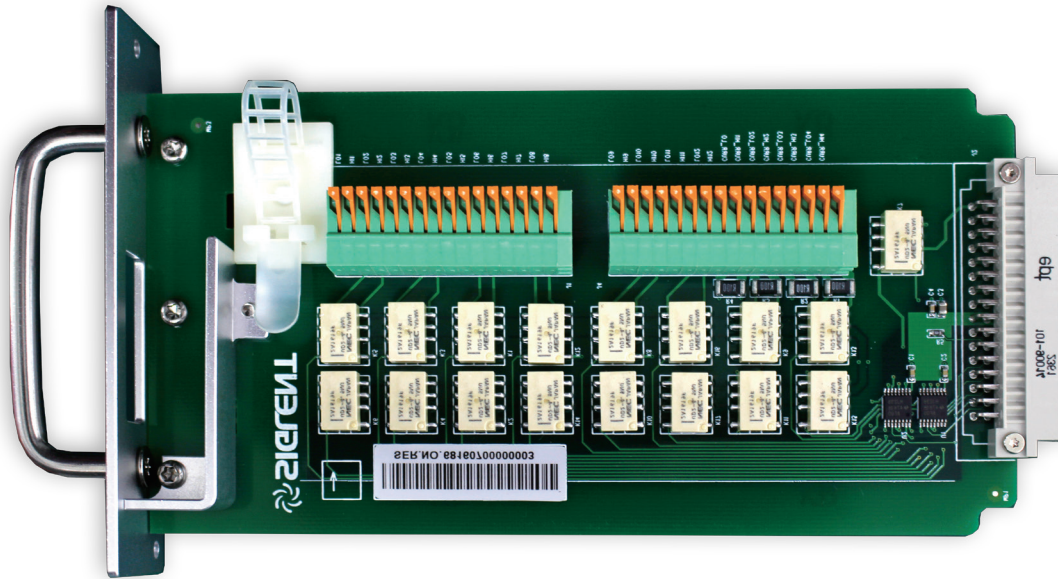

## Ordering Information

Standard Accessories	
Power Cord -1	
USB Cable -1	
Quick Start -1	
warranty Card -1	
EasyDMM <sup>[1]</sup>	software
Test Leads and Alligator Clips -2	
Optional Accessories	
USB-GPIB	USB-GPIB adapter

[1]The latest version of EasyDMM can be downloaded for free from the SDM3000 series of digital multimeter. Please see our web site at [www.siglent.com](http://www.siglent.com) for more information.



## SDM3045X Digital Multimeter

### Application

- Research Laboratory
- Development Laboratory
- Detection and Maintenance
- Calibration Laboratory
- Automatic Production Test

### Main Features SDM3045X

- Real 4½ digit (60000 count) readings resolution
- Up to 150 rdgs/s measurement speed
- True-RMS AC Voltage and AC Current measuring
- 1 Gb NAND flash size, Mass storage configuration files and data files
- Built-in cold terminal compensation for thermocouple
- With easy, convenient and flexible PC software: EasyDMM
- Standard interface: USB Device, USB Host, LAN (Optional Accessories: USB-GPIB Adapter)
- USB & LAN remote interfaces support common SCPI command set. Compatible with other popular DMMs on the market

## Special Features

### • Histogram

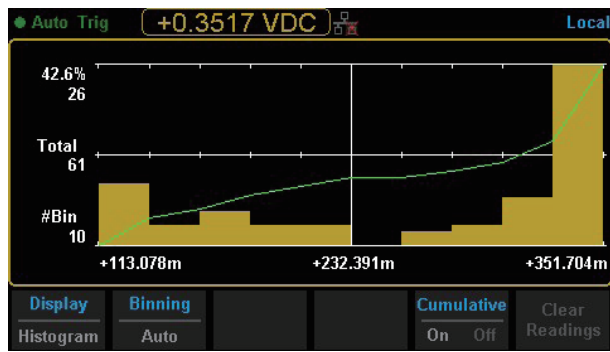

### • Trend Chart

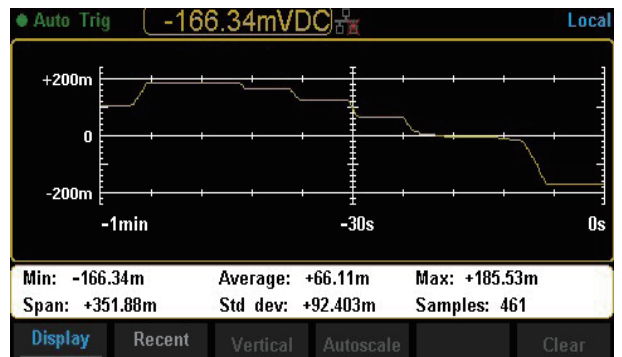

### • Bar Chart

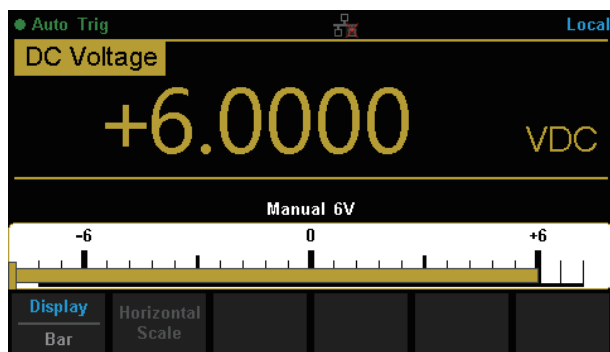

### • Statistics

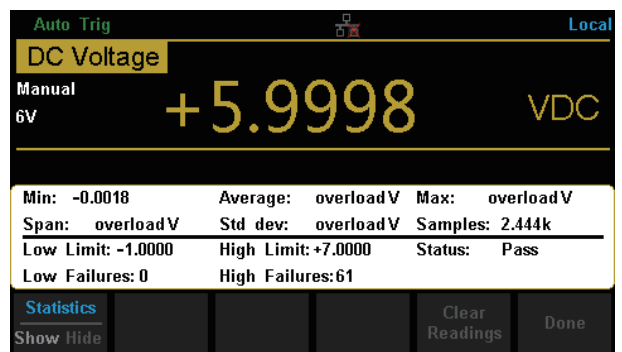

### • Dual Display

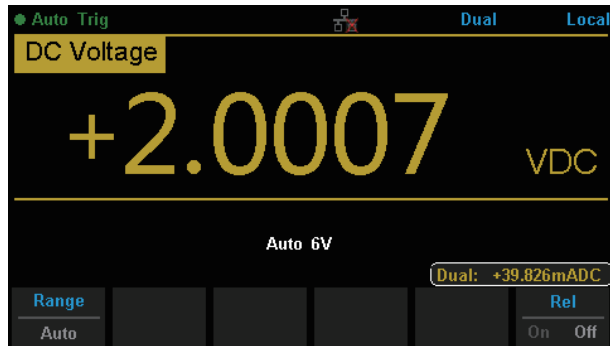

### • Hold Measurement

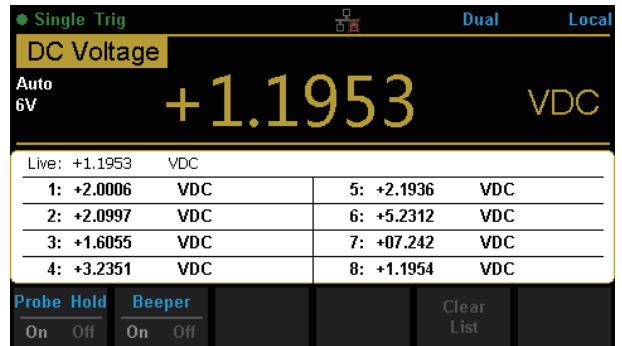

### • dBm Hold Measurement

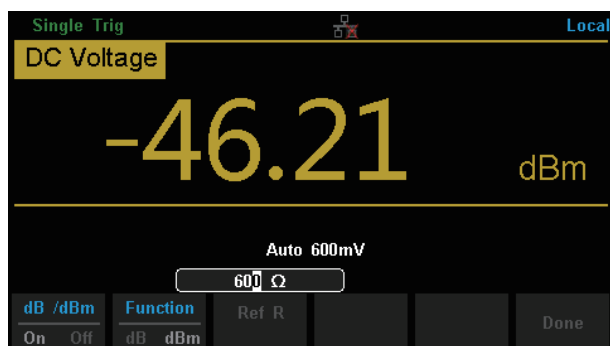

### • Interface

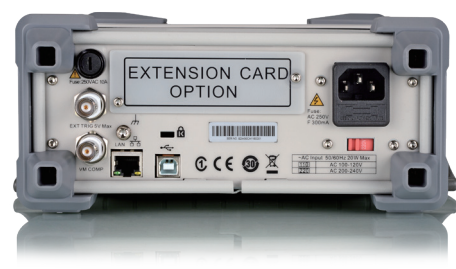











## Ordering Information











Standard Accessories	
Power Cord -1	
USB Cable -1	
Quick Start -1	
warranty Card -1	
EasyDMM <sup>[1]</sup>	software system
Test Leads and Alligator Clips -2	
Optional Accessories	
USB-GPIB adapter	USB-GPIB











[1] The latest version of EasyDMM can be downloaded for free from the SDM3000 series of digital multimeter. Please see our web site at [www.siglent.com](http://www.siglent.com) for more information.

# Probes and Accessories



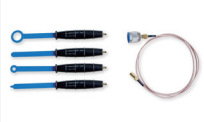

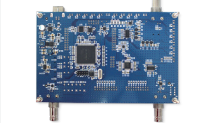
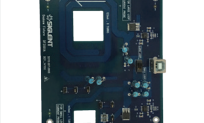



Type	Model	Picture	Specifications
Passive Probe	PB470 PP510 PP215		PB470, 70 MHz bandwidth PP510, 100 MHz bandwidth PP215, 200 MHz bandwidth 1 X/10 X decay, 1 M/10 Mohm, 300 V/600 V
	PB925		Bandwidth 250 MHz, fixed 10X decay, the rise time of about 1.2 ns, input capacitance: 16 pF, compensation range: 10 pF-35 pF, input impedance 10 MΩ, length 120 cm, safe voltage levels: CAT II 1000 V, CAT III 600 V
Active Probe	SAP1000		Bandwidth(-3dB) 1GHz, input capacitance 1.2 pF, input impedance 1MΩ, DC bias range ±12V, probe attenuation factor ÷10, DC bias accuracy <3%, DC gain accuracy <3%, input dynamic range ±8V, non-destructive voltage range 20 V, length 130 cm
	SAP2500		Bandwidth(-3dB) 2.5 GHz, input capacitance 1.1 pF, input impedance 1MΩ, DC bias range ±12V, probe attenuation factor ÷10, DC bias accuracy <3%, DC gain accuracy <3%, input dynamic range ±8V, non-destructive voltage range 20 V, length 130 cm
	SAP2500D		Bandwidth(-3dB) 2.5 GHz, input capacitance 1.0 pF, input impedance 200 kohm(Diff), 100 kohm(Single ended), 50 kohm(Comm mode), DC bias range ±8 V, probe attenuation factor ÷10, DC bias accuracy <3%, DC gain accuracy <3%, input dynamic range ±8V, differential input dynamic range ±4 V, common mode input range ±10 V, non-destructive voltage range 20 V, length 130 cm
	SAP5000D		Bandwidth(-3dB) 5 GHz, input capacitance 400 fF, input impedance 20 kohm(Diff), 10 kohm(Single ended), 50 kohm(Comm mode), DC bias range ±12 V, probe attenuation factor ÷10, DC bias accuracy <3%, DC gain accuracy <3%, input dynamic range ±8V, differential input dynamic range ±2.5 V, , non-destructive voltage range 20 V, length 130 cm
Current Probe	CPL5100		Bandwidth: DC-600 kHz; Current range L, H; Maximum operation current 10 A(L)/ 100 A(H); Max operation voltage 600 V ; DC Accuracy: 3%±50 mA (L) ; 1500 mA~40 A Peak: 4%±50 mA; 40 A~100 A Peak: ±15% Maximum (H); 9 V alkaline layer-built battery/ 15 H
	CP4020		Bandwidth : 200 kHz; Maximum continuous current 20 Arms; Peak current 60 A; Switching ratio: 50 mV/A; 5 mV/A; DC measurement accuracy: 50 mV/A (0.4 A-10 ApK) ± 2%; 5 mV/A (1 A-60 ApK)±2%; 9 V battery-powered
	CP4050		Bandwidth: 1 MHz; Maximum continuous current 50 Arms; Peak current 140 A; Switching ratio: 500 mV/A; 50 mV/A; DC measurement accuracy: 500 mV/A (20 mA-14 ApK) ±3%±20 mA; 50 mV/A (200 mA-100 ApK )±4%± 200 mA; 50 mV/A (100 A-140 ApK)±15% max; 9V battery-powered
	CP4070		Bandwidth: 300 kHz; Maximum continuous current 70 Arms; Peak current 200 A; Switching ratio: 50 mV/A; 5 mV/A; DC measurement accuracy: 50 mV/A (0.4 A-10 ApK) ±2%, 5 mV/A (1 A-200 ApK)±2%;9 V battery-powered
	CP4070A		Bandwidth: 300 kHz; Maximum continuous current 70 Arms; Peak current 200 A; Switching ratio: 100 mV/A;10 mV/A; DC measurement accuracy: 100 mV/A (50 mA-10 ApK) ±3%±50 mA; 10 mV/A (500 mA-40 ApK) ±4%±50 mA; 10 mV/A (40 A-200 ApK) ±15% max; 9 V battery-powered



Type	Model	Picture	Specifications
<b>Current Probe</b>	SCP5030		Bandwidth: 50 MHz; Maximum continuous current 30 Arms; Peak current 50 A; Switching ratio: 5 A/30 A; Accuracy: 5 A( $\pm 1\% \pm 1$ mA); 30 A( $\pm 1\% \pm 10$ mA); Powered by oscilloscope via SAPBUS
	SCP5030A		Bandwidth: 100 MHz; Maximum continuous current 30 Arms; Peak current 50 A; Switching ratio: 5 A/30 A; Accuracy: 5 A( $\pm 1\% \pm 1$ mA); 30 A( $\pm 1\% \pm 10$ mA); Powered by oscilloscope via SAPBUS
	SCP5150		Bandwidth: 12 MHz; Maximum continuous current 150 Arms; Peak current 300 A; Switching ratio: 30 A/150 A; Accuracy: 30 A( $\pm 1\% \pm 10$ mA); 150 A( $\pm 1\% \pm 100$ mA); Powered by oscilloscope via SAPBUS
	SCP5500		Bandwidth: 2 MHz; Maximum continuous current 500 Arms; Peak current 750 A; Switching ratio: 75 A/500 A; Accuracy: 75 A( $\pm 1\% \pm 10$ mA); 500 A( $\pm 1\% \pm 100$ mA); Powered by oscilloscope via SAPBUS
	CP6030		Bandwidth: 50 MHz; Maximum continuous current 30 Arms; Peak current 50A; Switching ratio: 5 A/30 A; Accuracy: 5A( $\pm 1\% \pm 1$ mA); 30A( $\pm 1\% \pm 10$ mA); Standard DC12V/1A power adapter
	CP6030A		Bandwidth: 100 MHz; Maximum continuous current 30 Arms; Peak current 50 A; Switching ratio: 5 A/30 A; Accuracy: 5 A( $\pm 1\% \pm 1$ mA); 30 A( $\pm 1\% \pm 10$ mA); Standard DC12 V/1 A power adapter
	CP6150		Bandwidth: 12 MHz; Maximum continuous current 150 Arms; Peak current 300 A; Switching ratio: 30 A/150 A; Accuracy: 30 A( $\pm 1\% \pm 10$ mA); 150 A( $\pm 1\% \pm 100$ mA); Standard DC12 V/1 A power adapter
	CP6500		Bandwidth: 5 MHz; Maximum continuous current 500 Arms; Peak current 750 A; Switching ratio: 75 A/500 A; Accuracy: 75 A( $\pm 1\% \pm 10$ mA); 500 A( $\pm 1\% \pm 100$ mA); Standard DC12 V/1 A power adapter
<b>High Voltage Differential Probe</b>	DPB1300		Bandwidth: DC-50 MHz, Rise time $\leq 7$ ns; DC Accuracy $\pm 2\%$ ; Attenuation Ratio 50 X/500 X; Max Differential Test Voltage (DC + Peak AC) 50 X: $\pm 130$ V, 500 X: $\pm 1300$ V; DC 12 V/1.2 A Power
	DPB4080		Bandwidth: 50 MHz; Maximum input differential voltage 800 V (DC + Peak AC); Range selection (attenuation ratio): 10 X/100 X; Accuracy: $\pm 1\%$ ; Standard DC 9 V/1 A power adapter
	DPB5150		Bandwidth: 70 MHz; Maximum input differential voltage 1500 V (DC + Peak AC); Range selection (attenuation ratio): 50 X/500 X; Accuracy: $\pm 2\%$ ; Standard 5 V/ 1 A USB power adapter

Type	Model	Picture	Specifications
High Voltage Differential Probe	DPB5150A		Bandwidth: 100 MHz; Maximum input differential voltage 1500 V (DC + Peak AC); Range selection (attenuation ratio): 50 X/500 X; Accuracy: $\pm 2\%$ ; Standard 5 V/ 1 A USB power adapter
	DPB5700		Bandwidth: 70 MHz; Maximum input differential voltage 7000 V (DC + Peak AC); Range selection (attenuation ratio): 100 X/1000 X; Accuracy: $\pm 2\%$ ; Standard 5 V/1 A USB power adapter
	DPB5700A		Bandwidth: 100 MHz; Maximum input differential voltage 7000 V (DC + Peak AC); Range selection (attenuation ratio): 100 X/1000 X; Accuracy: $\pm 2\%$ ; Standard 5 V/1 A USB power adapter
High Voltage Probe	HPB4010		Bandwidth: 40 MHz; Maximum measurement voltage DC: 10 KV; AC(rms): 7 KV (sine); AC (Vpp): 20 KV (Pulse); attenuation ratio: 1:1000; Accuracy: $\leq 3\%$
Logic Probe	SLA1016		16 logic analyzer hardware module, suitable for SDS1000X-E 4 channel series and SDS2000X-E series oscilloscope
	SPL2016		Logic Probe for SDS2000X, SDS2000X Plus and SDS5000X series, 16-channel, 500 MSa/s
Near-field Probe	SRF5030T		Near Field Probe: H field probe sets (20 mm, 10 mm, 5 mm) , E field probe (5 mm), 300 kHz~3.0 GHz; distinguished within 10 cm range of the magnetic field; for EMI radiation interference and the intensity detector
GPIB	USB-GPIB		The USB Device interface extends into the GPIB interface, USB-GPIB adapter can more easily complete the task of the operation command through the GPIB, USB follow the USB2.0 specification, GPIB follow the IEEE488.2 standard
Demo Board (STB Test Board)	STB3		Output signals include square waves, sine, AM, pulse, PWM, fast edge, I2C, CAN, LIN signal etc
Deskew Fixture	DF2001A		Supporting power analysis software for calibration phase voltage and current probes generated during transmission
PC Software	SigIQPro		A comprehensive PC-based software for general and standards-based signals creation, supporting Bluetooth, IoT, Custom OFDM, etc.
	SigScopeLab		A professional time-domain signal analysis and oscilloscope control software running on the Windows operating system

Type	Model	Picture	Specifications
<b>Rack Mount</b>	SDS1X-E-RMK		Rackmount kit , compatible with the SDS800X HD,SDS1000X-E,SDS1000X-U,SDS2000X-E model; Height 4U
	SDG-RMK		Single instrument rack mount kit 19" shelf design is compatible with the SDG800, SDG1000, SDG1000X, SDG2000X, SDG6000X, and SDG5000 series function generators as well as the SDM3000 series of DMMs
	SDG-2-RMK		Rackmount kit for two instruments , compatible with the SDG800, SDG1000, SDG1000X, SDG2000X, SDG5000 and SDG6000X series function generator and SDM3045X, SDM3055, SDM3065X digital multimeter
	SPD3000-RMK		Compatible with SPD3000X / X-E / D / S / C models.4U rack height
	SDS5000X-RMK		Rack Mount kit for SDS5000X; Height 6U
	SDS6000-RMK		Rack Mount kit for SDS6000A, SNA5000A, SSA5000A; Height 7U
	SDS2000-RMK		Rackmount kit is designed for use with only one instrument, is compatible with the SDS2000, SDS2000X, SDS2000X Plus series Oscilloscope; Height 6U
	SDS2000HD-RMK		Rack Mount kit for SDS1000X HD,SDS2000X HD,SDS3000X HD; Height 6U (exactly 260 mm)
	SPS5000X-RMK		SPS5000X EIA Standard rack, height 3U
<b>Amplifier</b>	SPA1010		Increase the voltage and current output capabilities to generators like the SIGLENT SDG family. Typical Input Impedance: 15kΩ Input: +/- 6.5V Vpp (Gain: X1) +/- 1.3 V (Gain: X10) Gain: Switched 10V/1V and 10V/10V Output Voltage: 25.4 Vpp Output Current: 1.12 A Slew Rate: ≥ 90 V/μs Overshoot: ≤ 4% Compatible with all SIGLENT SDG series generators
<b>Current Plug-in</b>	SCD30A		Digital multimeter 30A current shunt-1mV/A, DC ~ 1 kHz ±0.3%, 1 kHz ~ 5 kHz ±5%, 30Vac RMS MAX, 60 Vdc MAX (only compatible with SDM series multimeters which are 4 1/2 or above)
<b>Attenuator</b>	ATT-20 dB		20dB attenuator

Type	Model	Picture	Specifications
Test fixture	FX-USB2		USB 2.0 test fixture
	FX-ETH		100Base-TX & 1000Base-T compliance test fixture
	FX-AMETH		100Base-T1 & 1000Base-T1 compliance test fixture
USB AWG Module	SAG1021I		Output Sine, Square, Ramp, pulse, Noise, DC and 45 built-in waveforms. The arbitrary waveforms can be accessed and edited by the EasyWave PC software. Isolated voltage $\pm 42$ Vpk.
Carry Bag	BAG-S1		Soft Carry Case for SDS1000DL+/CML+, SDS1000X, SDS1000X-E, SDS2000X-E Series
	BAG-S2		Soft Carry Case for SDS2000X, SDS5000X, SSA3000X, SVA1000X, SSA3000X Plus
	BAG-H1		Soft Carry Case for SHS800X/SHS1000X
Cover	FC1		Protective Cover for SNA5000A, SDS6000A

## Other Products Overview

SIGLENT also provides other instruments like Spectrum Analyzer, Vector Network Analyzer, RF/MW Signal Generator

### ※ Spectrum Analyzer ※



	SSA5000A	SSA3000X-R	SVA1000X	SSA3000X Plus	SHA850A
Frequency Range	9 kHz ~ 13.6/26.5 GHz	9 kHz ~ 3.2/5/7.5 GHz	9 kHz ~ 1.5/3.2/7.5 GHz	9 kHz ~ 1.5/2.1/3.2/7.5 GHz	9 kHz ~ 3.6/7.5 GHz
Real-Time Spectrum Analysis	○	√	×	×	×
Tracking Generator	×	√	√	○	○
Vector Network Analyzer	×	√	√	×	○
EMI Measurement	×	○	○	○	○
SSB Phase Noise	<-105 dBc/Hz	<-99 dBc/Hz	<-98 dBc/Hz	<-98 dBc/Hz	<-104 dBc/Hz
Displayed Average Noise Level	-165 dBm/Hz	-165 dBm/Hz	-165 dBm/Hz	-165 dBm/Hz	-165 dBm/Hz
Signal Modulation Analysis	○	○	○	○	○
Cable and antenna testing	×	○	○	×	√
Advanced Measurement Kit	○	○	○	○	○
Remote Control Capability	√	√	√	√	√
Touch Screen	12.1"	10.1"	10.1"	10.1"	8.4"

√: Standard ○: Option ×: Not Support

## ※ Vector Network Analyzer ※



	SNA5000A	SHN900A	SHA850A	SVA1000X	SSA3000X-R
Vector Network Analyzer Frequency Range	9 kHz ~ 4.5/8.5 GHz 100 kHz ~ 13.5/26.5 GHz	30 kHz ~ 14/20/26.5 GHz	100 kHz ~ 3.6/7.5 GHz	100 kHz ~ 1.5/3.2/7.5 GHz	100 kHz ~ 3.2/5/7.5 GHz
Port	2/4	2-path-2-port	1-path-2-port	1-path-2-port	1-path-2-port
Spectrum Analyzer Frequency Range	9 kHz ~ 4.5/8.5 GHz 100 kHz ~ 13.5/26.5 GHz	30 kHz ~ 14/20/26.5 GHz	9 kHz ~ 3.6/7.5 GHz	9 kHz ~ 1.5/3.2/7.5 GHz	9 kHz ~ 3.2/5/7.5 GHz
Level resolution	0.05 dB	0.01 dB	-	-	-
Range of IFBW	10 Hz~3 MHz	10 Hz~3 MHz	10 kHz	10 kHz	10 kHz
Setting range of output level	-55 dBm ~+10 dBm	-45 dBm ~ + 10 dBm	-40 dBm ~ 0 dBm	-20 dBm ~ 0 dBm	-20 dBm ~ 0 dBm
Dynamic range	125 dB	100 dB	114 dB	90 dB	90 dB
Types of calibration	Response calibration, Enhanced Response calibration, Full-one port calibration, Full-two port calibration, TRL calibration	Response calibration, Enhanced Response calibration, Full-one port calibration, Full-two port calibration, TRL calibration	Short Response, Open Response, Full 1-Port(OSL), Response Through, Enhanced Response	Short Response, Open Response, Full 1-Port(OSL), Response Through, Enhanced Response	Short Response, Open Response, Full 1-Port(OSL), Response Through, Enhanced Response
Types of measurement	Scattering parameter measurement, differential parameter measurement, receiver measurement, time-domain parameter analysis, limit test, ripple test, impedance conversion, fixture simulation, adapter removal/insertion, spectrum analysis frequency offset, scalar mixer measurement		S11, S21	S11, S21	S11, S21
TDR	○	○	√	×	×
Bias-Tees	√	√	√	×	×
Remote control	√	√	√	√	√
Touch screen	12.1"	8.4"	8.4"	10.1"	10.1"

√: Standard ○: Option ×: Not Support

## ※ RF/MW Signal Generator ※



	SSG6000A	SSG5000A	SSG5000X	SSG3000X
Frequency range (CW MODE)	100 kHz ~ 13.6/20/40 GHz	9 kHz ~ 13.6/20 GHz	9 kHz ~ 4/6 GHz	9 kHz ~ 2.1/3.2 GHz
Frequency range (IQ MODE)	×	×	10 MHz ~ 4/6 GHz	10 MHz ~ 2.1/3.2 GHz
Internal modulation generator	×	×	√	×
Frequency setting resolution	0.01 Hz	0.001 Hz	0.001 Hz	0.01 Hz
Amplitude resolution	0.01 dB	0.01 dB	0.01 dB	0.01 dB
Total amplitude accuracy	≤ 0.7 dB	≤ 0.7 dB	≤ 0.7 dB	≤ 0.7 dB
SSB phase noise (offset 20 kHz@ 1 GHz)	-135 dBc/Hz	-120 dBc/Hz	-120 dBc/Hz	-110 dBc/Hz
Level setting range	-130 dBm ~ 24 dBm	-130 dBm ~ 20 dBm	-140 dBm ~ 26 dBm	-110 dBm ~ 20 dBm
Custom digital modulation mode	×	×	√	×
ARB mode	×	×	√	×
Pulse generator	○	○	○	○
Pulse train generator	○	○	○	○
Pulse modulation	○	○	√	√
Power meter control kit	√	√	√	√
Remote control	√	√	√	√
Touch screen	5"	5"	5"	5"

√: Standard ○: Option ×: Not Support

## Service Promise:

Since the date of purchase, we offer three year's warranty for the main unit:

- During the warranty period, if the products cause any hardware or software failure because of the quality, Siglent's after-sales service center or Siglent's designated maintenance points will offer the maintenance of the fault products for the user.
- Because of improper use or any other artificial reason, the damage won't be included in the free maintenance.

## 1. Extension after-sales service

Extension service is based on the main unit (not including accessories) as an object. During the extension service, Siglent still offer free maintenance after the standard warranty period.

### 1.1 Three advantages:

- Guarantee investment. To extend the life cycle of the products.
- Save money. To prevent the high cost of maintenance after the warranty period.
- Avoid the repeated investment. To prevent buying new equipments because it can't be repaired after the warranty period.

### 1.2 The content of the extension service

You can buy the following extension service according to your demand:

Solution	Viability	Instruction
ES4	One year after the warranty period	According to the service terms, Siglent will offer another one year for the after-sales maintenance service
ES5	Two years after the warranty period	According to the service terms, Siglent will offer another two years for the after-sales maintenance service

## 2. Calibration services

After long-term use, oscilloscope will cause the deviation of measured value and waveform display, because of its work temperature and humidity. Siglent will restore the original performance and accuracy of factory setting to calibrate the deviation.

- Eliminate the error of measurement
- Restore the original performance and accuracy of the factory setting to the "new" state
- The upgrade of the firmware and the software
- Make the instruments comply with the standard of the ISO9001 quality management process
- Traceable calibration certificates







## About SIGLENT

SIGLENT is an international high-tech company, concentrating on R&D, sales, production and services of electronic test & measurement instruments.

SIGLENT first began developing digital oscilloscopes independently in 2002. After more than a decade of continuous development, SIGLENT has extended its product line to include digital oscilloscopes, isolated handheld oscilloscopes, function/arbitrary waveform generators, RF/MW signal generators, spectrum analyzers, vector network analyzers, digital multimeters, DC power supplies, electronic loads and other general purpose test instrumentation. Since its first oscilloscope was launched in 2005, SIGLENT has become the fastest growing manufacturer of digital oscilloscopes. We firmly believe that today SIGLENT is the best value in electronic test & measurement.

### Headquarters:

SIGLENT Technologies Co., Ltd  
Add: Bldg No.4 & No.5, Antongda Industrial  
Zone, 3rd Liuxian Road, Bao'an District,  
Shenzhen, 518101, China  
Tel: + 86 755 3688 7876  
Fax: + 86 755 3359 1582  
Email: sales@siglent.com  
Website: int.siglent.com

### USA:

SIGLENT Technologies America, Inc  
6557 Cochran Rd Solon, Ohio 44139  
Tel: 440-398-5800  
Toll Free: 877-515-5551  
Fax: 440-399-1211  
Email: info@siglent.com  
Website: www.siglentna.com

### Europe:

SIGLENT Technologies Germany GmbH  
Add: Staetzlinger Str. 70  
86165 Augsburg, Germany  
Tel: +49(0)-821-666 0 111 0  
Fax: +49(0)-821-666 0 111 22  
Email: info-eu@siglent.com  
Website: www.siglenteu.com

Follow us on  
Facebook: SiglentTech



modification date:2024-05